

ce plan est à 80% de la taille de la maquette

TOIT 1

**COLLER
15A**

1

COLLER 10

CONCEPTION ET REALISATION DERRICK83
USAGE COMMERCIAL INTERDIT

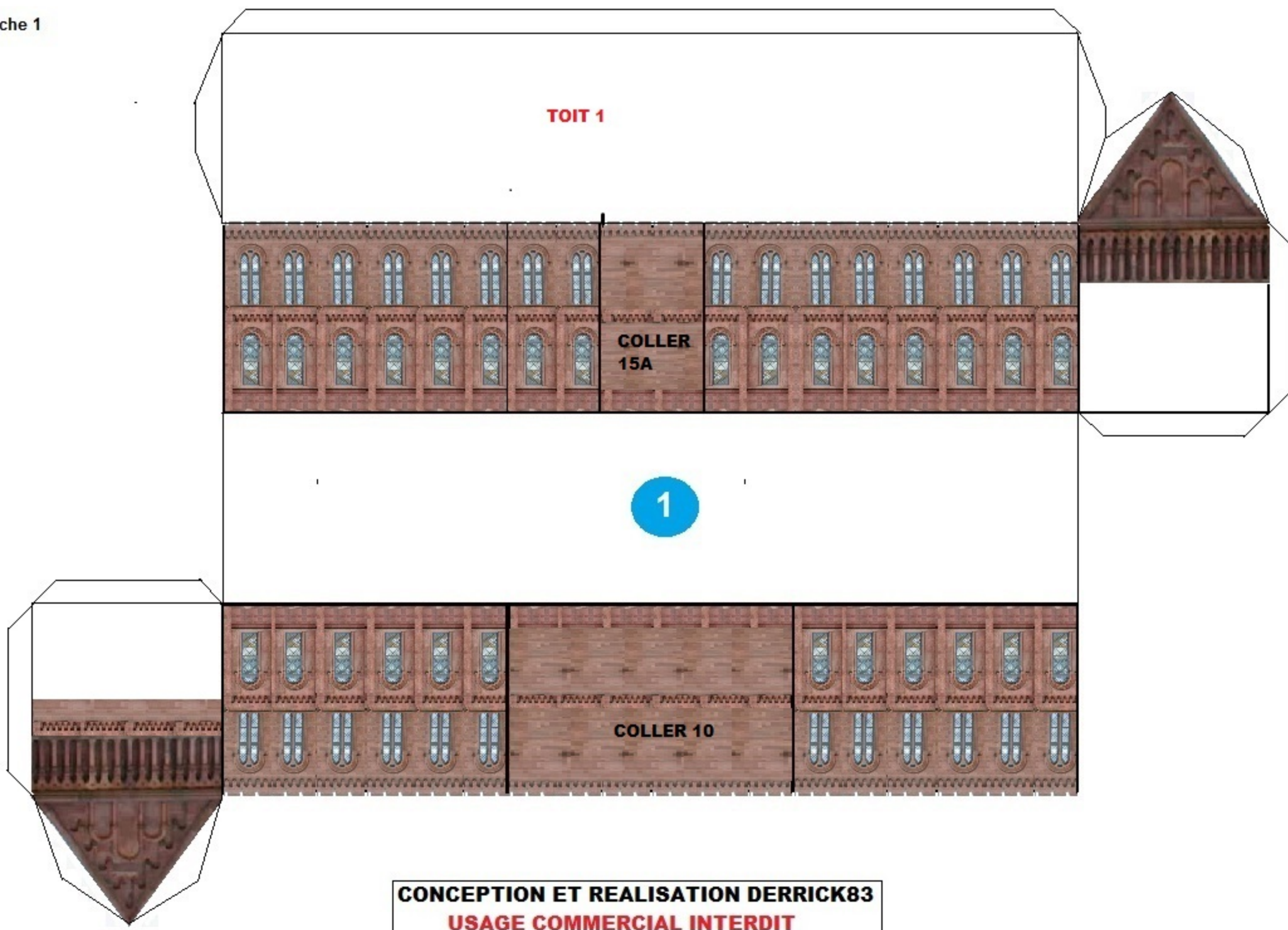

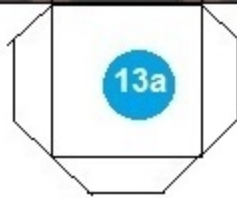
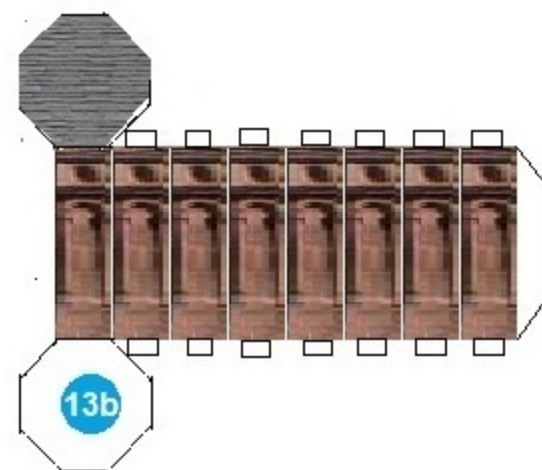
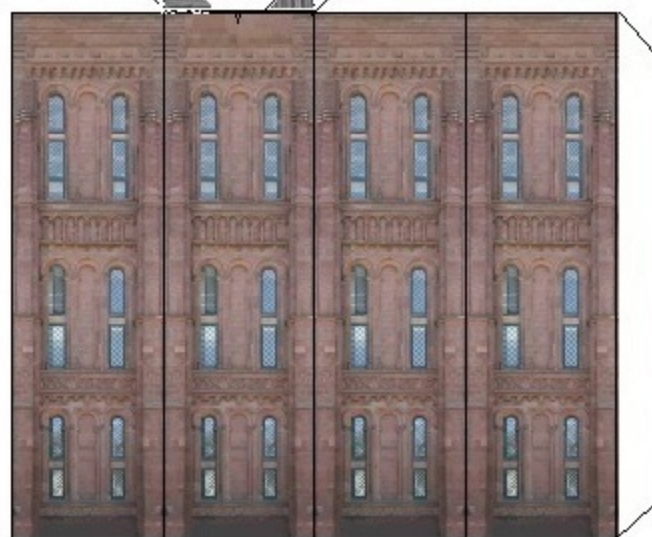
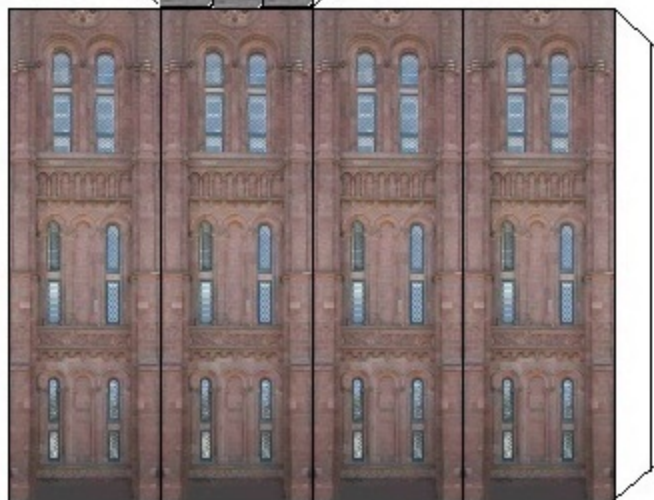
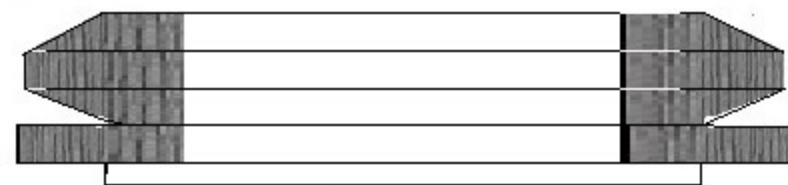
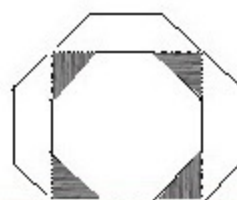
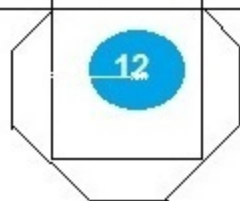
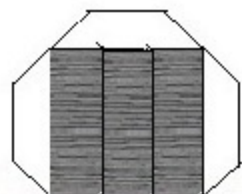
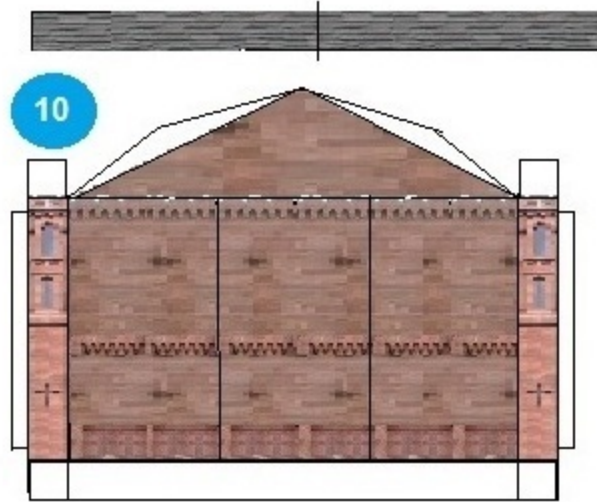
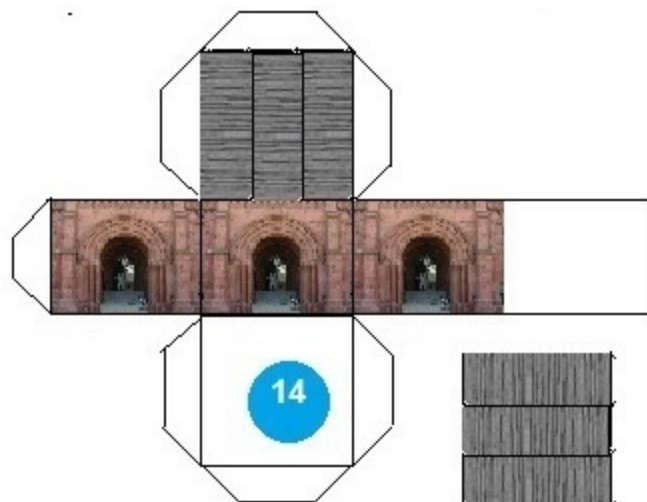
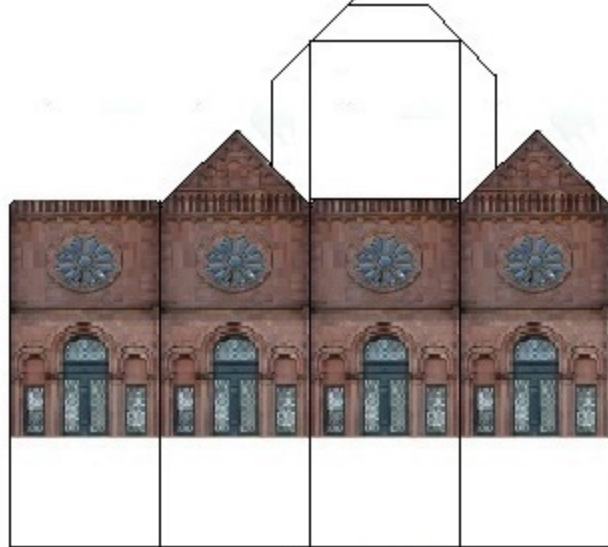

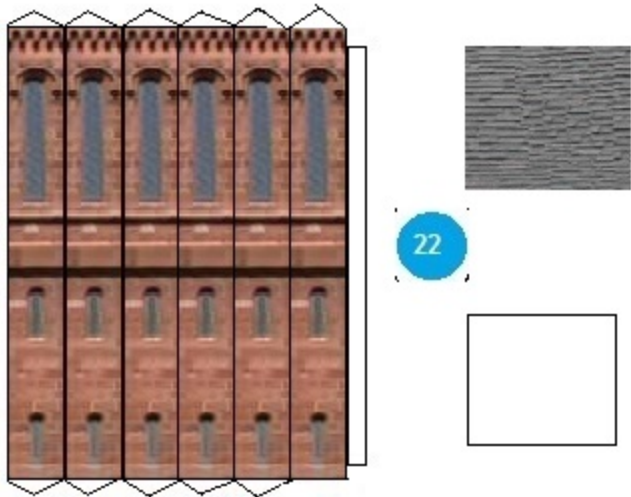
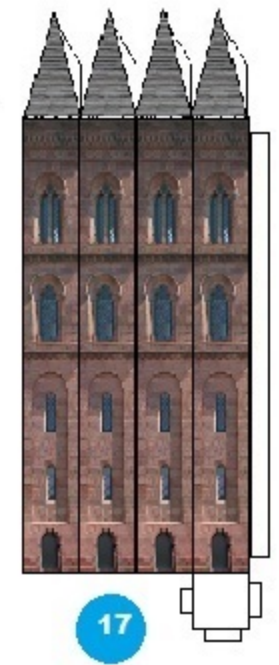
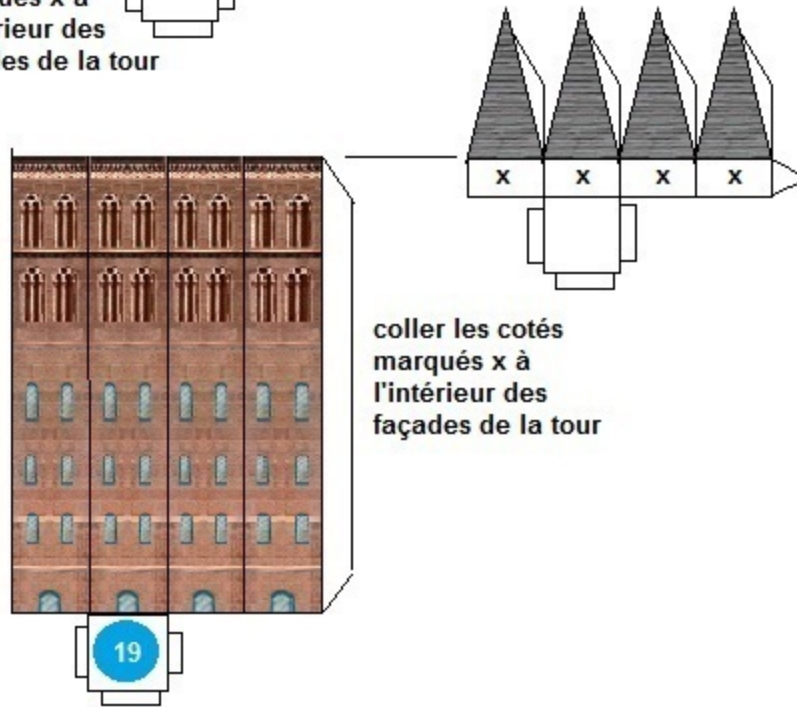
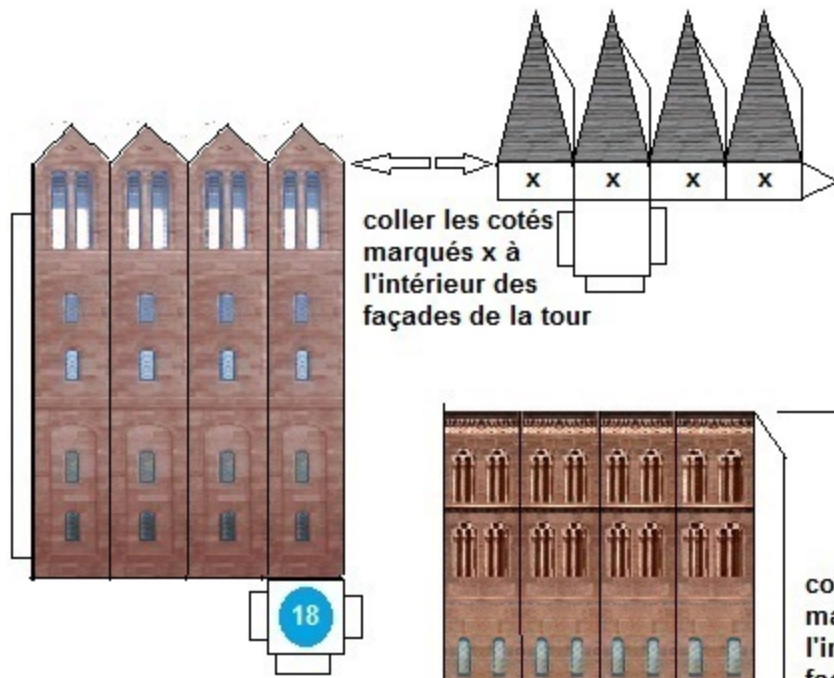

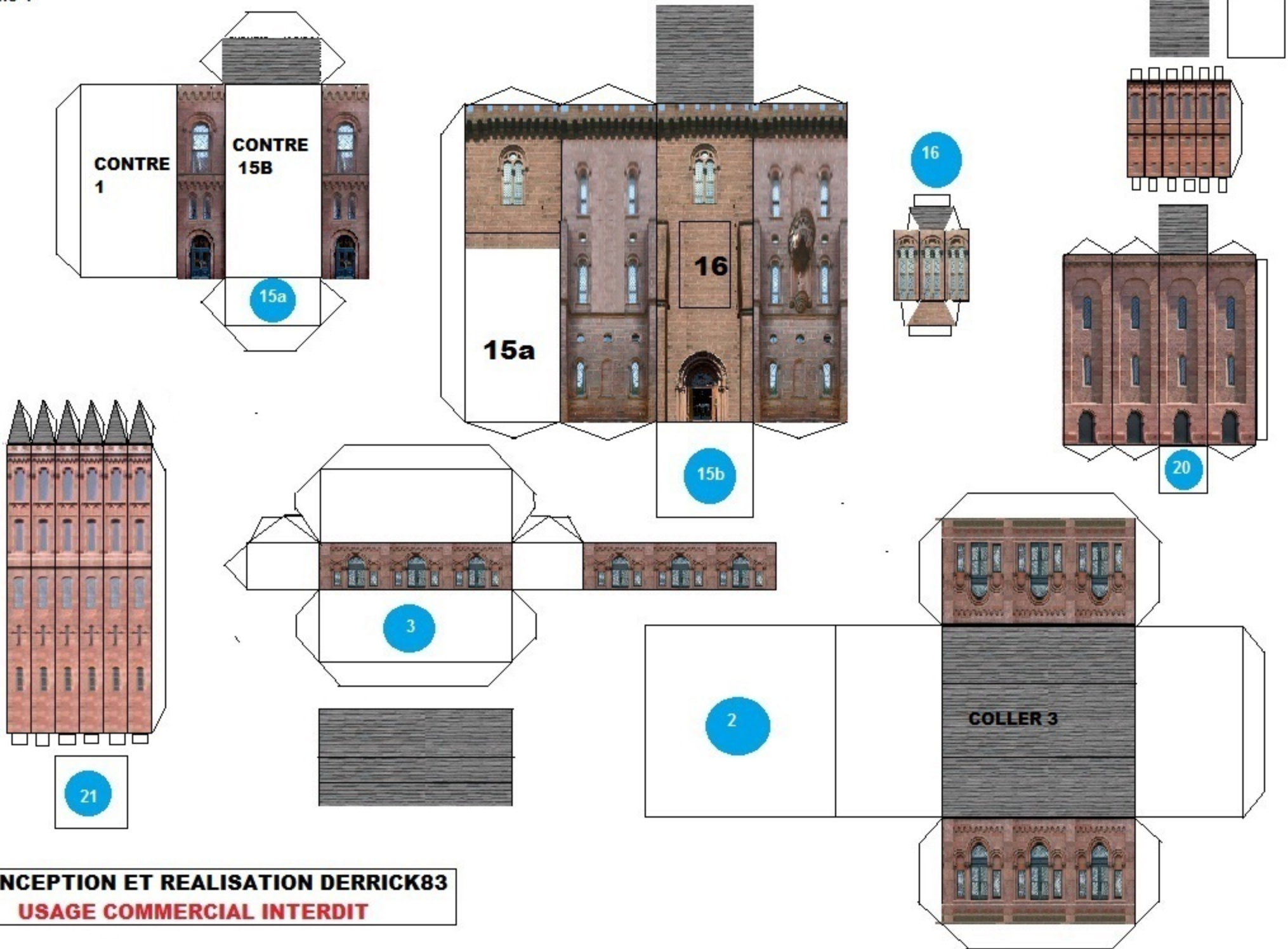

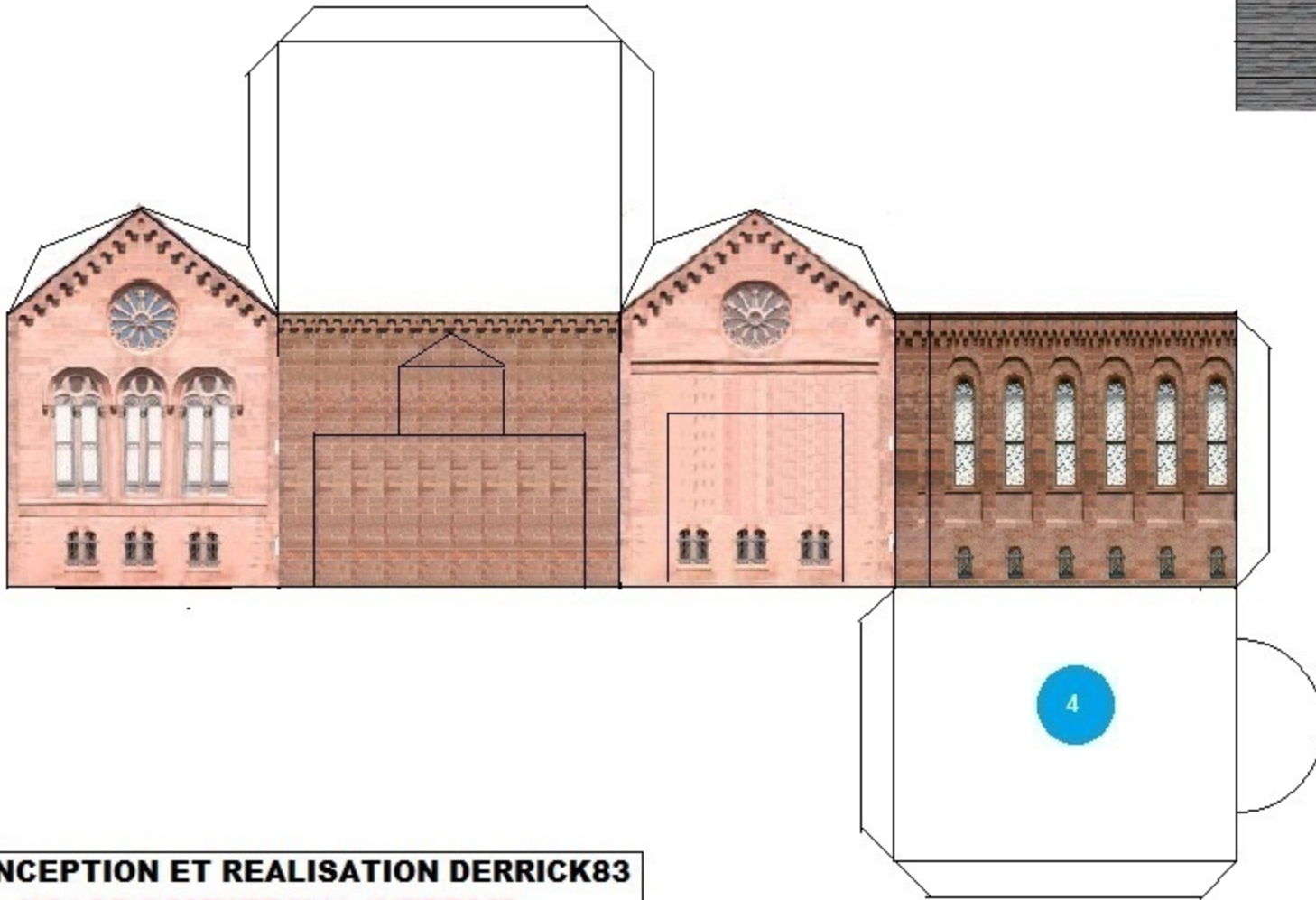
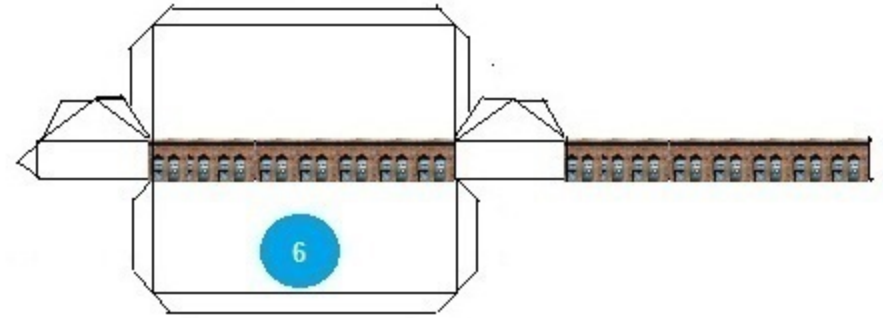
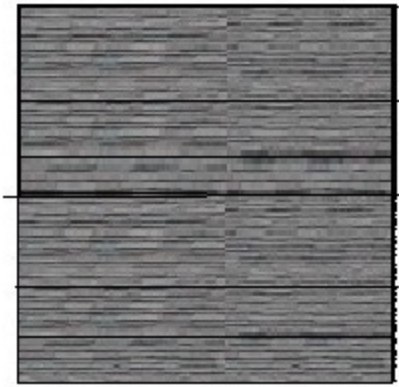

COLLER TOIT 3

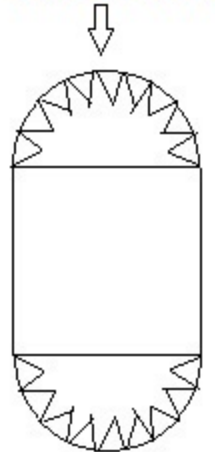

CONCEPTION ET REALISATION DERRICK83
USAGE COMMERCIAL INTERDIT

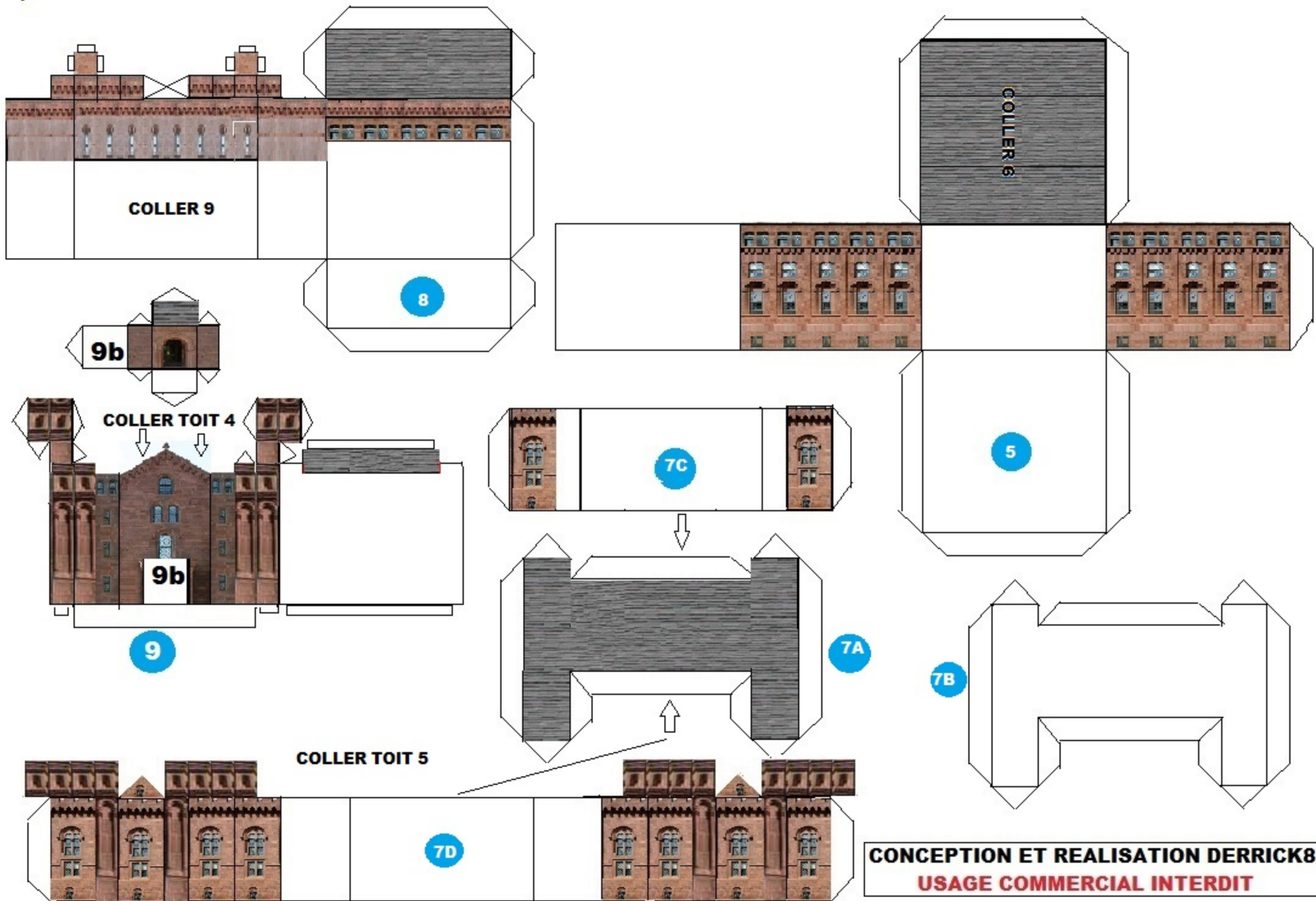

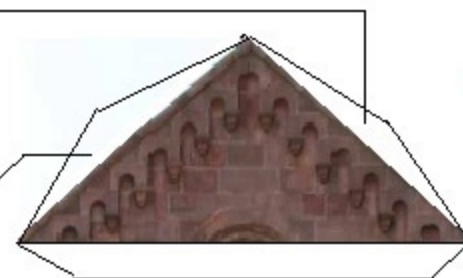
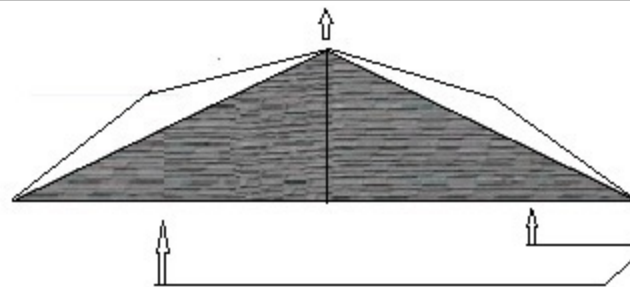
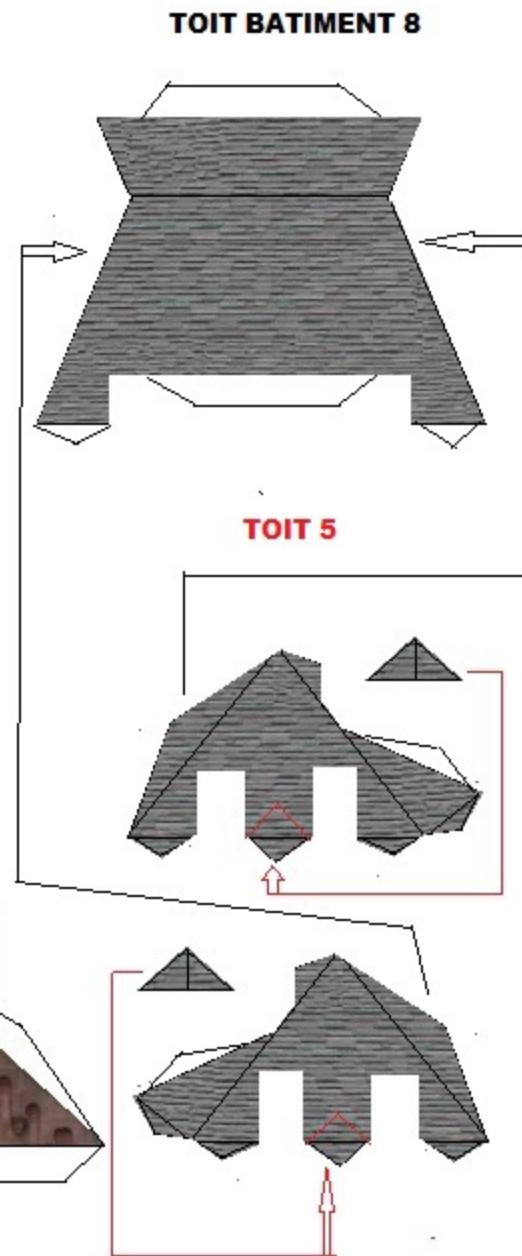
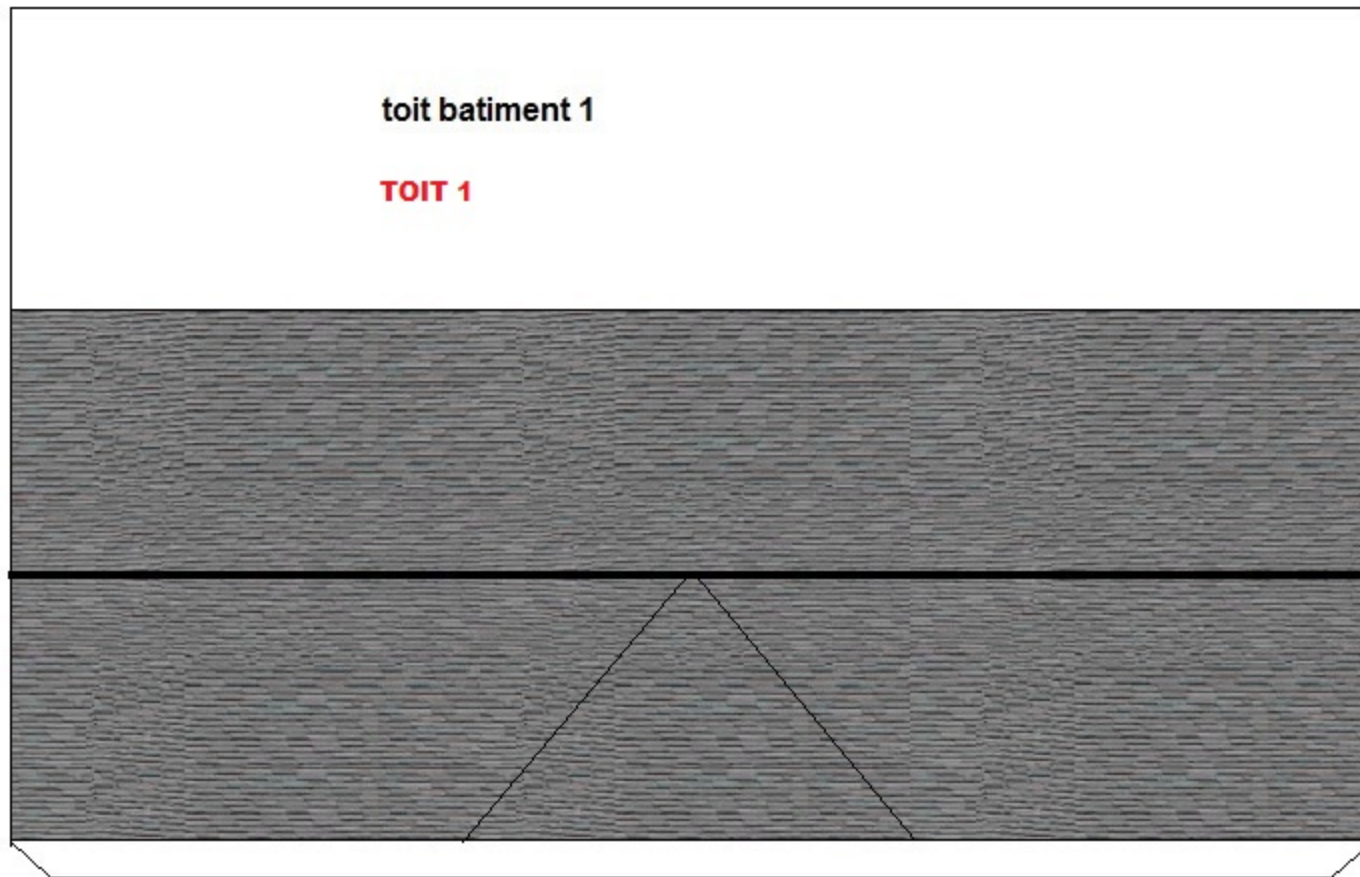

CONCEPTION ET REALISATION DERRICK83
USAGE COMMERCIAL INTERDIT

smithsonians socle 1/2

