

MATCH ARCHITECTURE

Taj Mahal



48

MATCH ARCHITECTURE

An immense mausoleum of white marble built in Agra between 1631 and 1644 by order of the Mughal emperor Shah Jahan in memory of his favorite wife, the Taj Mahal is the jewel of Muslim art in India and one of the universally admired masterpieces of the world's heritage.

Taj Mahal

Taj Mahal

Le Taj Mahal, immense mausolée de marbre blanc, a été érigé à Agra entre 1631 et 1648, sur l'ordre de l'empereur moghol, le Shah Jahan, en mémoire de son épouse favorite. L'un de l'art musulman de l'Inde, il est l'un des chefs-d'œuvre universellement admirés du patrimoine mondial.

Taj Mahal

Un immense mausolée de marbre construit en Agra à partir de l'empereur de Moghul, Shah Jahan, en honra a su esposa favorita, entre 1631 y 1648, el Taj Mahal es la joya del arte musulmán en India. Y una de las maravillas del mundo más admiradas.

Taj Mahal

Ein riesiges Mausoleum aus weißem Marmor, das zwischen 1631 und 1644 in Auftrag des Großmoguls Shah Jahan in Agra zum Andenken an seine Lieblingsfrau gebaut wurde. Das Taj Mahal ist ein Juwel muslimischer Kunst in Indien und ein allgemein bewundertes Meisterwerk des Weltkulturerbes.

Taj Mahal

De Taj Mahal is een juwelen van islamitische kunst in India en een zeer bekend te de hele wereld bekend monument. Het is een monument misschien in het algemeen, gebouwd in Agra tussen 1631 en 1640 in opdracht van Shah Jahan, de mogolkeizer, ter nagedachtenis van zijn geliefde vrouw.

Taj Mahal

Il Taj Mahal, un immenso mausoleo di marmo bianco costruito ad Agra tra il 1631 ed il 1648 per ordine dell'imperatore Moghul, Shah Jahan, in memoria della moglie favorita, è il gioiello dell'arte musulmana dell'India e uno dei capolavori più ammirati dell'arte mondiale.

タージマハール

ムガル帝国皇帝シャール・ジャハーンが最愛の妻、タージマハールを悼び、アグラに建築した、白大理石の大理石造りの巨大な墓廟。建築には1631年から1648年までと長い年月を費やされた。インドにおけるイスラム美術の宝珠で、世界遺産の傑作として全世界が誇るものの一つ。

MATHEMATIC ARCHITECTURE

PLANS • PLANOS • PIANI • ZEICHNUNGEN • PLANNEN • 設計図

Contents:

- 1 assembly board with clear acetate sheet
- 4 clips
- 1 MICROBEAM center
- 7500 MICROBEAMS (2.18"/73 mm)
- 2 handles of wood glue (4 oz/120 ml)
- 1 MICROBEAM designers plan
- instructions

Contenu :

- 1 planche d'assemblage avec feuille d'acétate transparente
- 4 clips
- 1 coupe-MICROBAMBIERS
- 7 500 MICROBAMBIERS (53 mm/2.18")
- 2 handles de colle à bois (120 ml/4 oz)
- 1 plan à MICROBAMBIERS
- plans
- instructions

Contenido:

- 1 tablero de montaje con hoja de acetato transparente
- 4 pinzas
- 1 cortacortinillas
- 7500 MICROBAMBIERS (53 mm/2.18")
- 2 botes de pegamento de madera (120 ml/4 oz)
- 1 plan para MICROBAMBIERS
- planes
- instrucciones

Contento:

- 1 tavola d'assemblaggio con foglio di acetato trasparente
- 4 pinzette
- 1 tagliatore per MICROBAMBI
- 7500 MICROBAMBI (53 mm/2.18")
- 2 bottiglie di colla per legno (120 ml/4 oz)
- 1 planis per MICROBAMBI
- plani
- istruzioni

Inhalt:

- 1 montageplatte mit durchsichtigem Acetatblatt
- 4 clips
- 1 MICROBAMBIERSchneider
- 7500 MICROBAMBIERS (53 mm/2.18")
- 2 Flaschen Holzleim (120 ml/4 oz)
- 1 planis für die MICROBAMBIERS
- Zeichnungen
- Werkzeuge

Inhoud:

- 1 montageplaat met transparant held van acetaat
- 4 klampen
- 1 snijder voor MICROBAMBIERS
- 7500 MICROBAMBIERS (53 mm/2.18")
- 2 flessen houtlijm (120 ml/4 oz)
- 1 planis voor MICROBAMBIERS
- plannen
- gebruiksaanwijzingen

内容:

- 1 透明シートと組み立てボード
- 4 クリップ
- 1 マイクロビームカッター
- 7500 マイクロビーム (53mm/2.18")
- 2 木工用接着剤 (120ml/4oz)
- 1 マイクロビーム設計シート
- 設計図
- 使用説明書

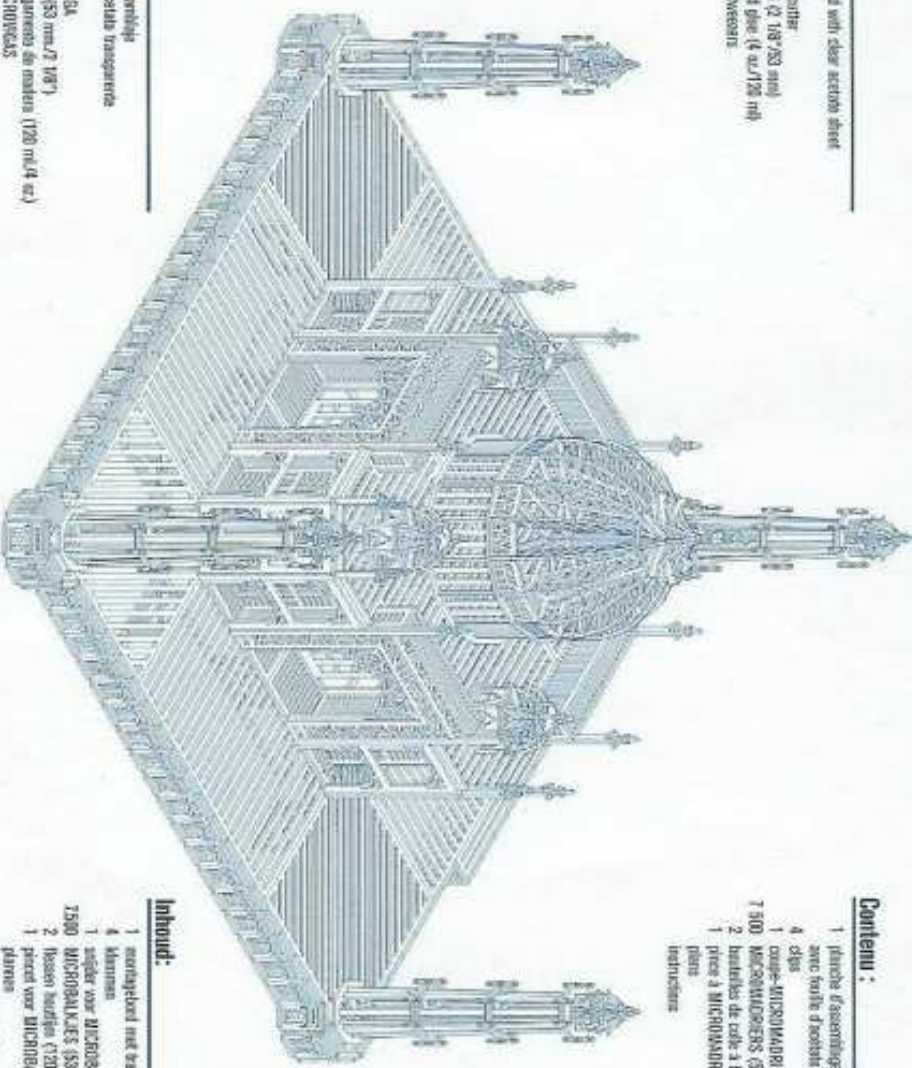



© 2024 Matchitecture, Inc.

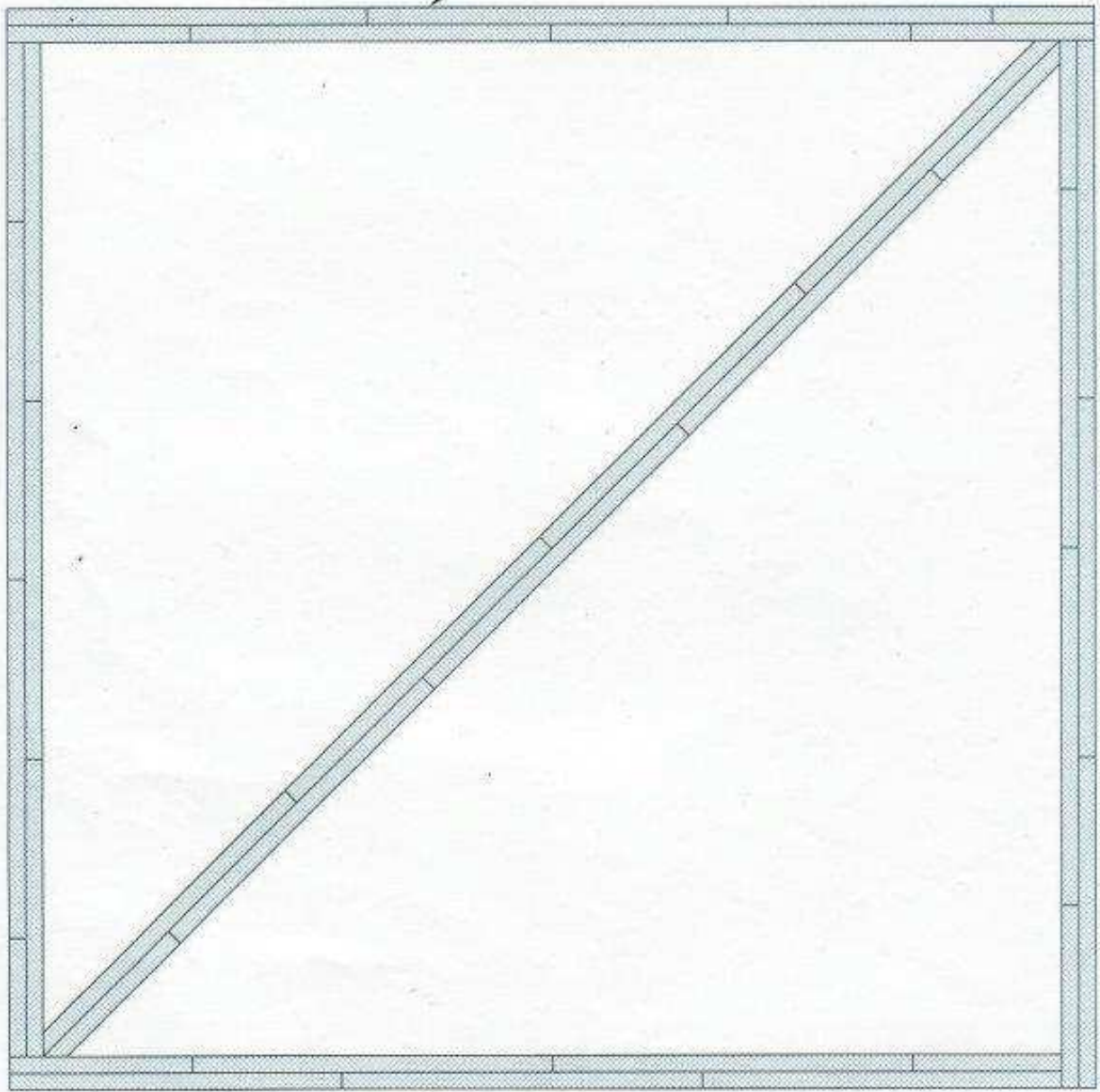

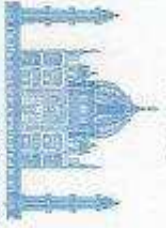

© 2004 Bevan Inc.

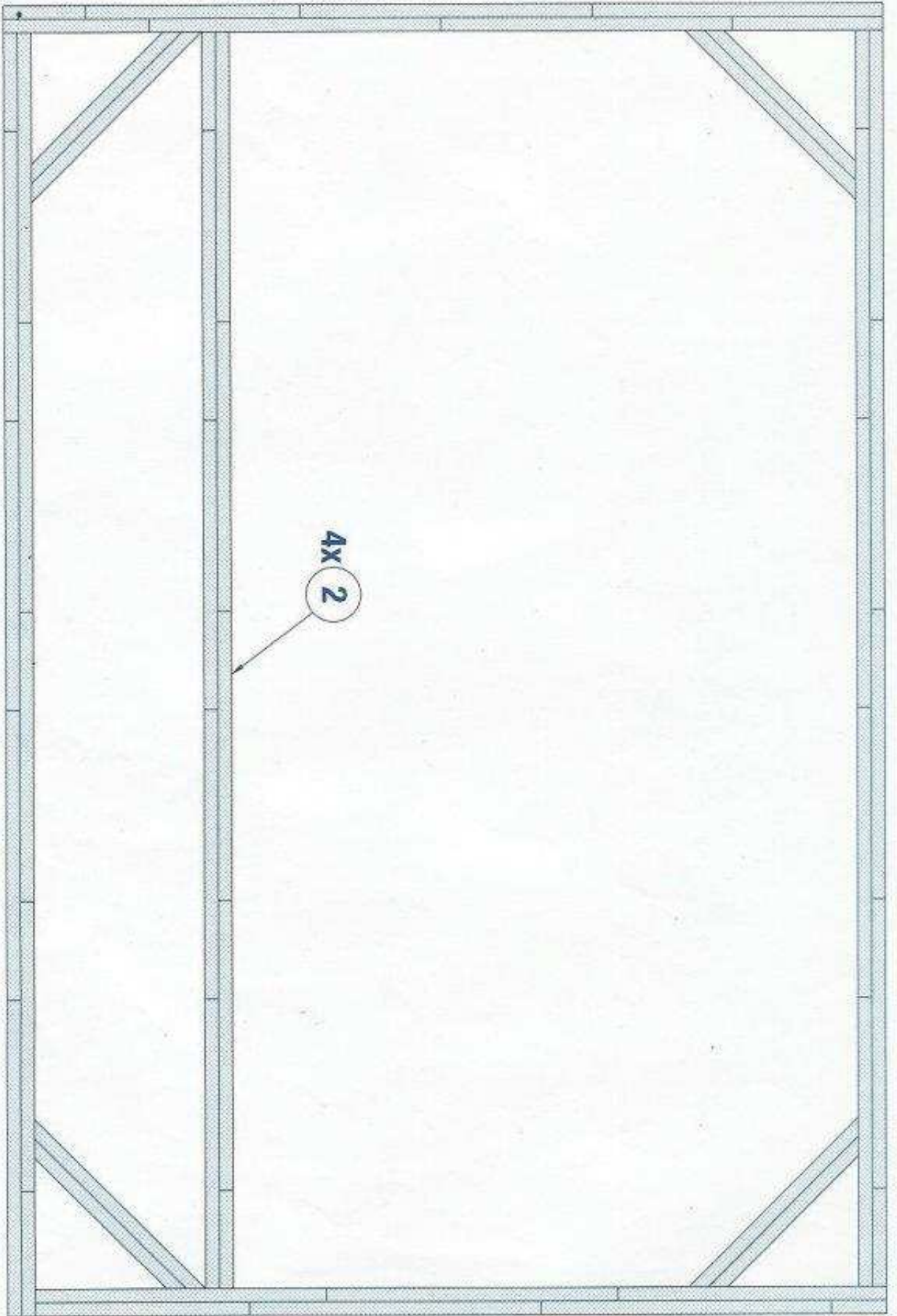

4x2

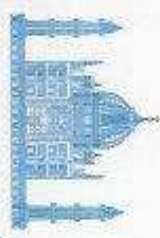
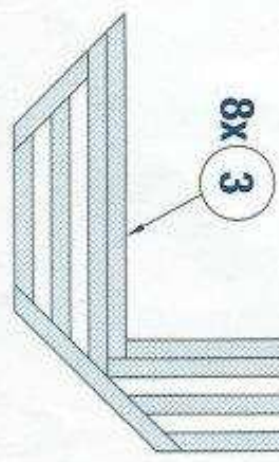
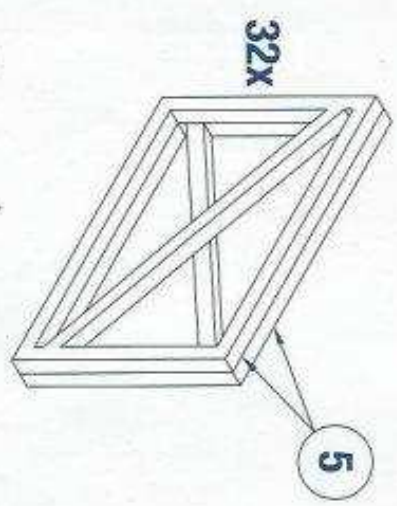
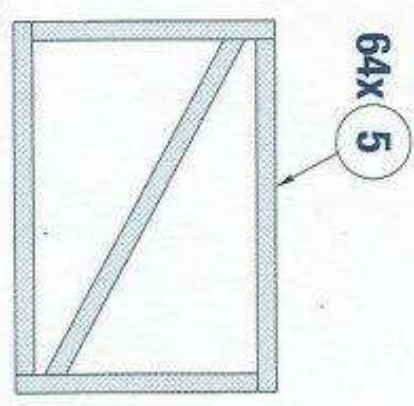
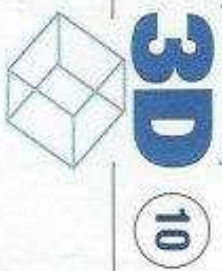
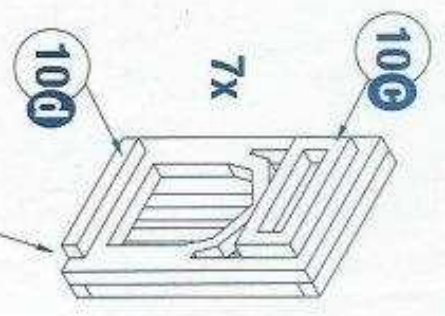
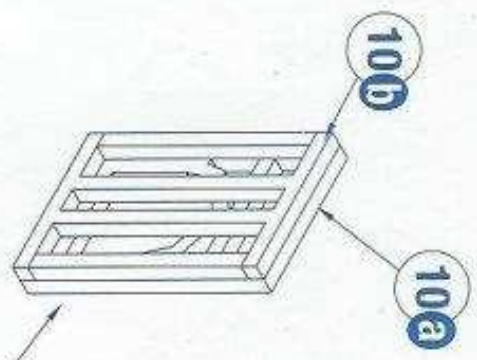
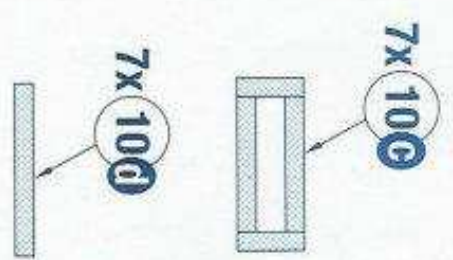
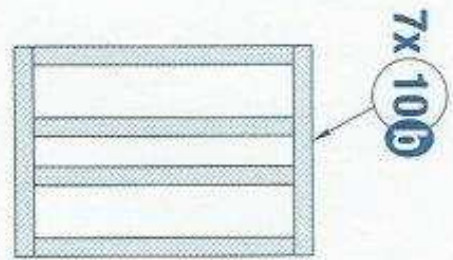
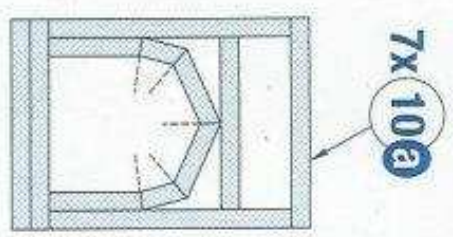

© 2004 Bogen Inc.

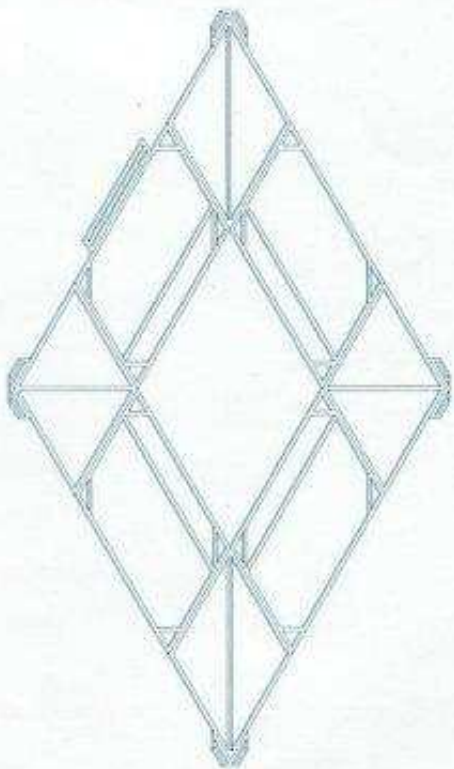
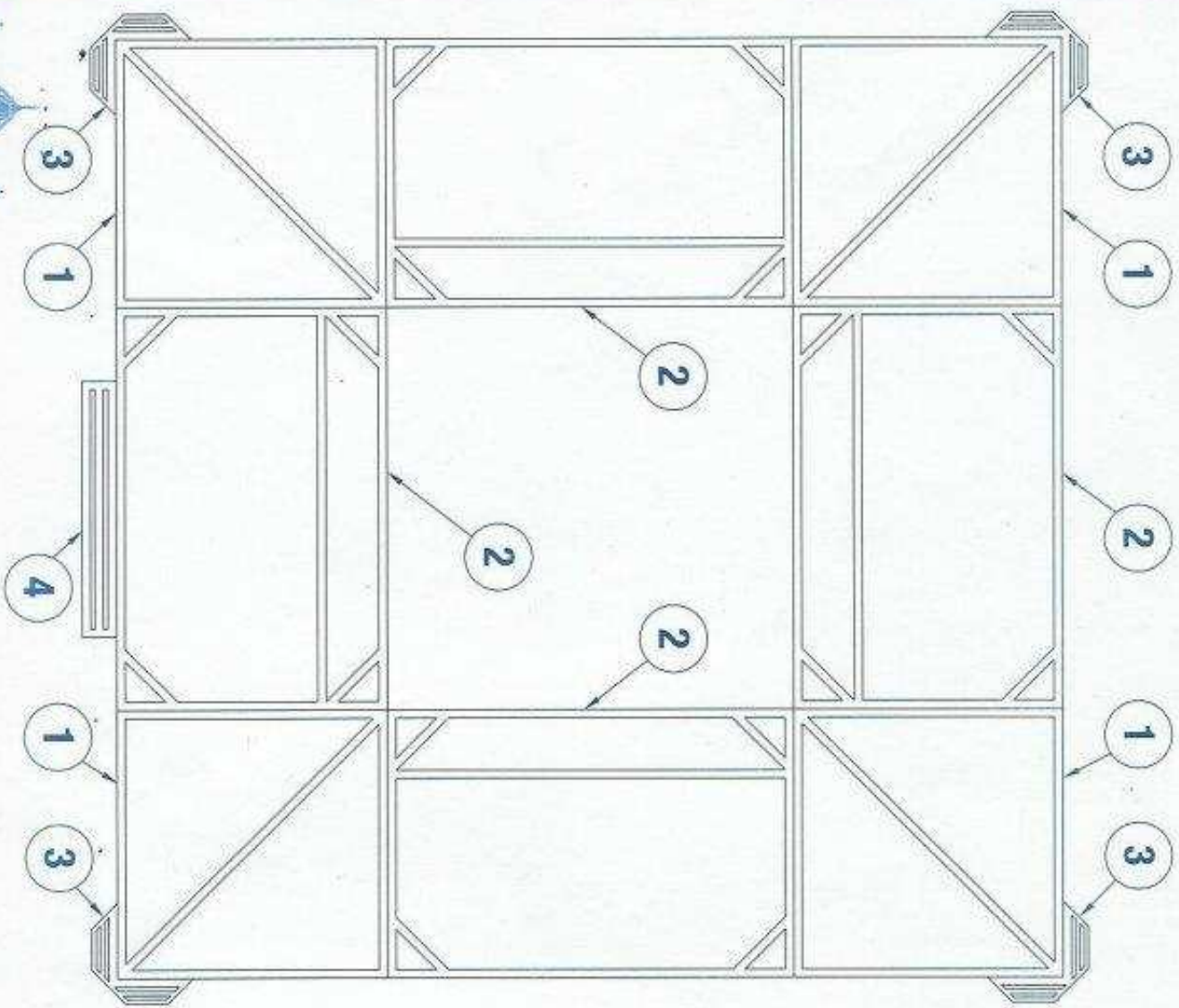

3D



© 2004 Bogen, Inc.

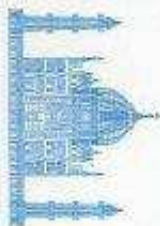

© 2004 Matchitecture Inc.

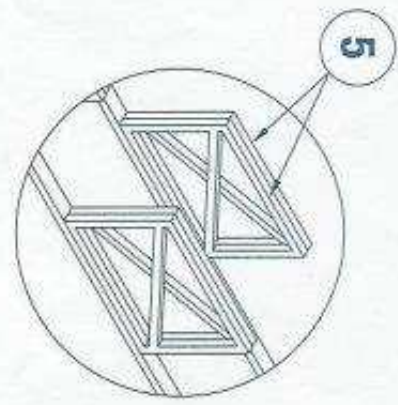
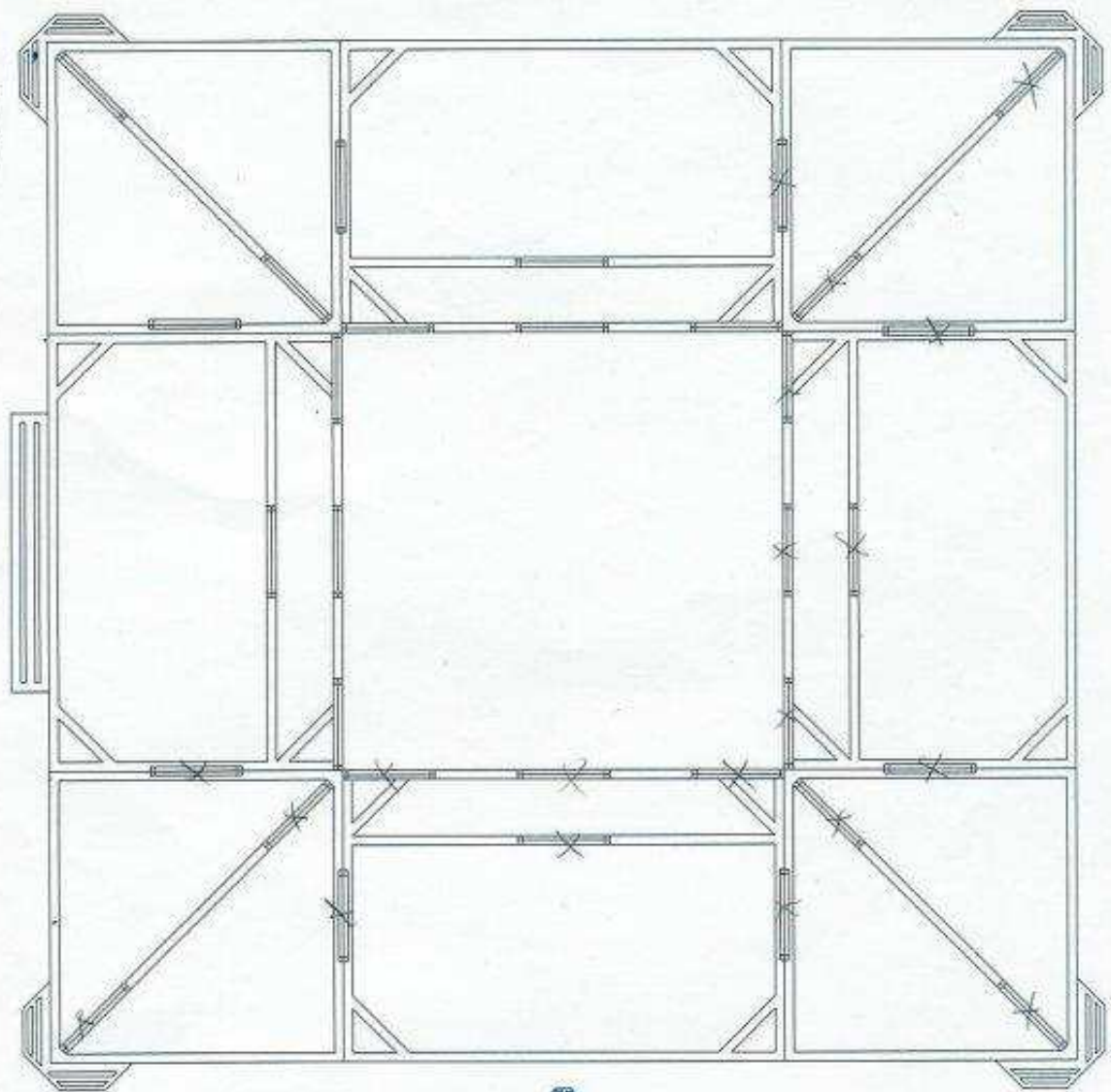

5

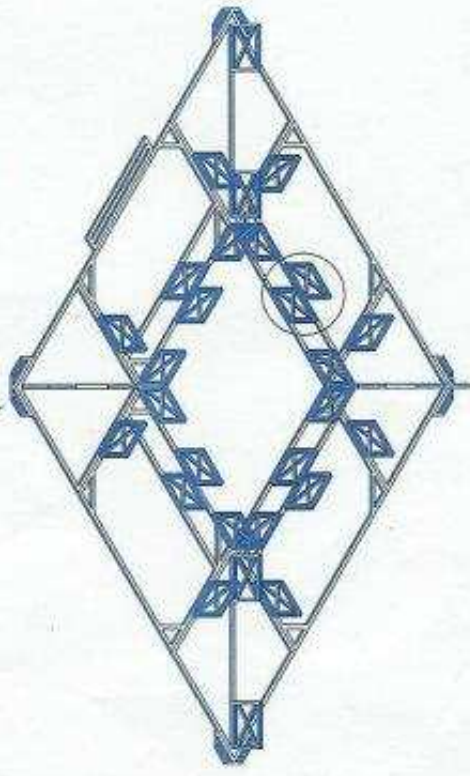

3D

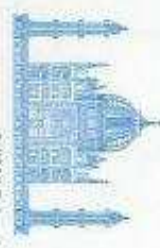
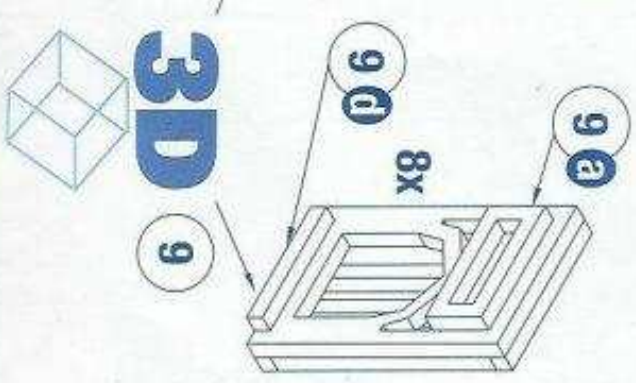
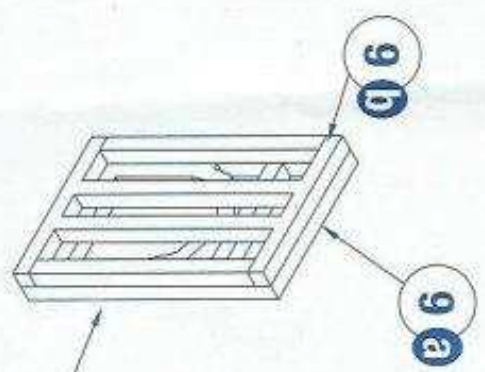
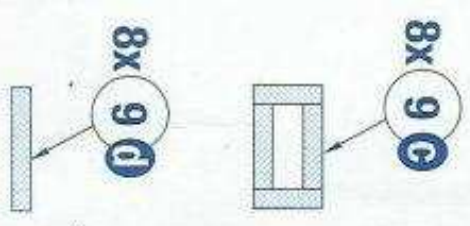
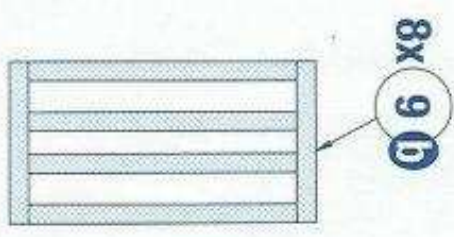
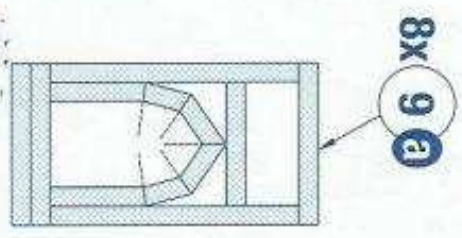
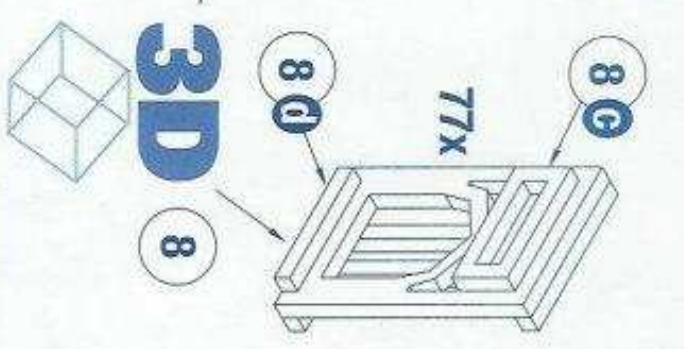
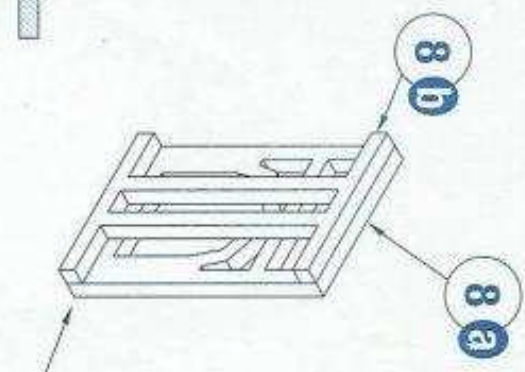
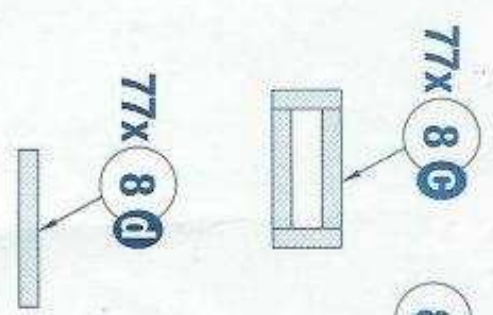
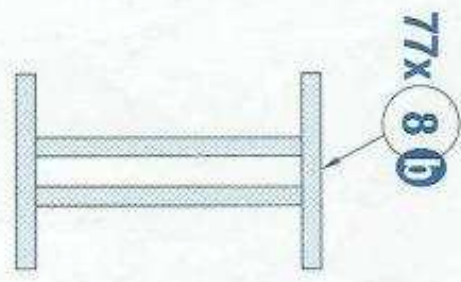
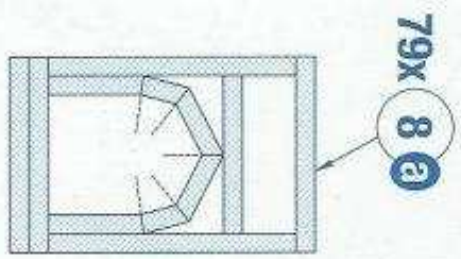



2x 4

4x 6

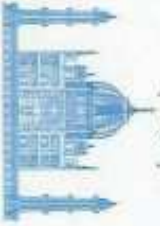
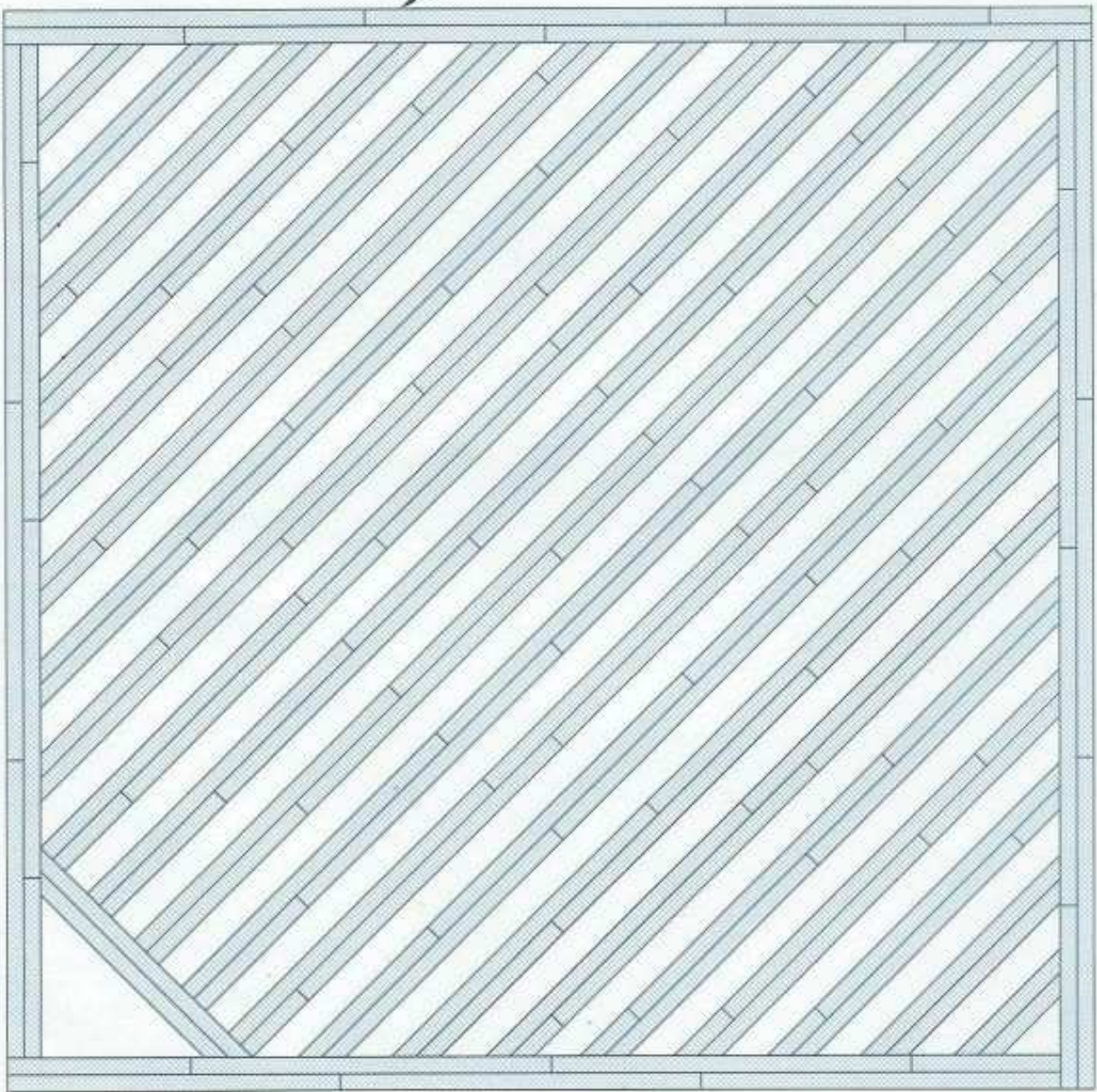

© 2004 Bevan, Inc.

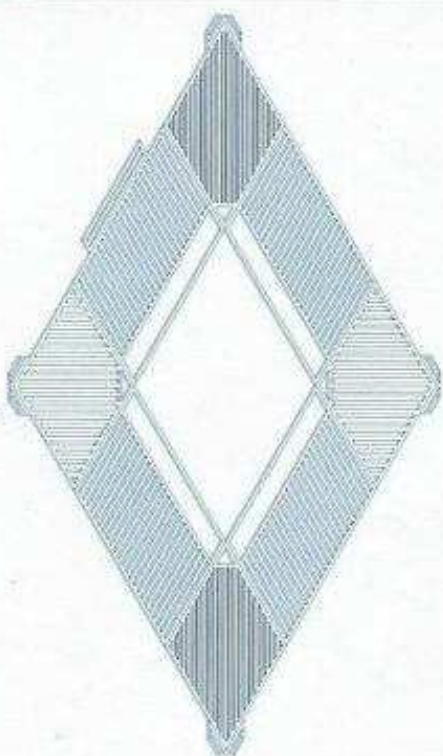
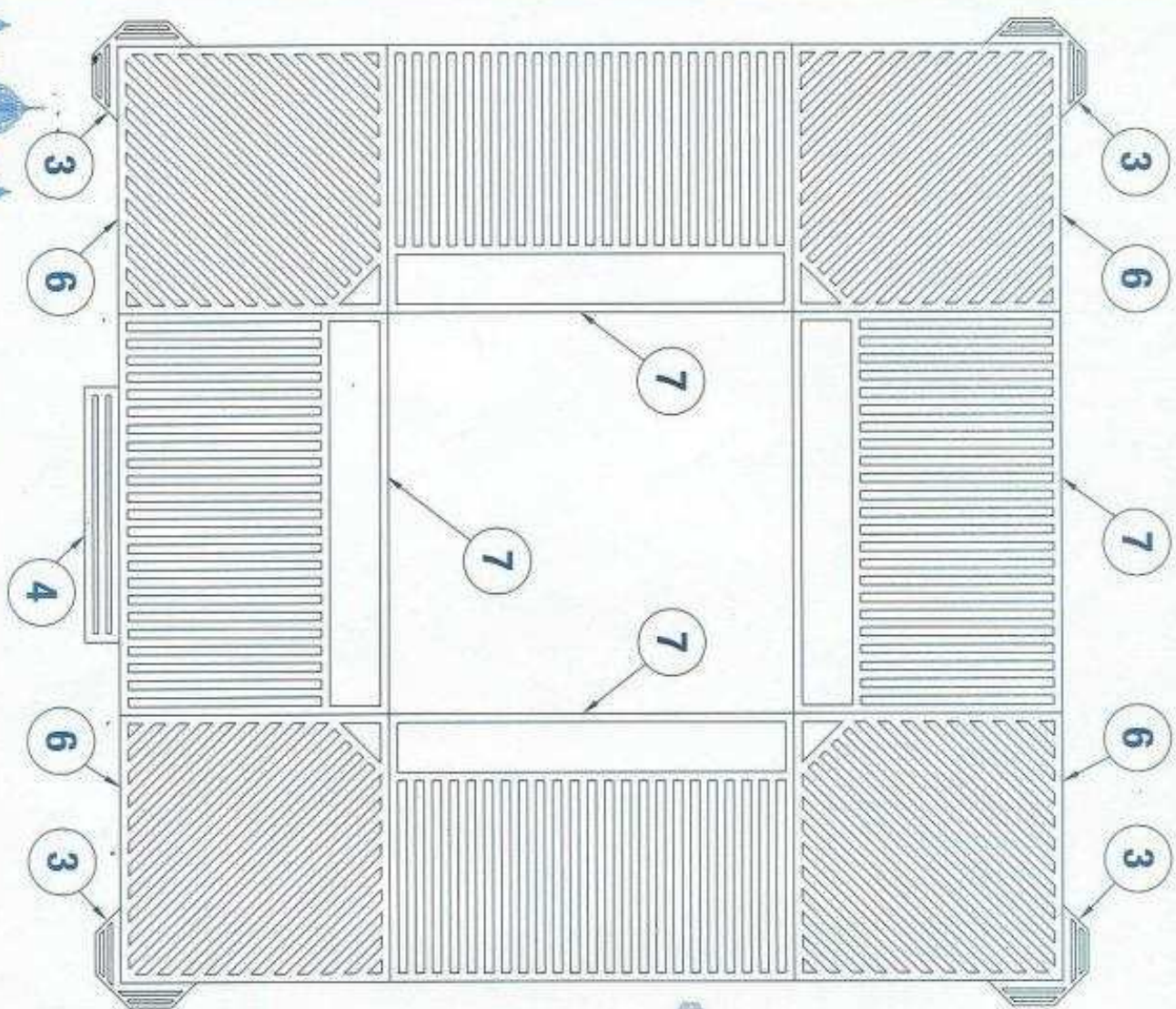

3D



© 2004 Blythe, Inc.

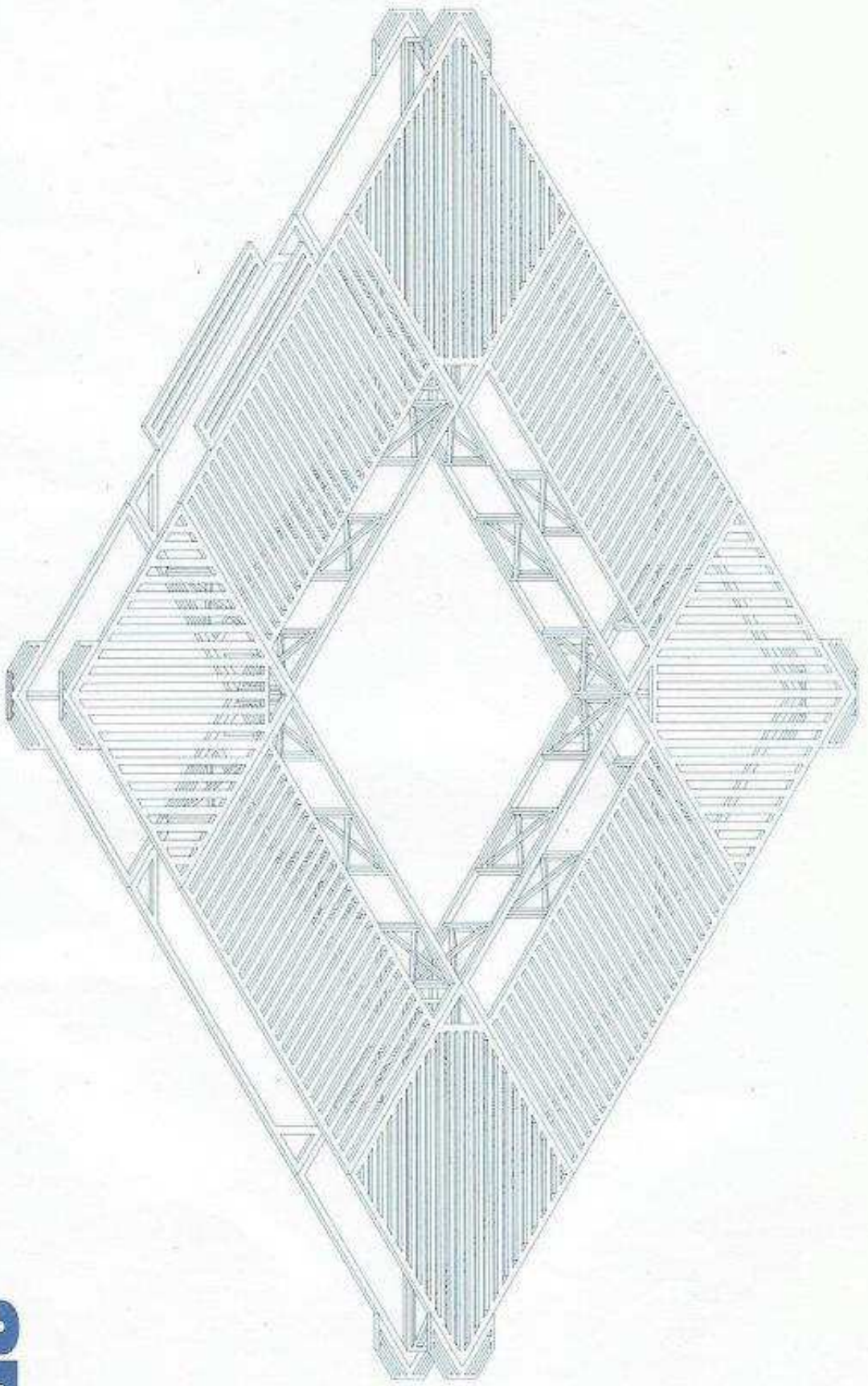

© 2004 BENTON & BOWLES INC.



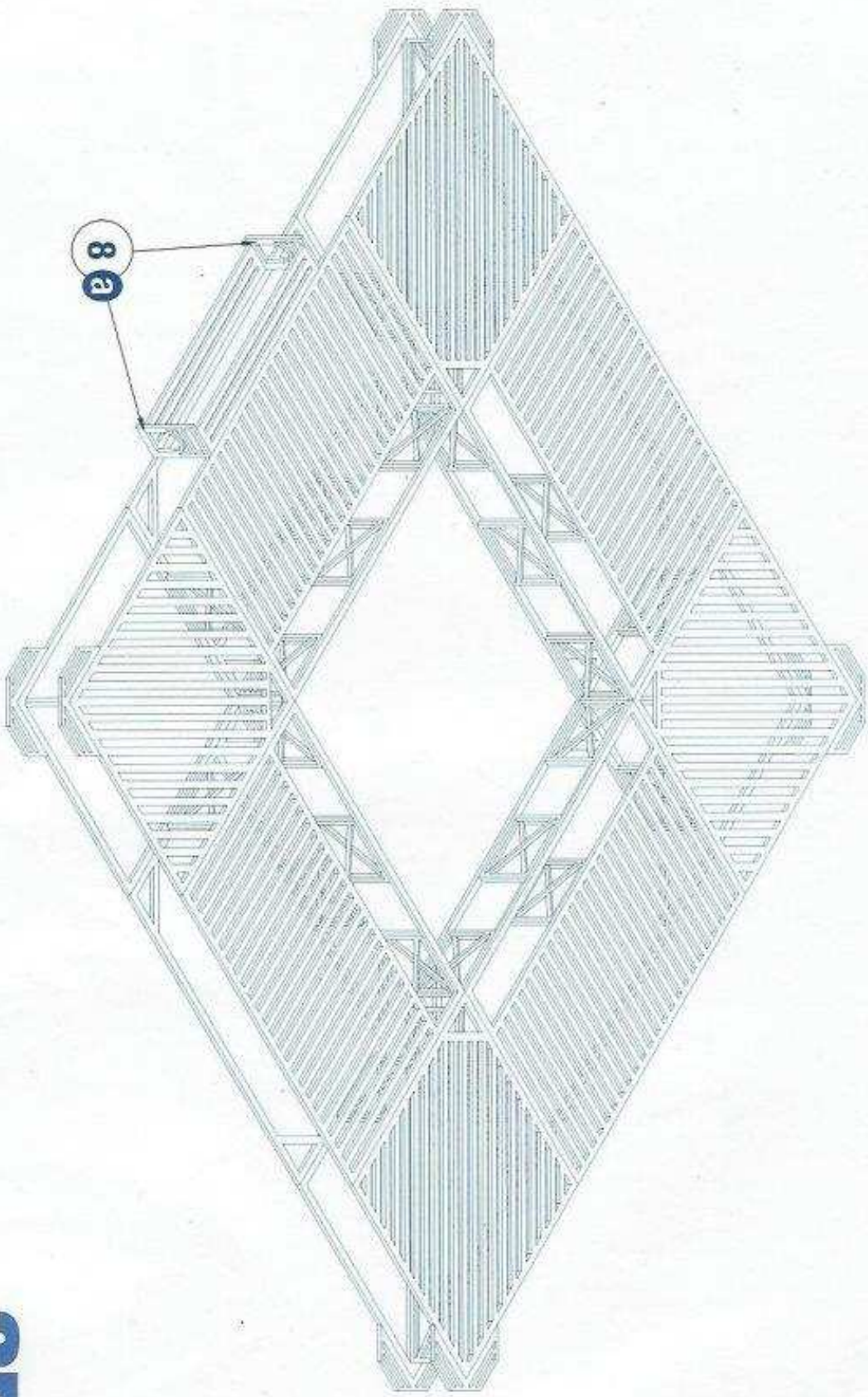

8 a



© 2004 Bepko Inc.



© 2004 Begem Inc.

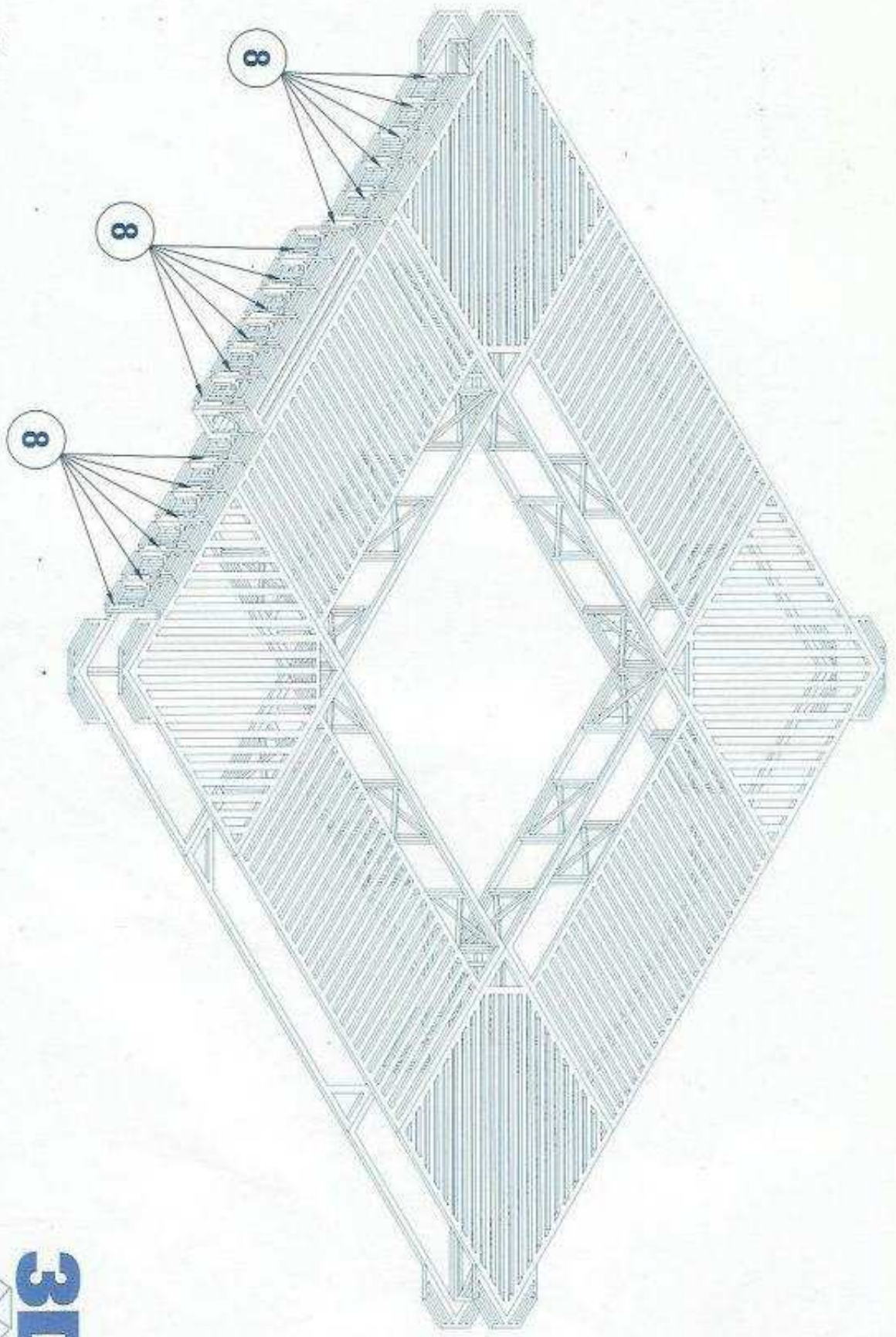

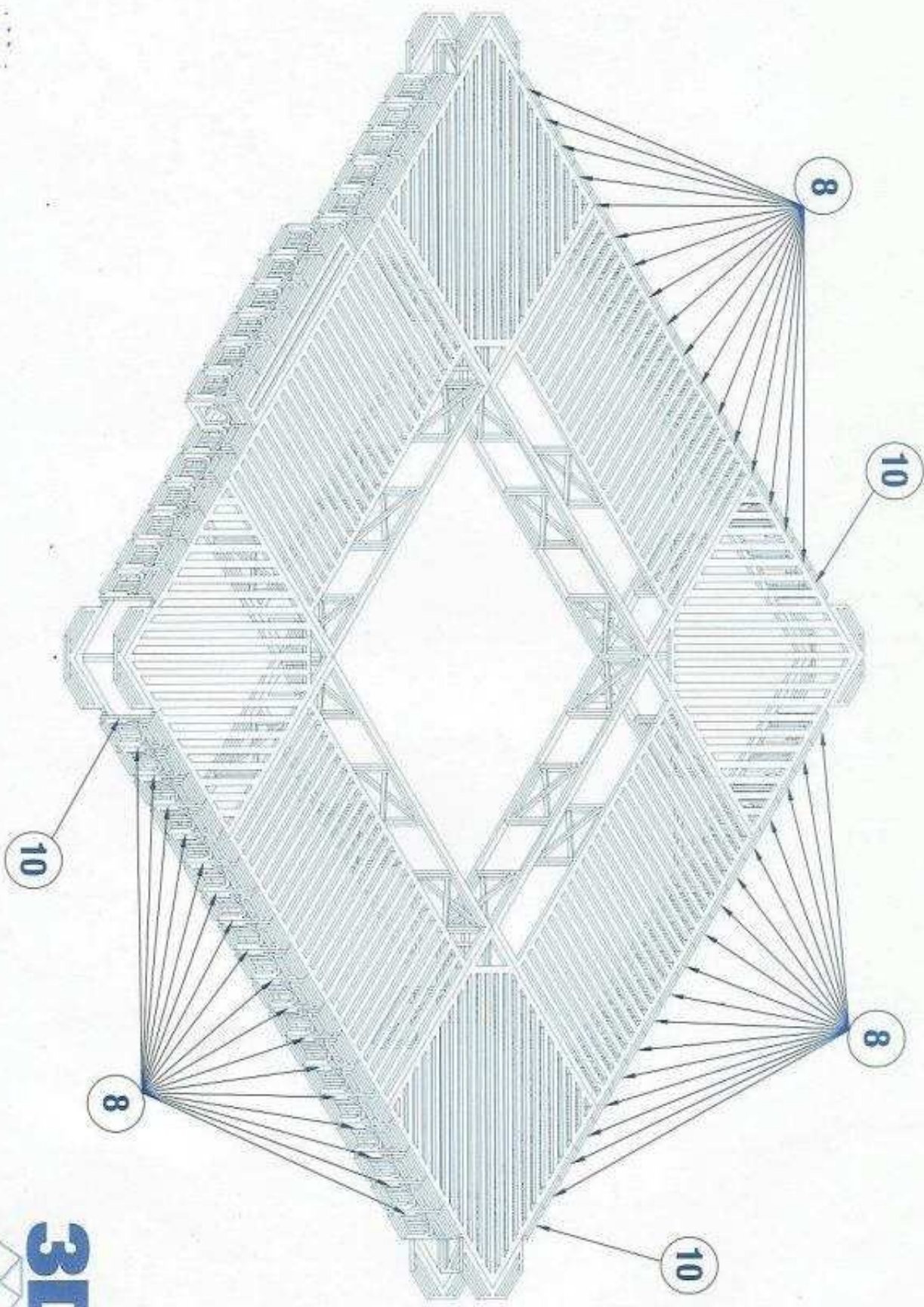

© 2004, Deyan, Inc.

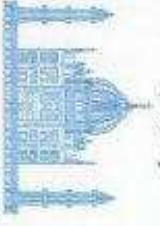
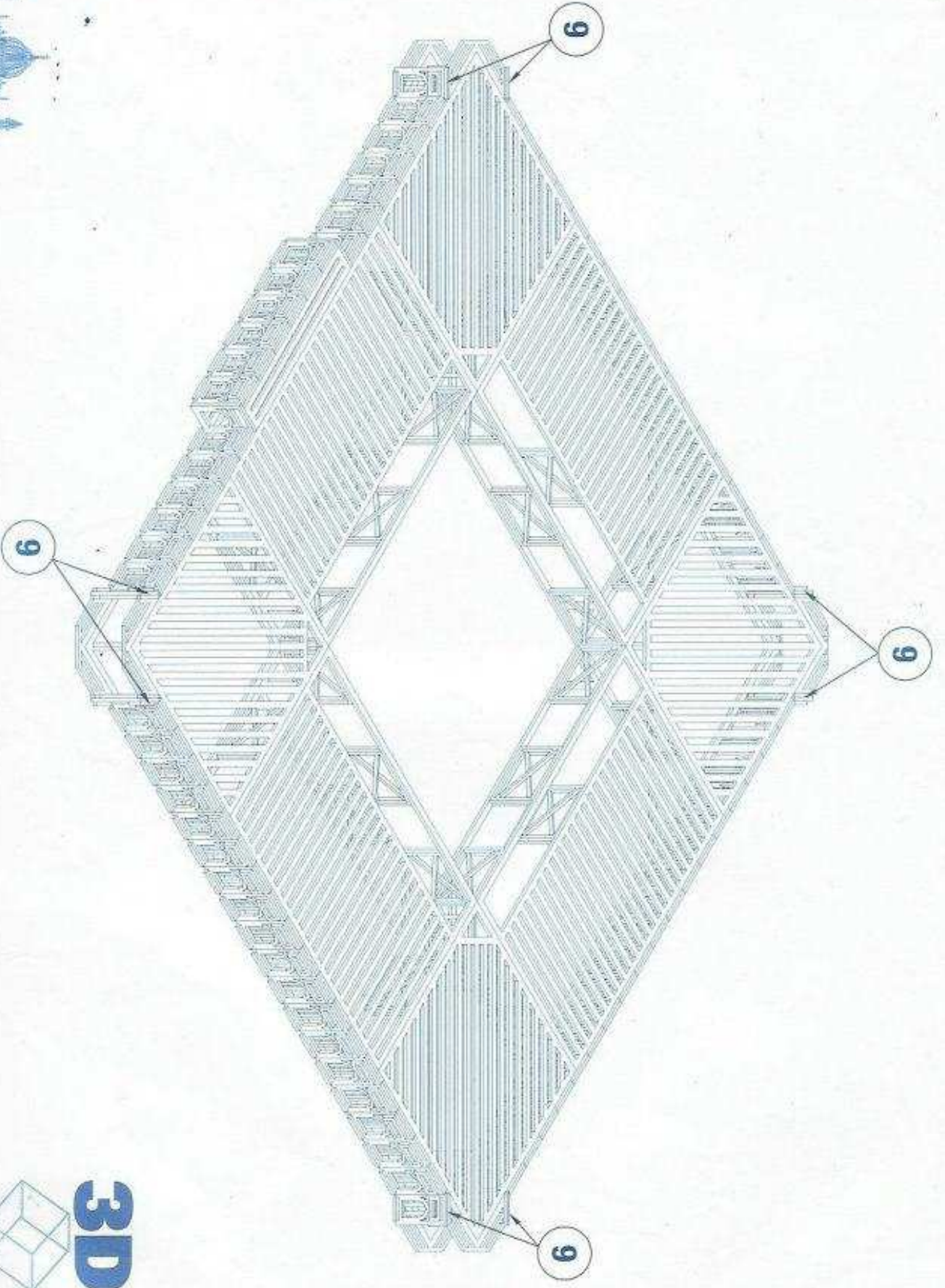

© 2004 Bolyard Inc.



© 2004 Matchitecture Inc.

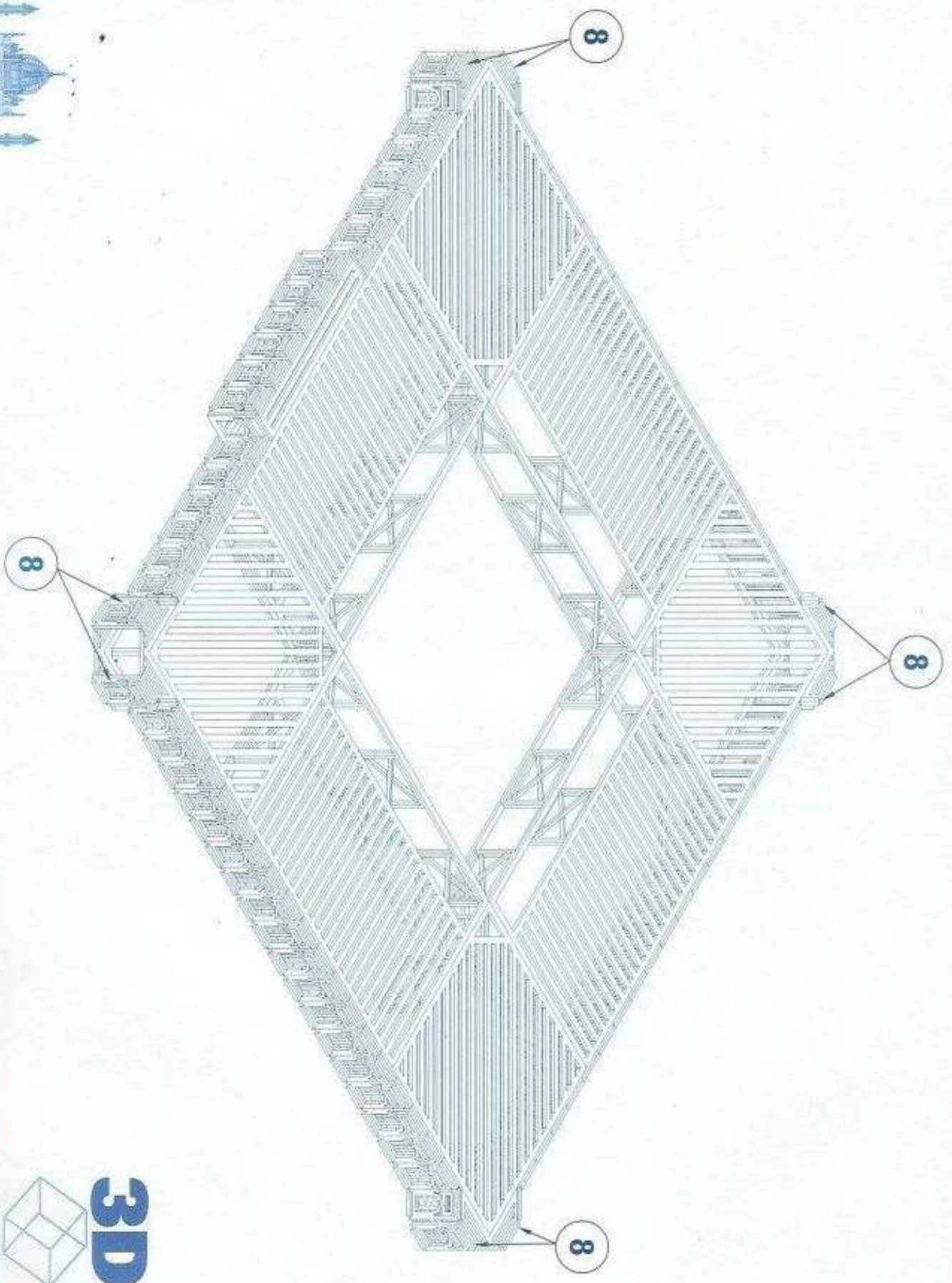

MATCHITECTURE 15 /ISS

3D



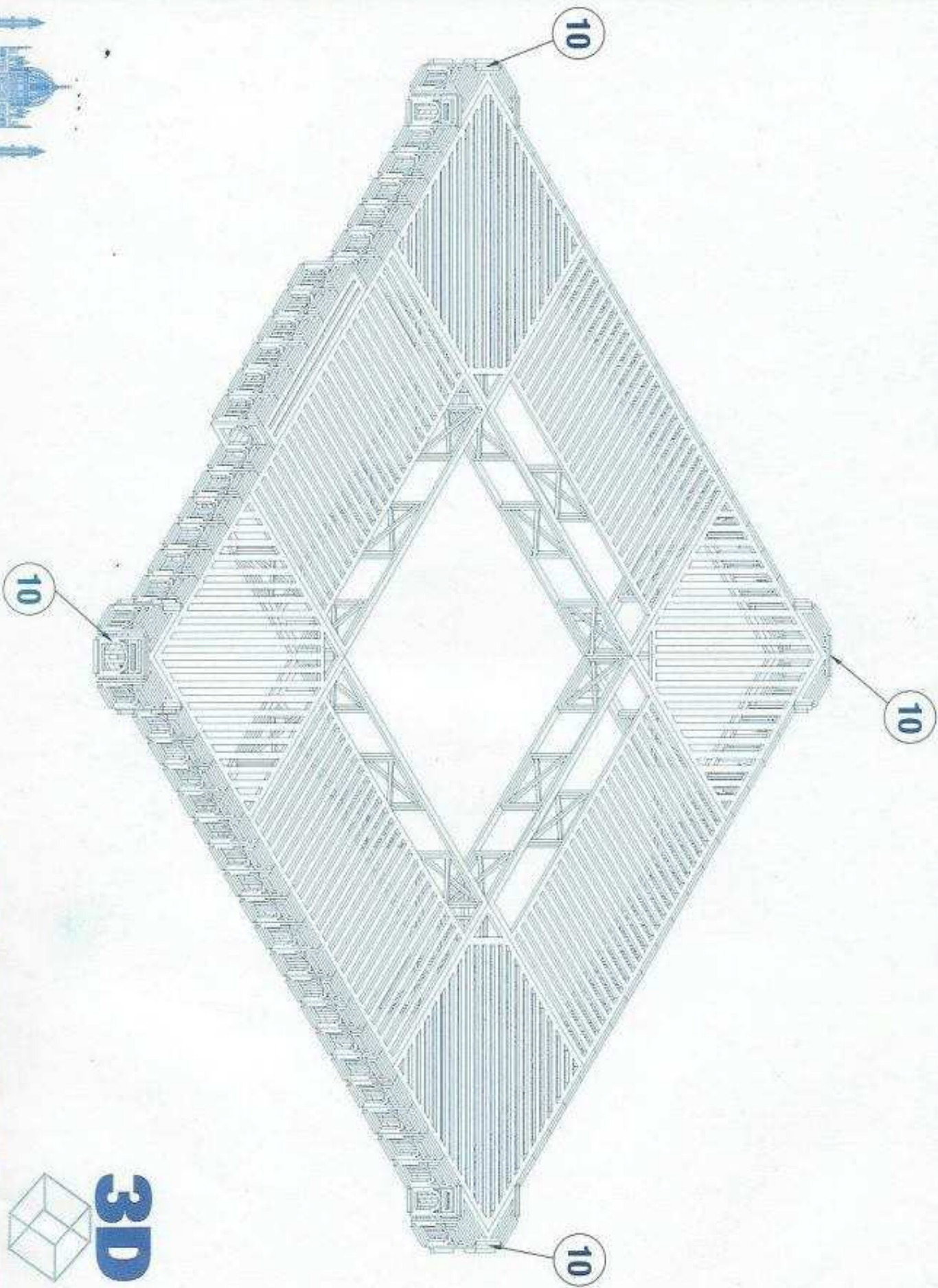

© 2004 Elsevier Inc.

10

10

10

10

4x11

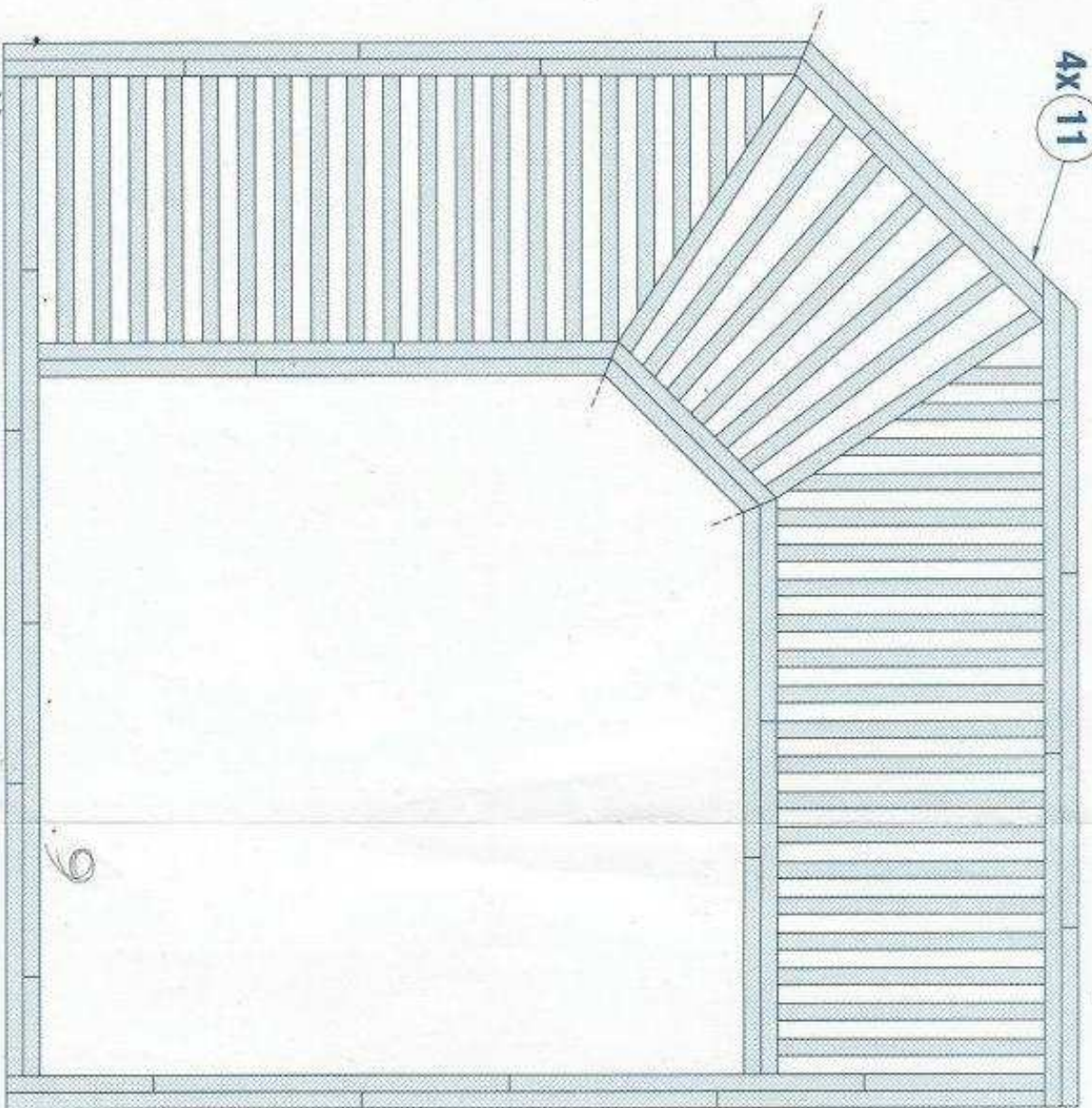

12x12

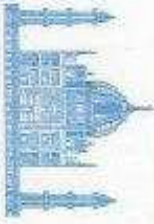
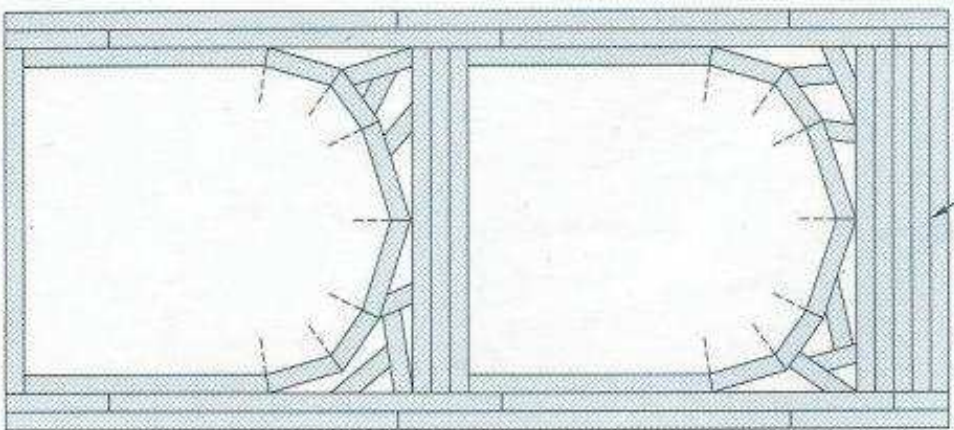

© 2004 Blyskal, Inc.

MATCHITECTURE

17 / 53

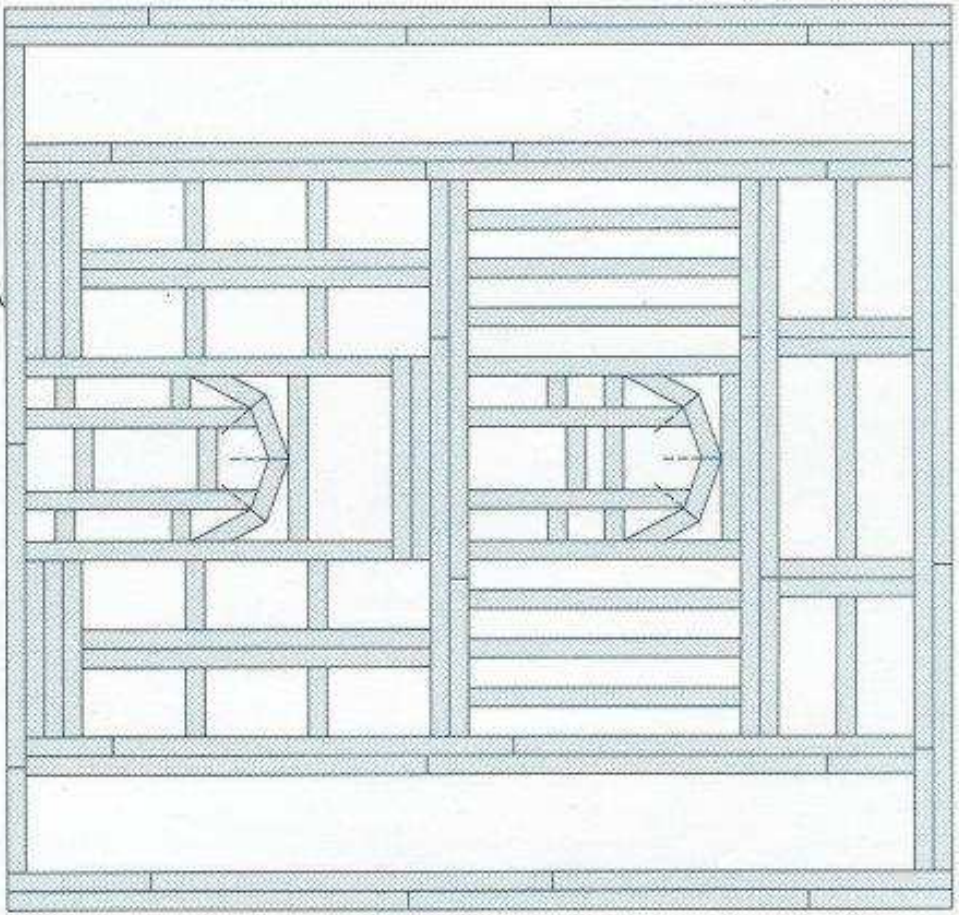

4x13

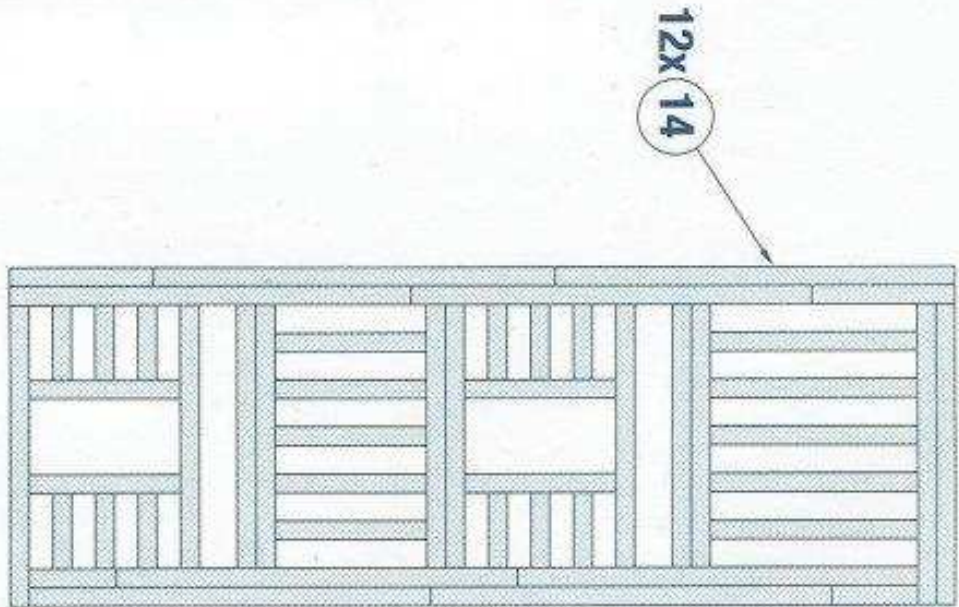

12x14

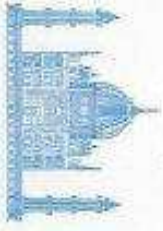

© 2004 Bayside Inc.

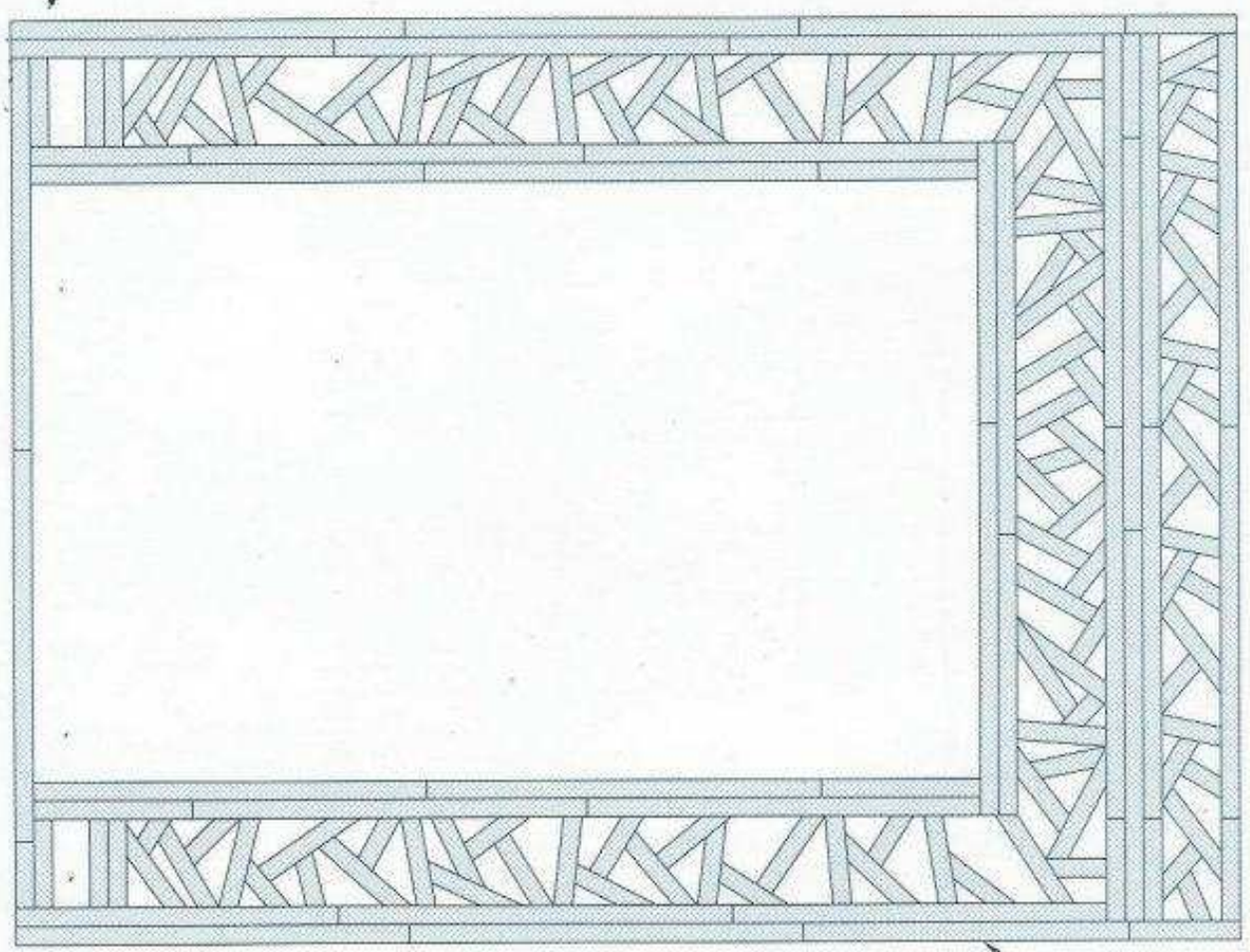

4x 15

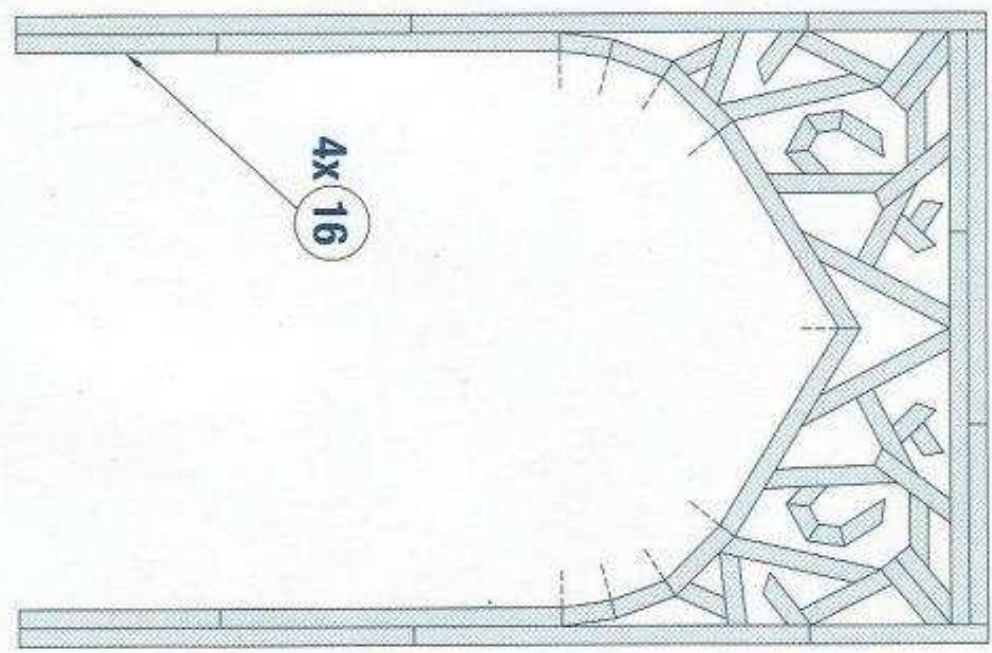

4x 16

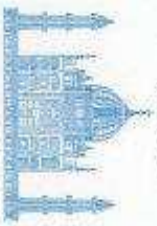
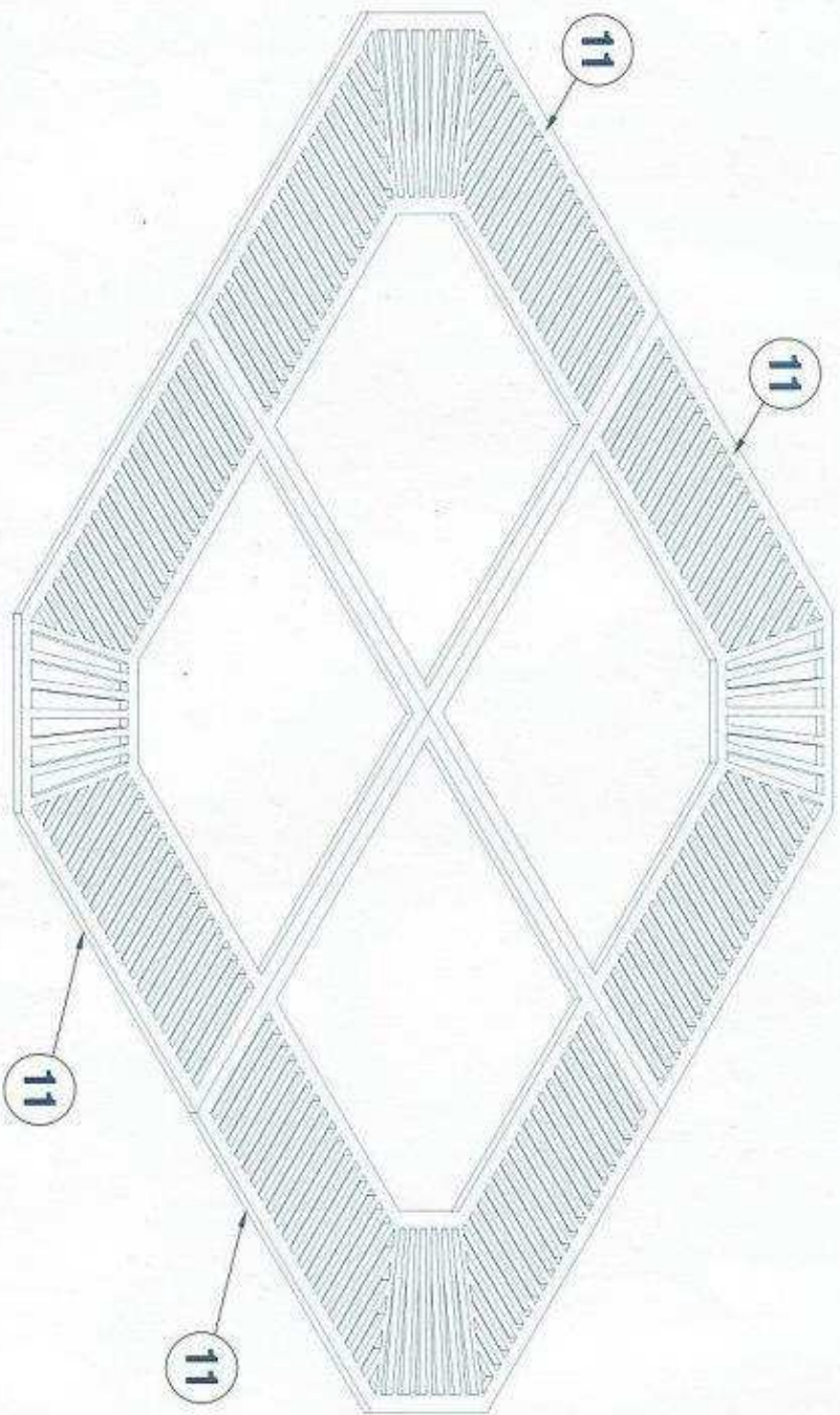

© 2004 Baylan Inc.

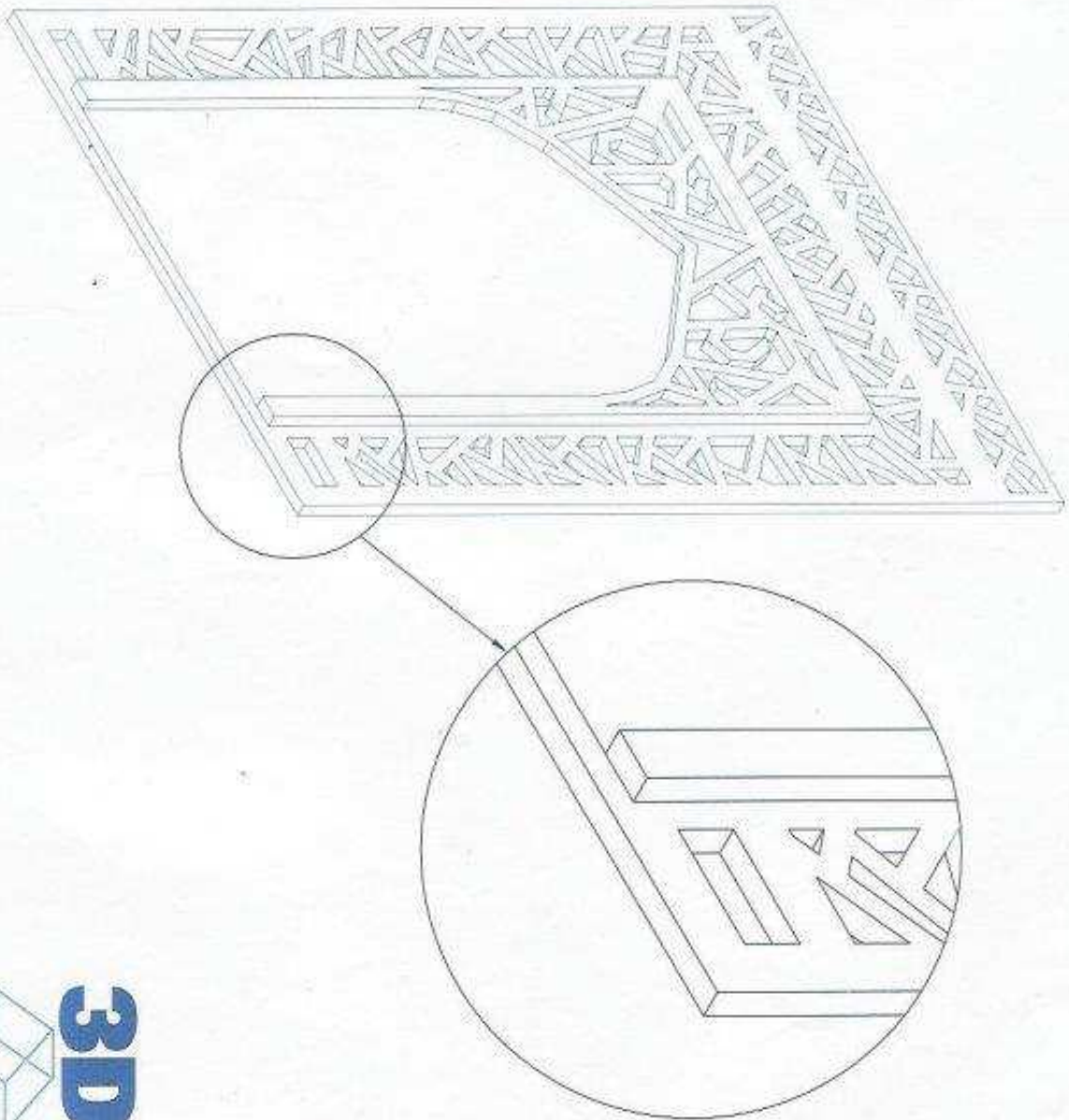
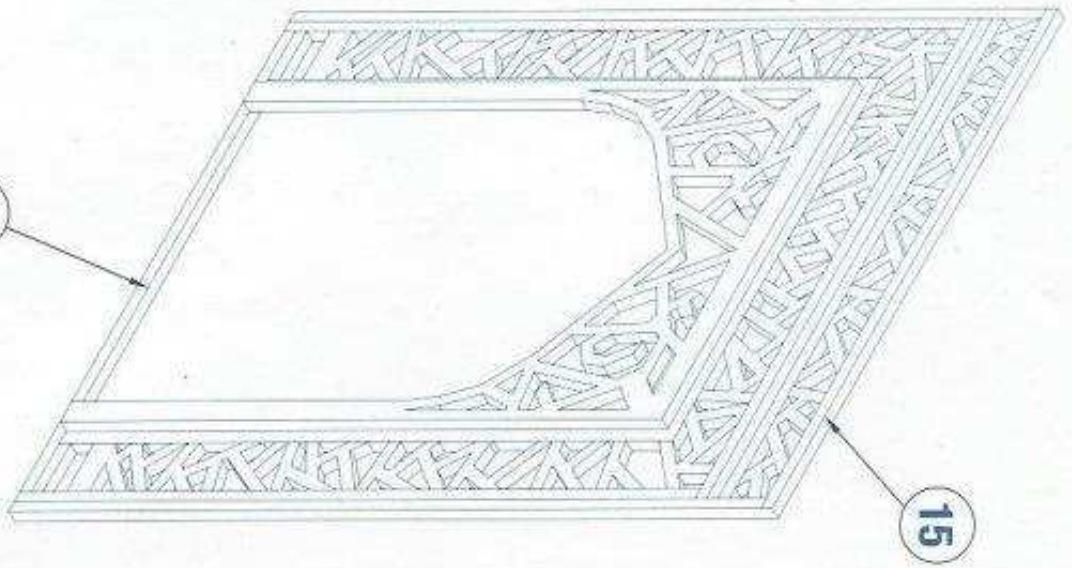

© 2004 Bayview Inc.



© 2004 Deyuan Inc.

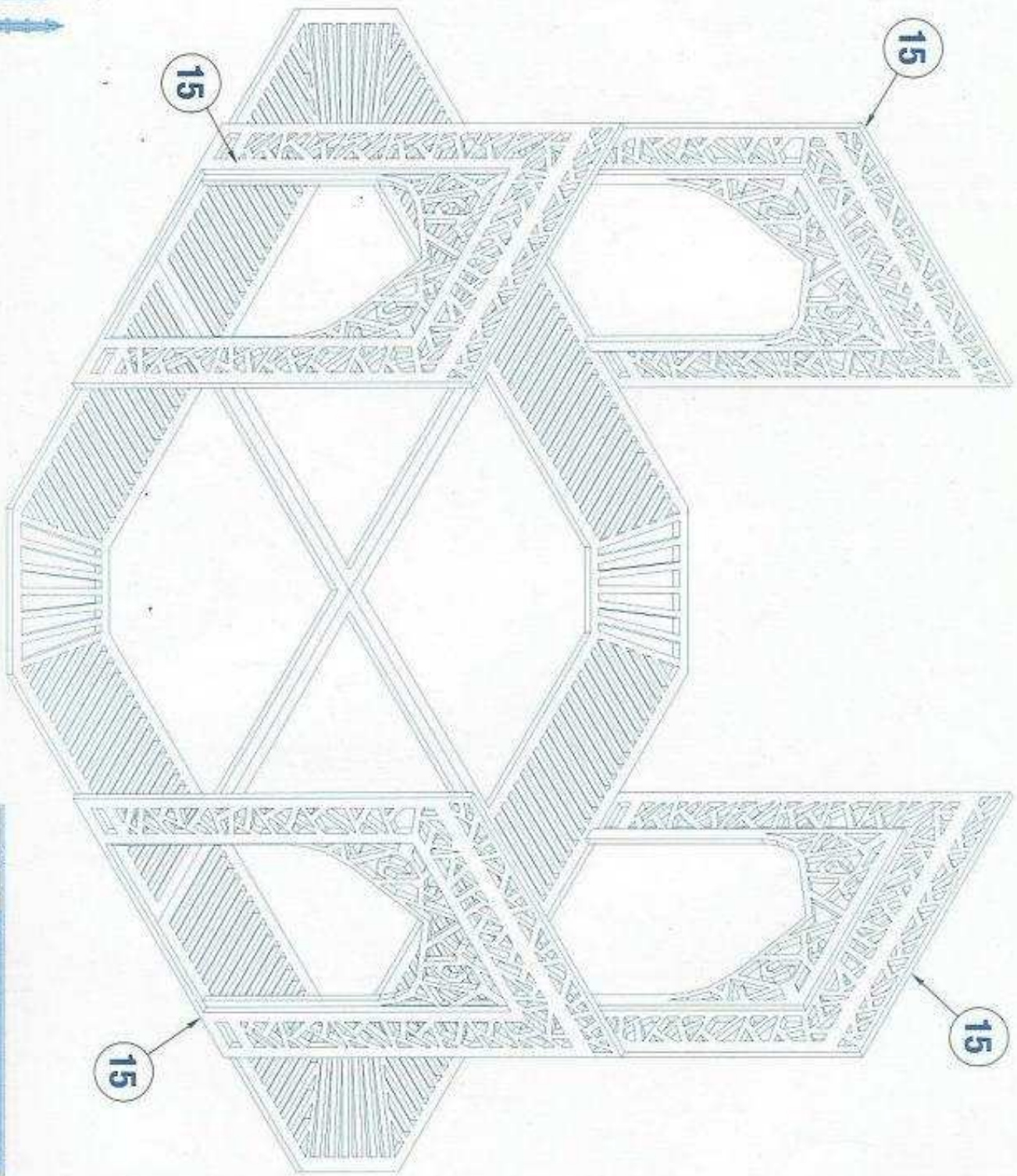

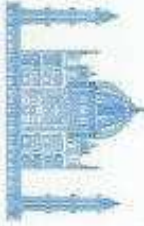
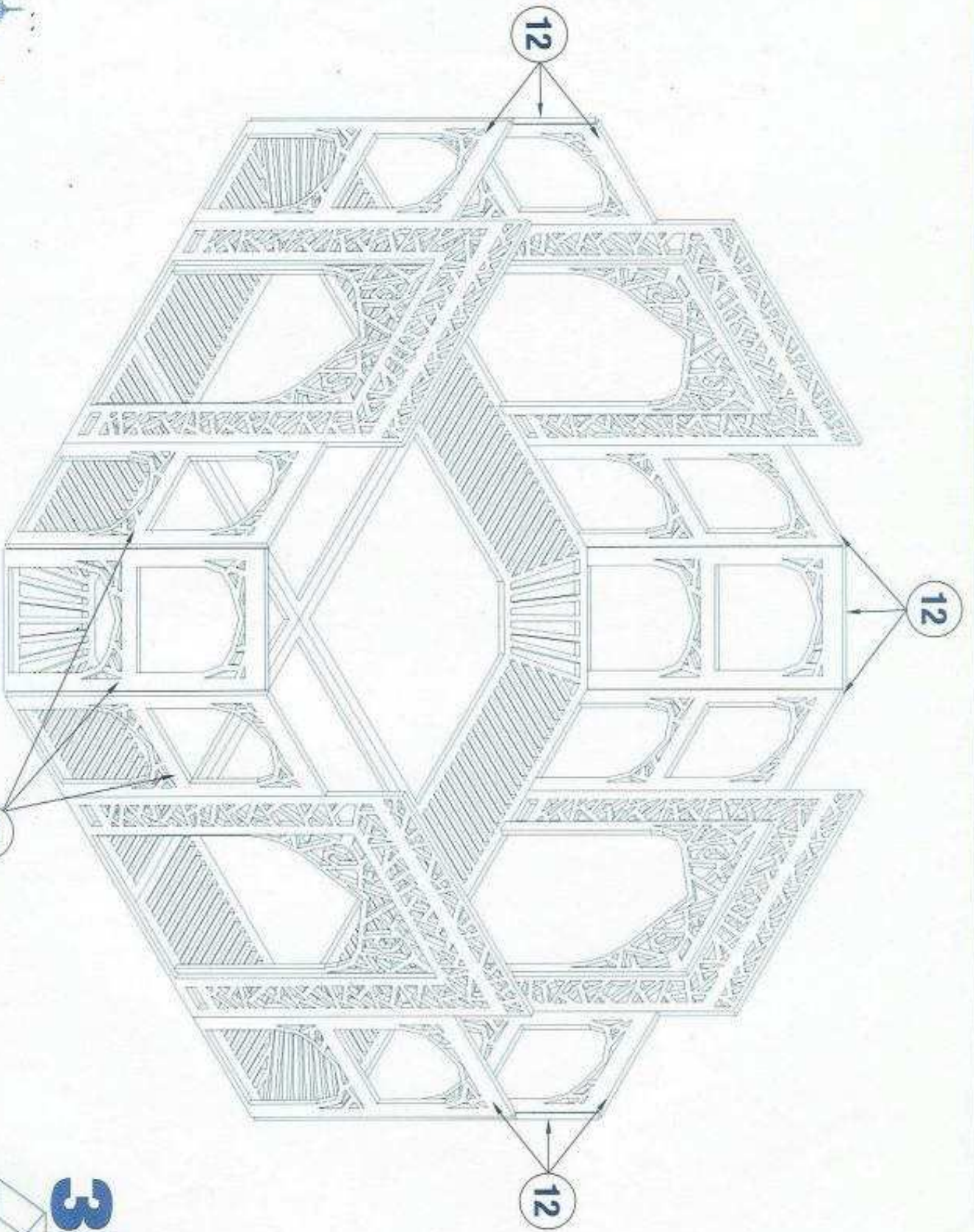

© 2004 Bayart Inc.

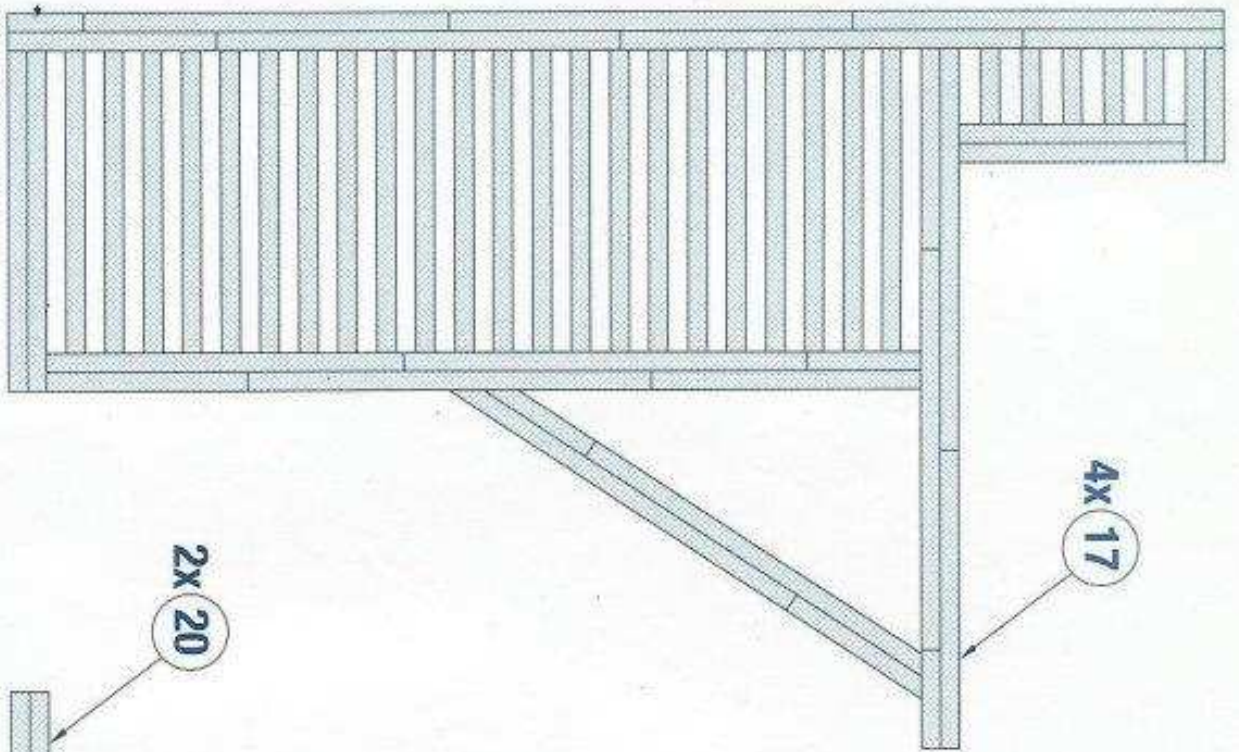

4x 17



4x 18



4x 19



2x 20



© 2004 Ekena Inc.

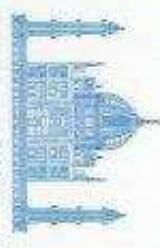
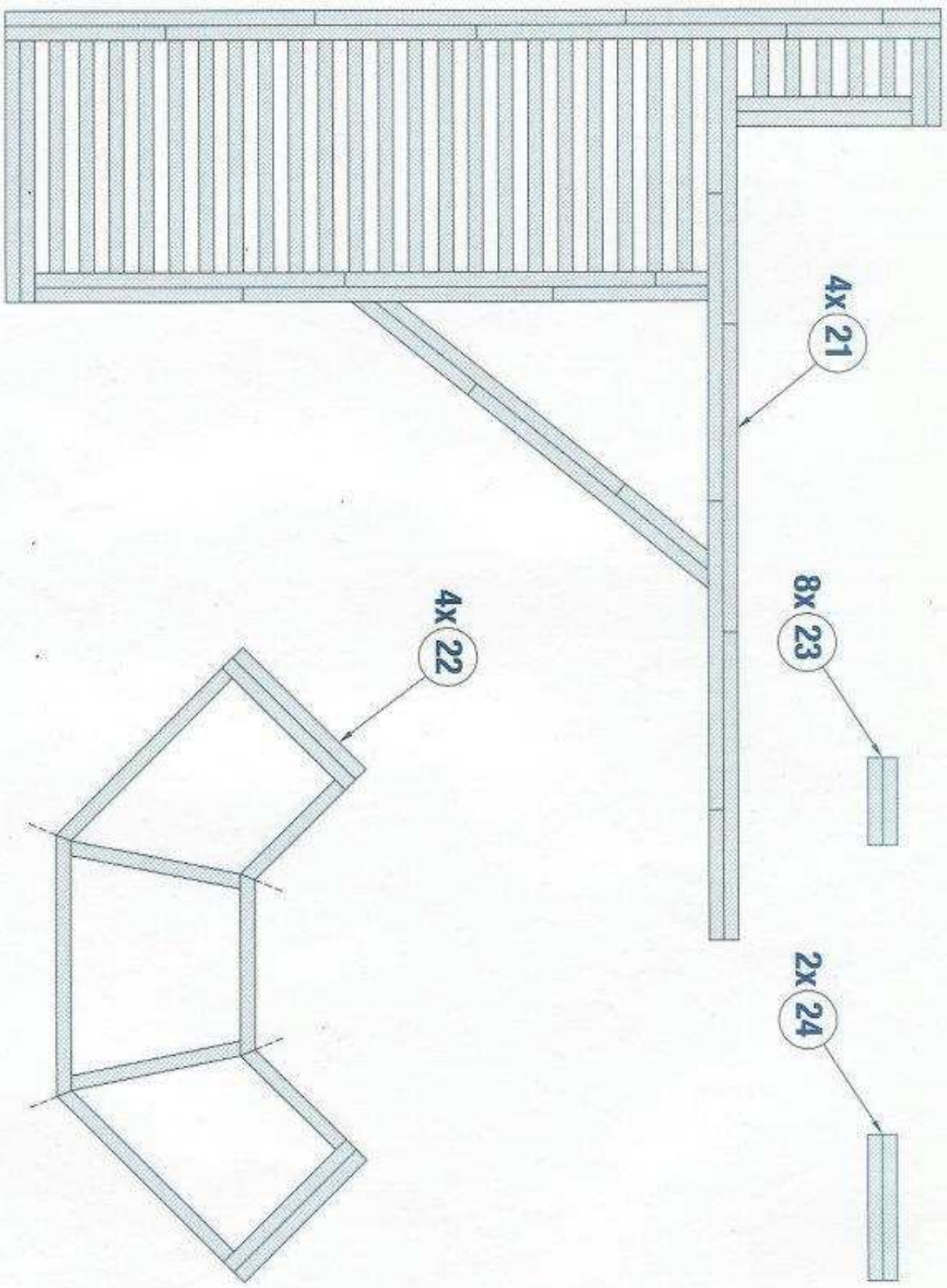

© 2004 Bayview Press

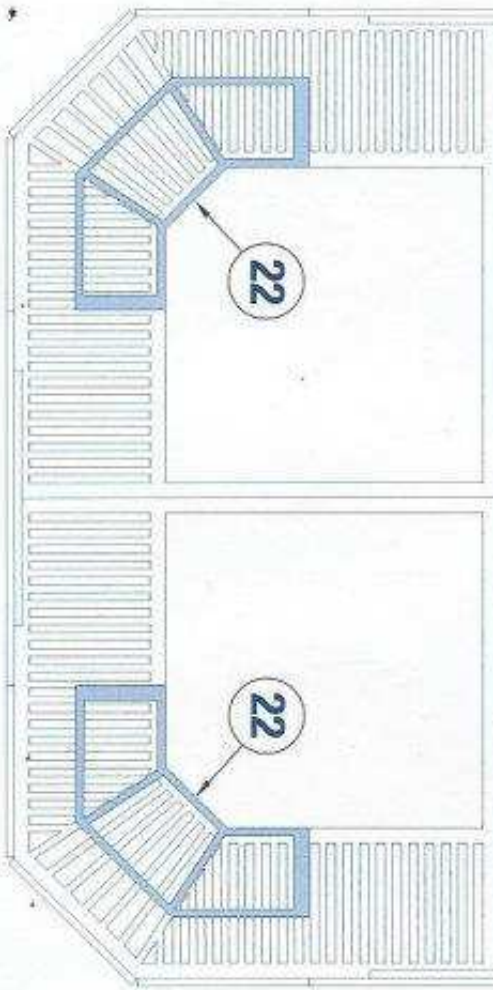
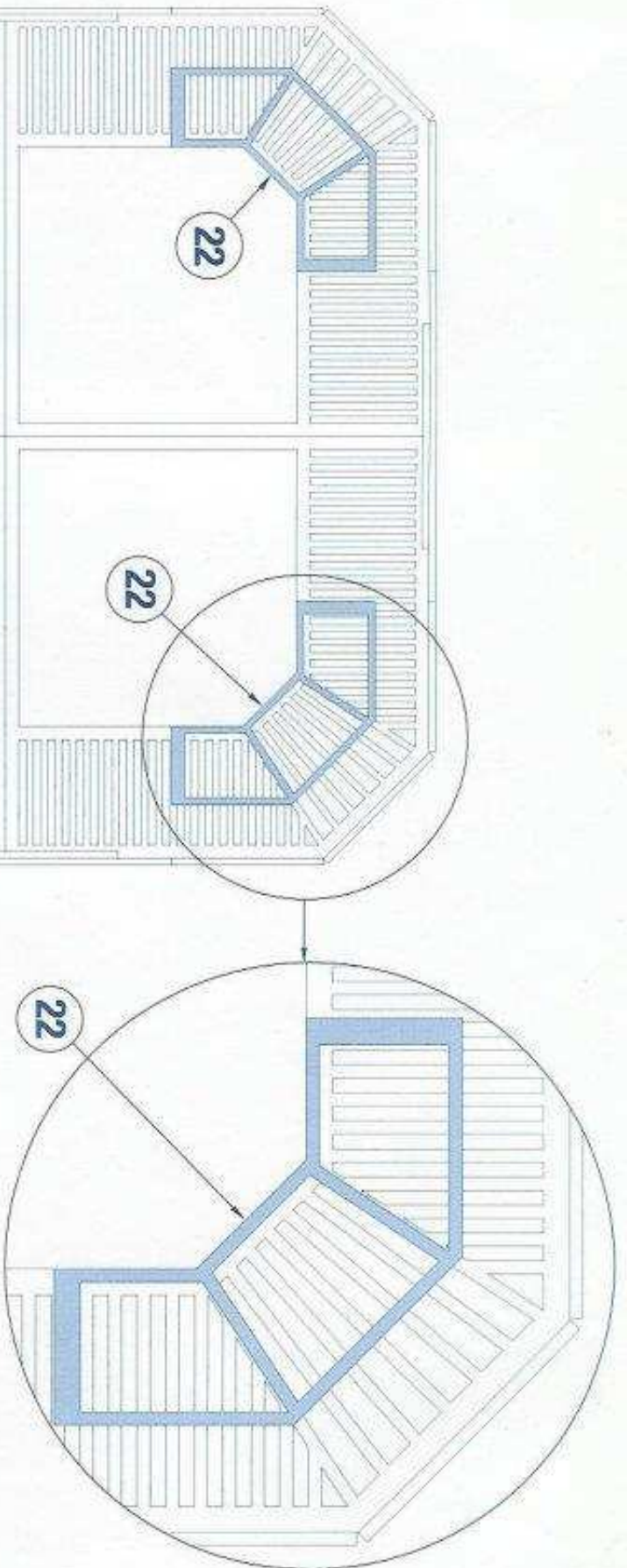

3D

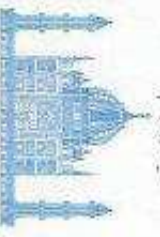

© 2004 Aspen Inc.

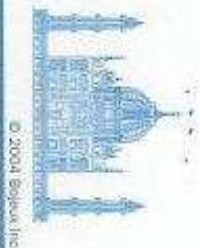
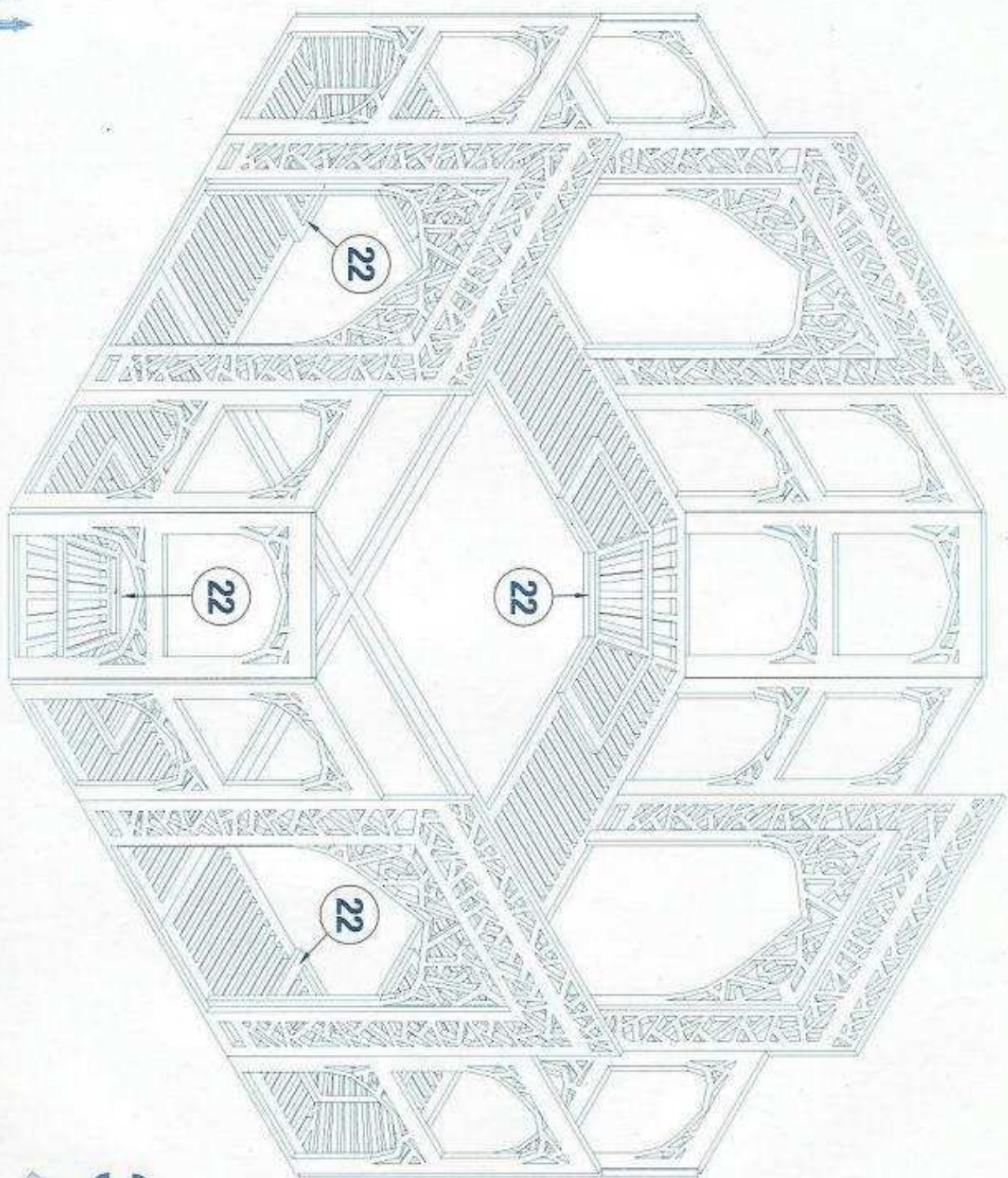

© 2004 Savaia, Inc.

3D

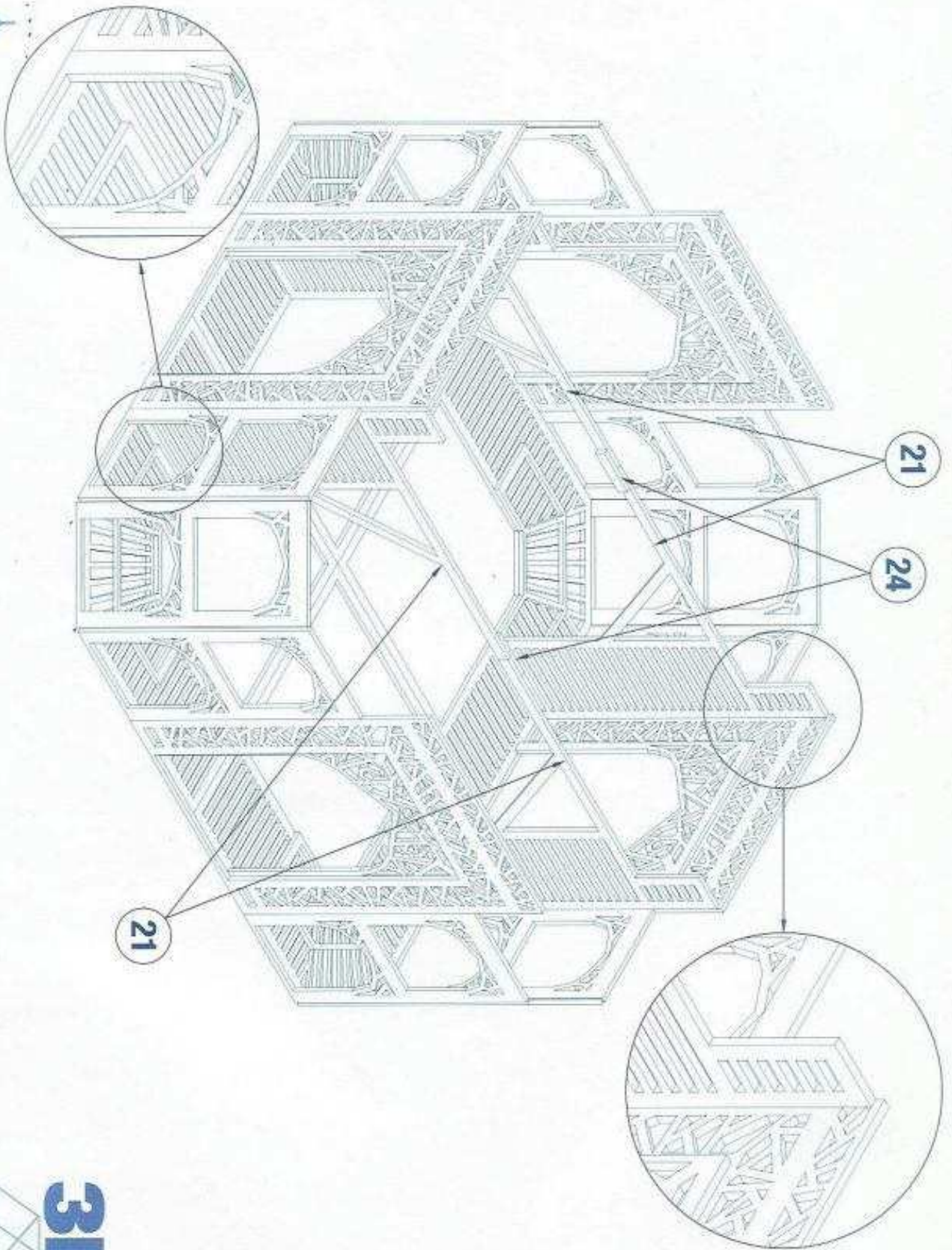

© 2004 Omega, Inc.

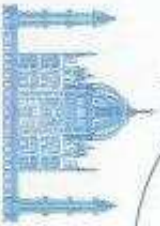

© 2014 Bogen, Inc.

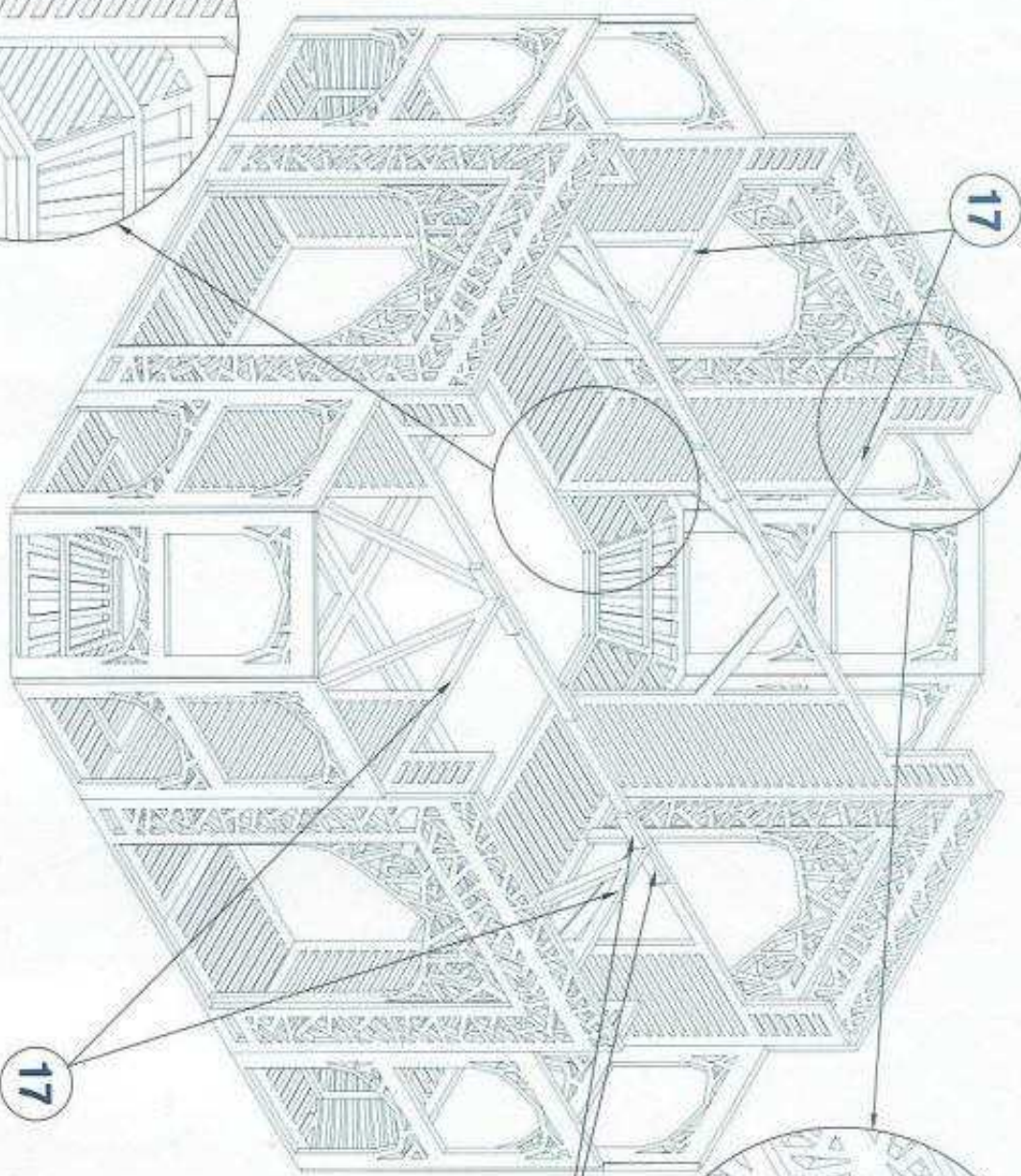
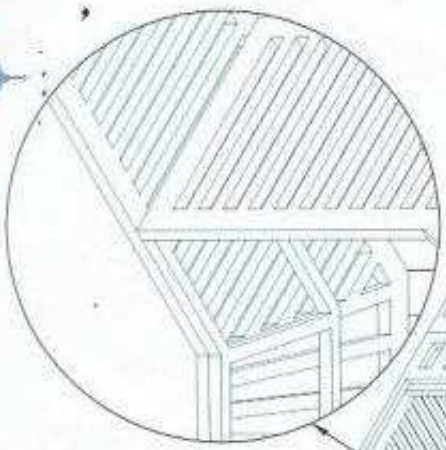

17

17

23



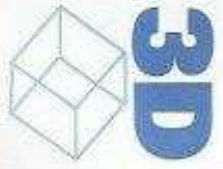
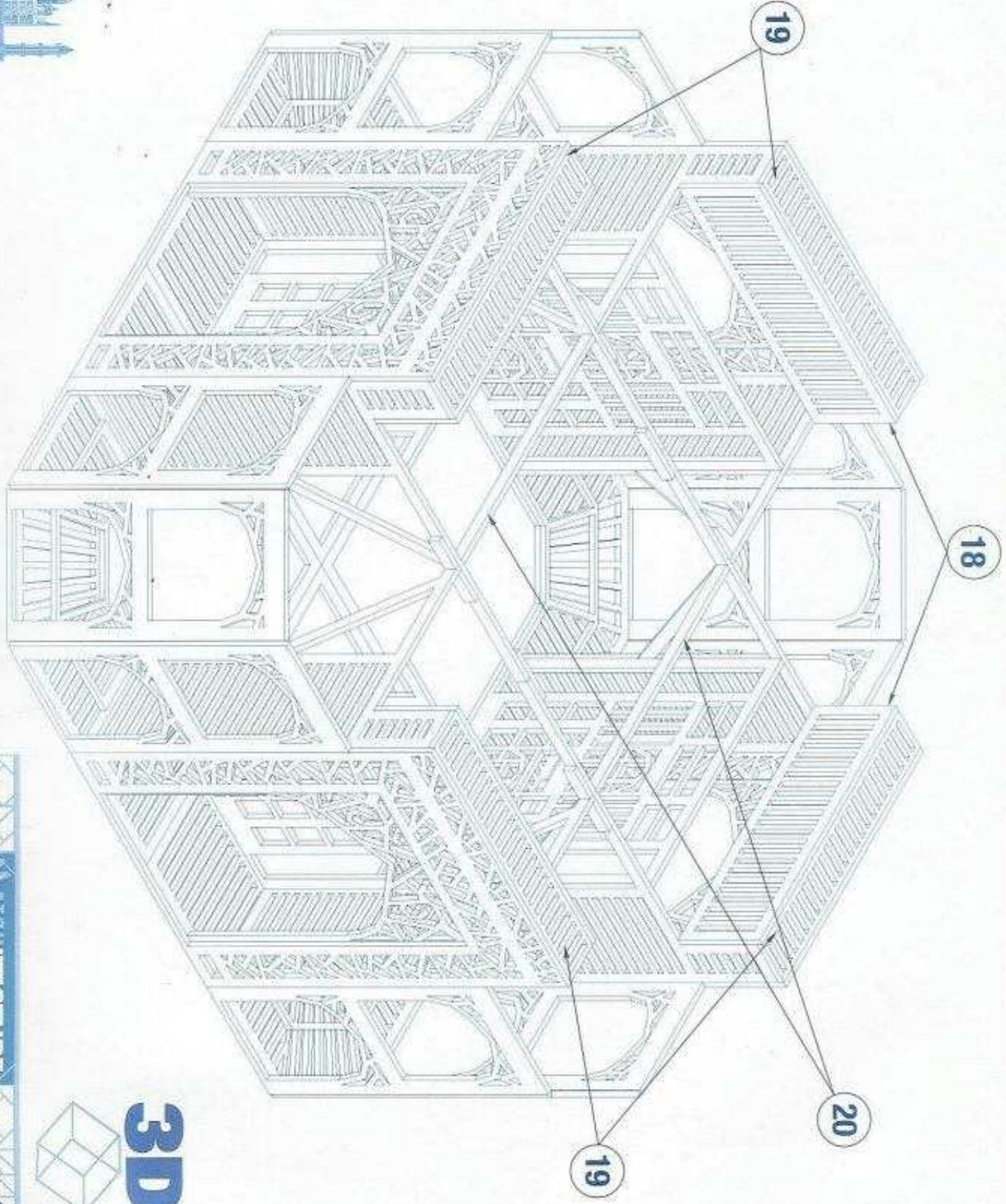
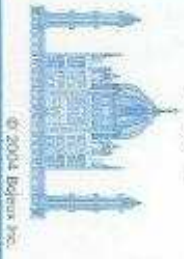

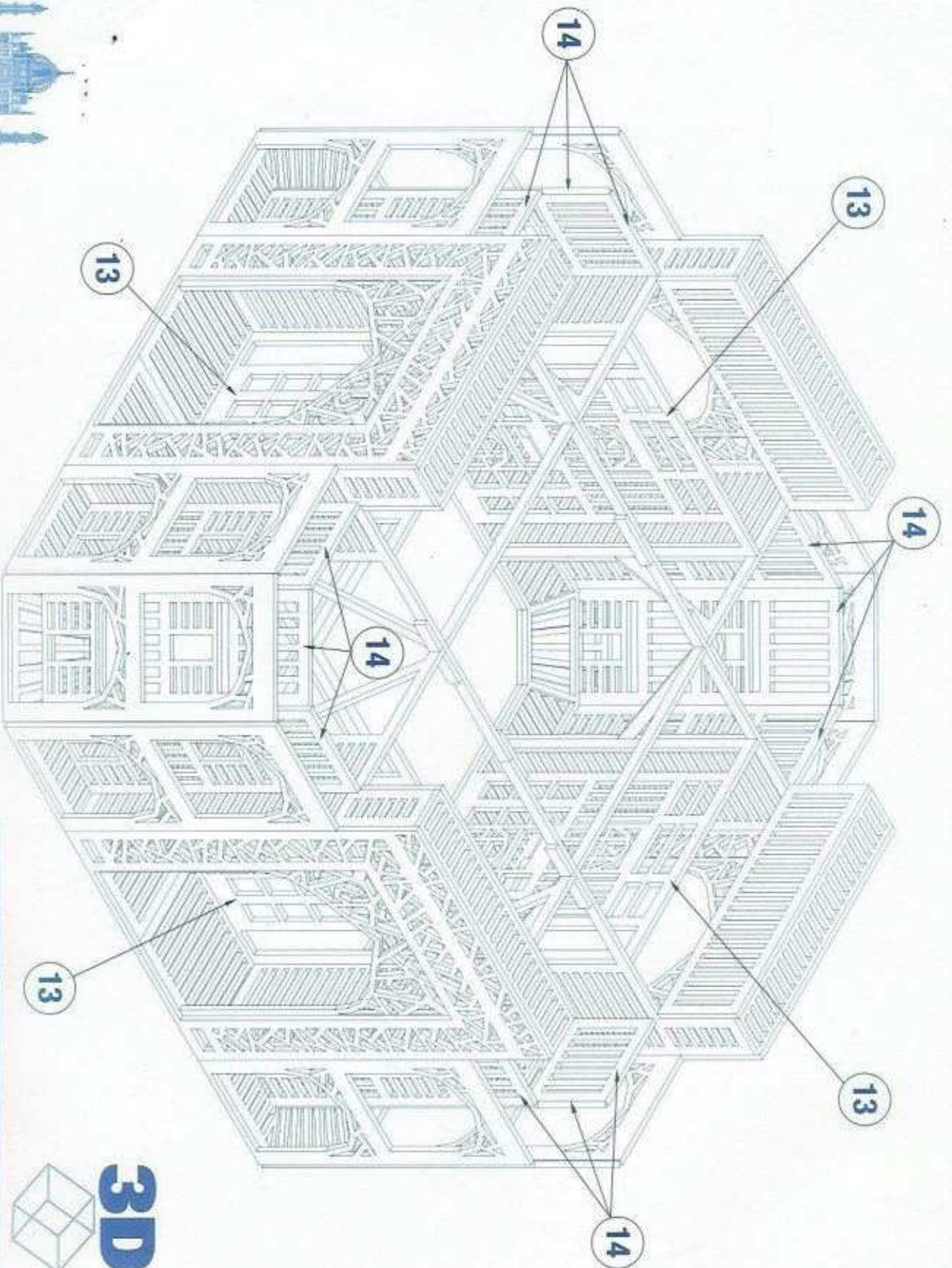

© 2004 Bepko Inc.



3D

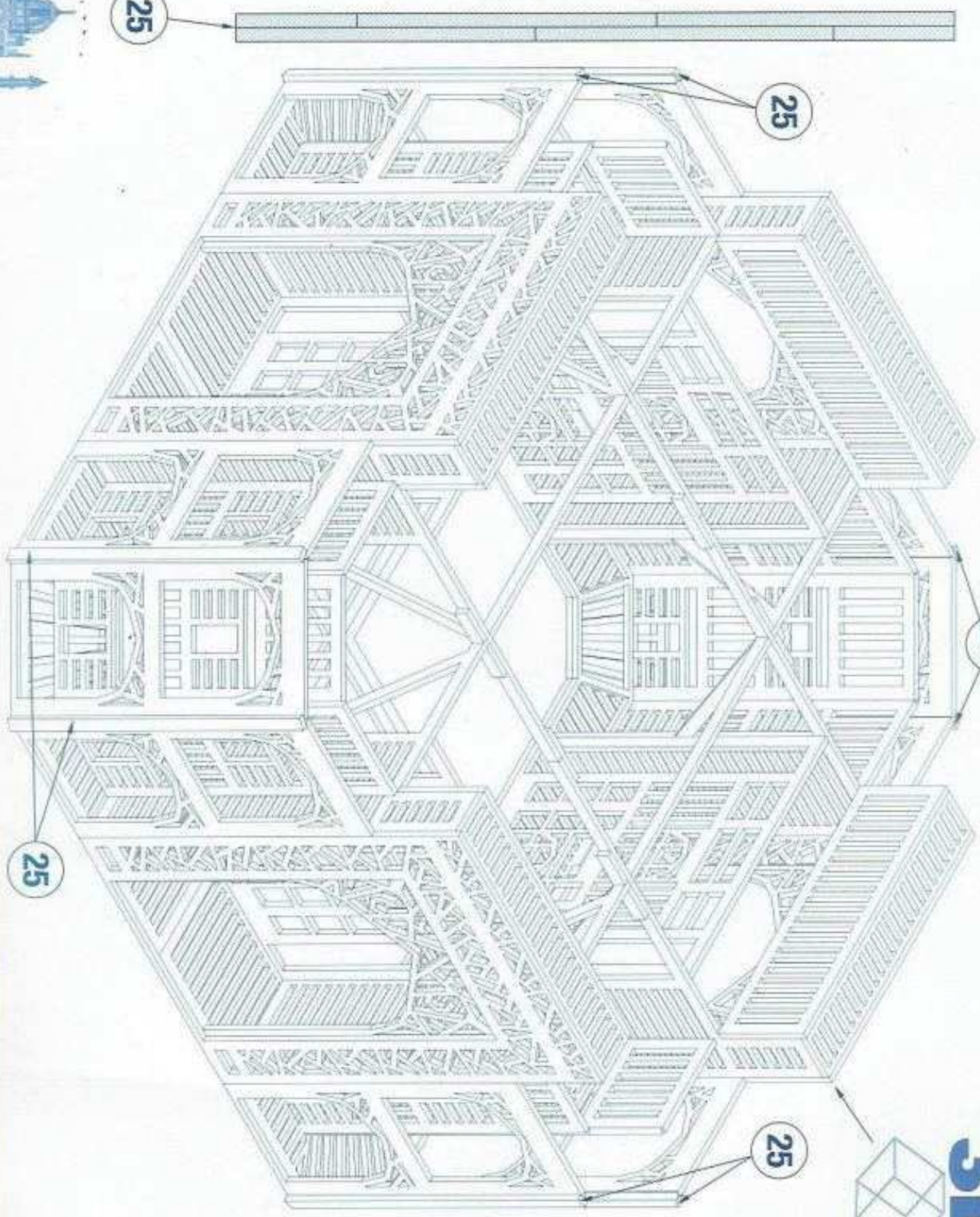

8x
25



© 2004 Ravens, Inc.

ARCHITECTURE

32
/53

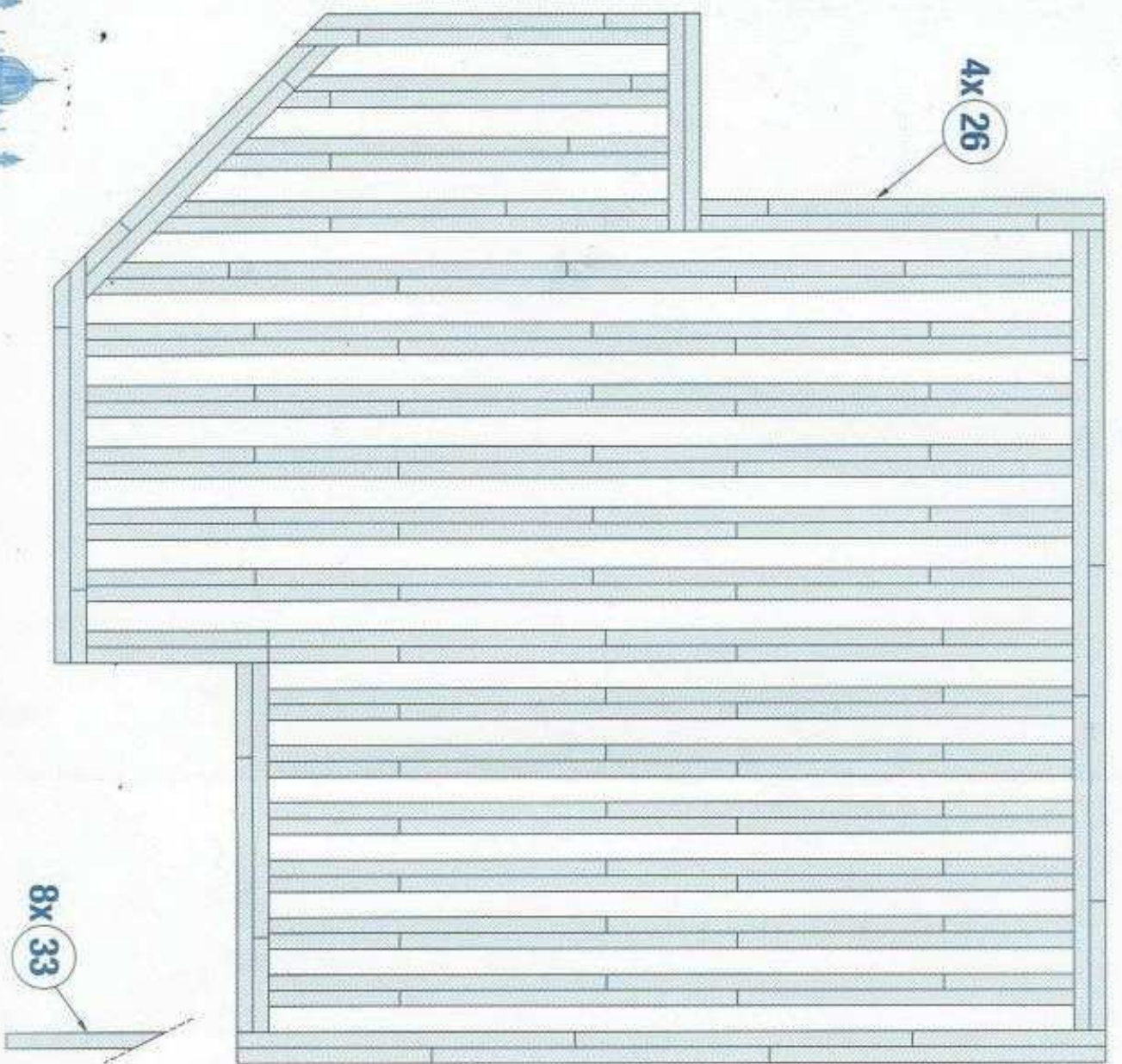

© 2004 Balaam, Inc.

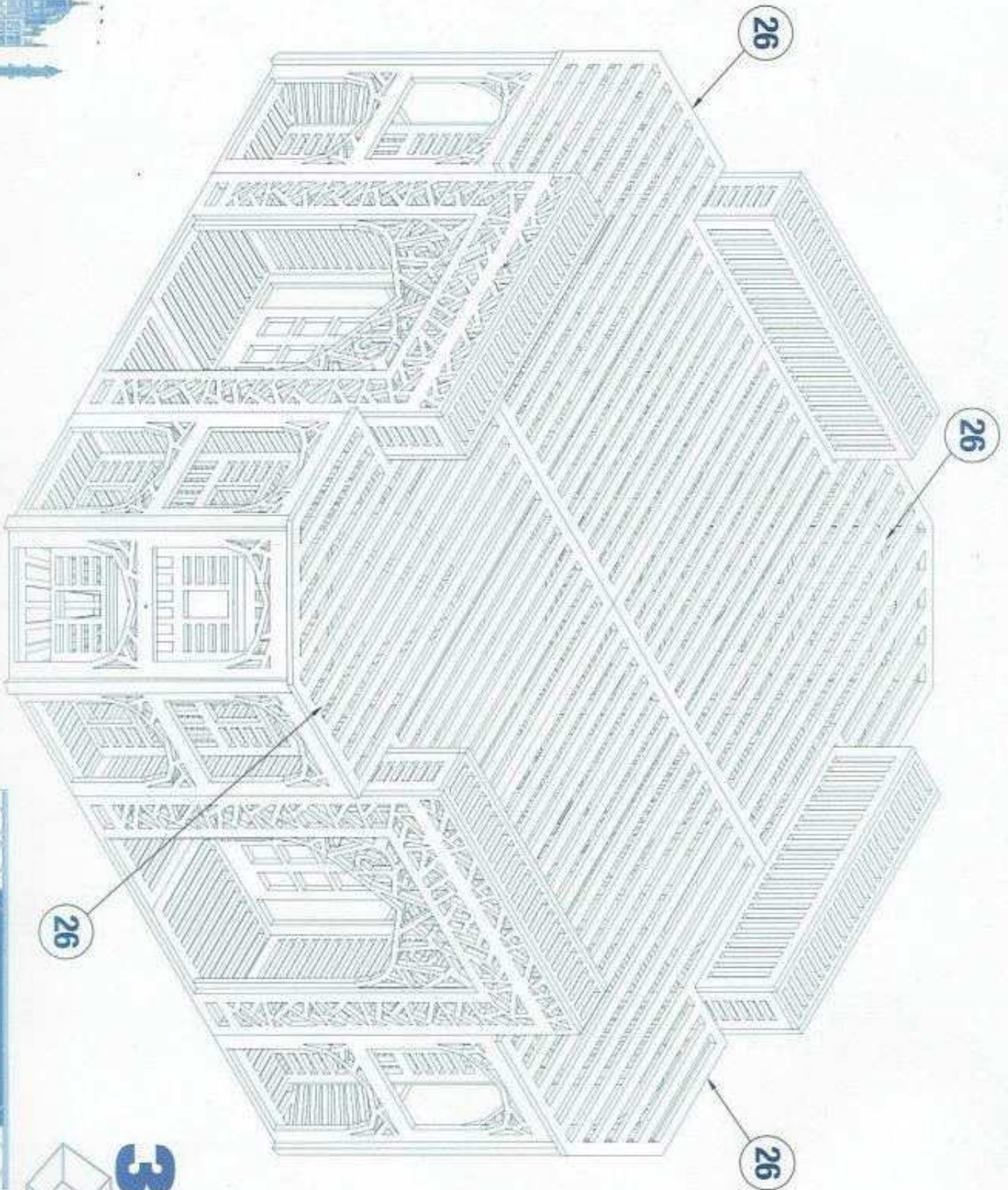

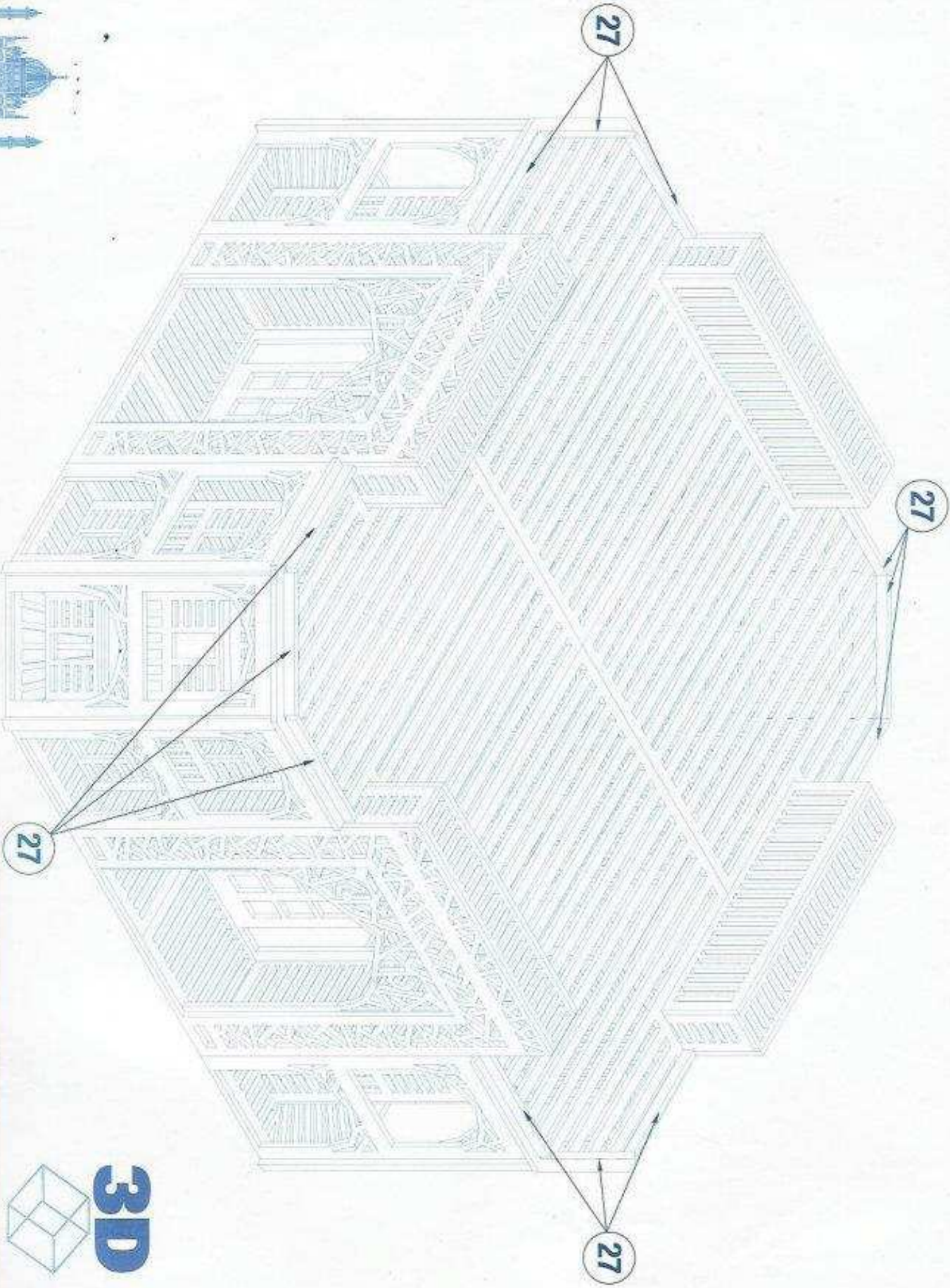

© 2004 Bayoux Inc.



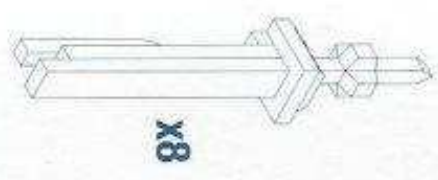
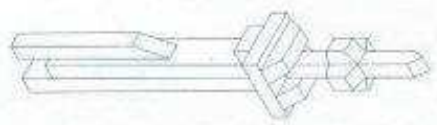
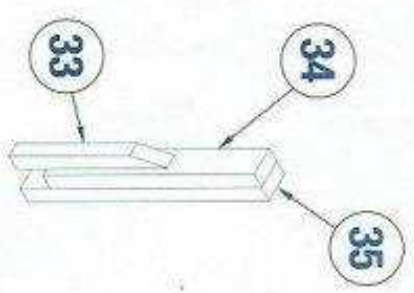
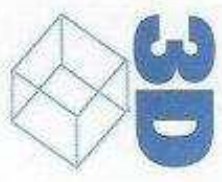
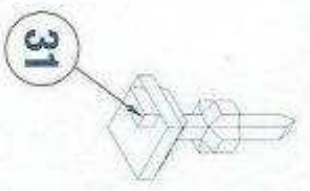
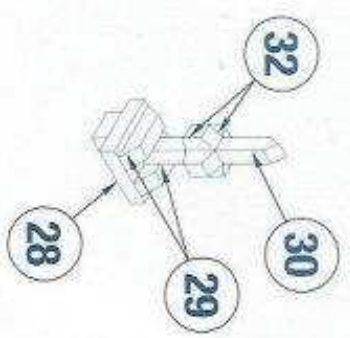

x8

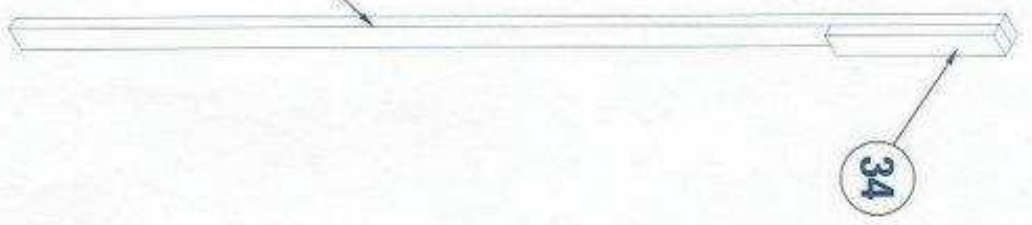

34



x8



8x 36

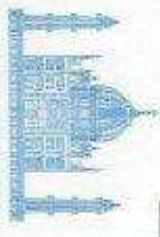

© 2004 Stewart, Inc.

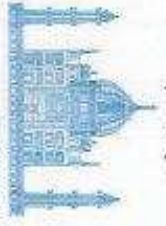

© 2004, Matchitecture, Inc.

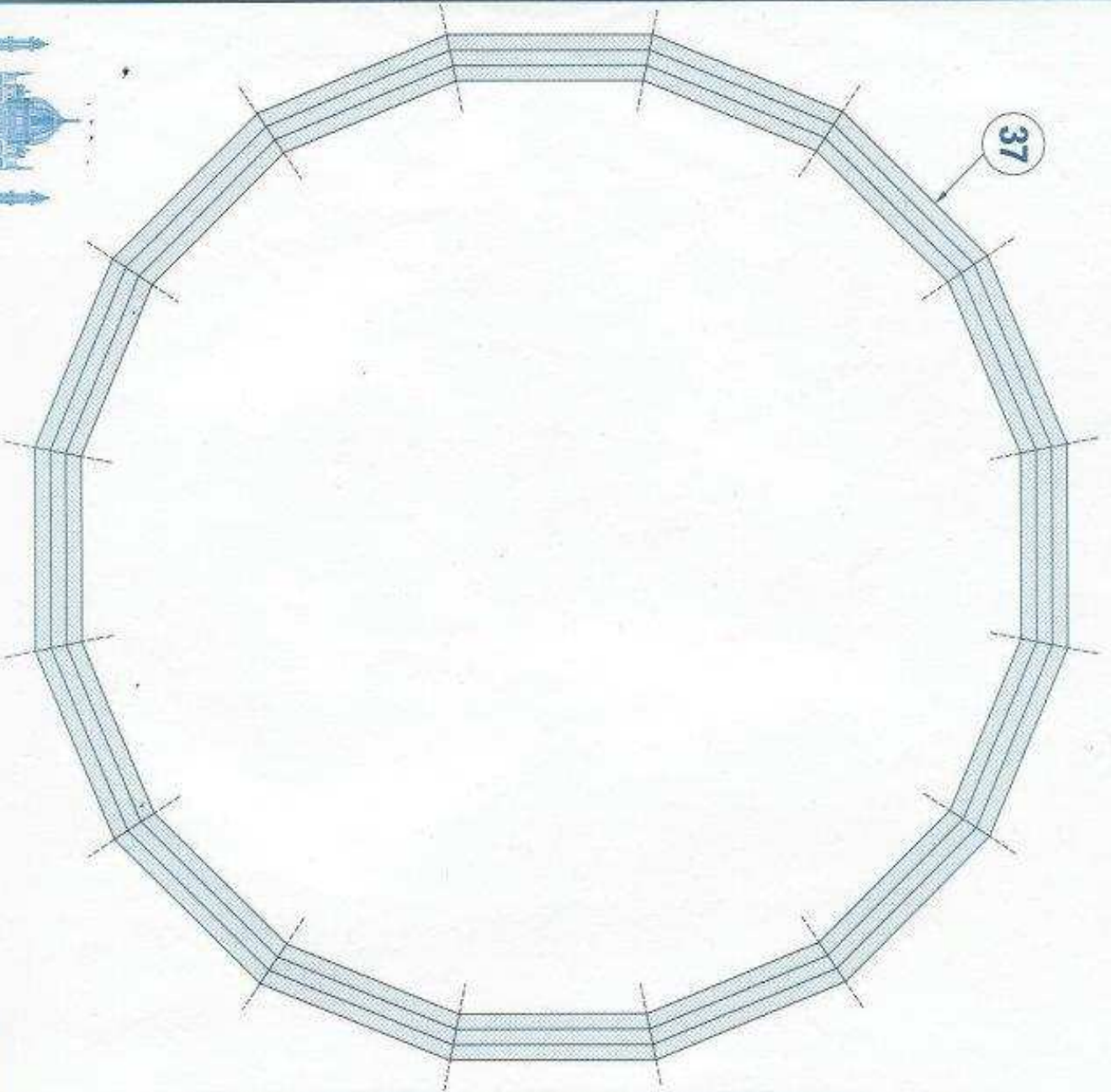

37

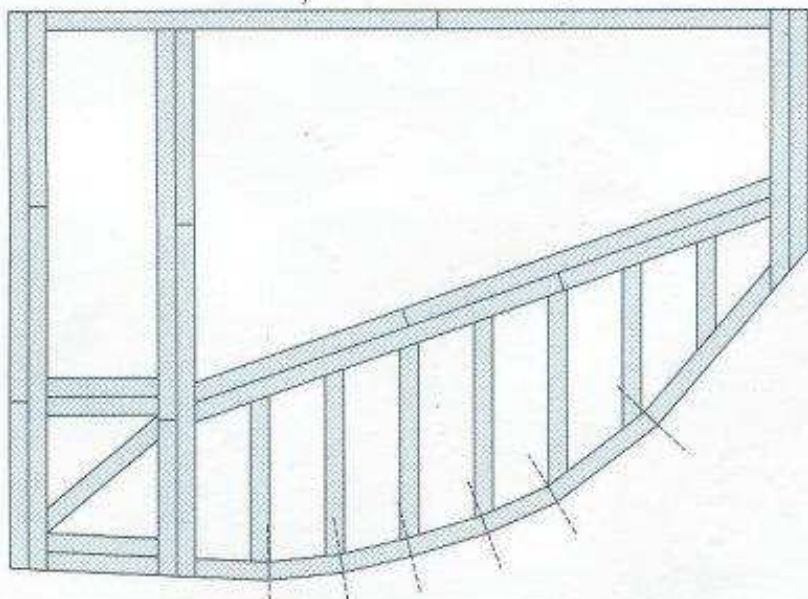

4x 38

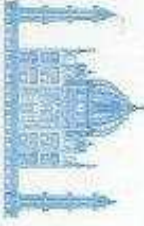

© 2004 Bejeux Inc.

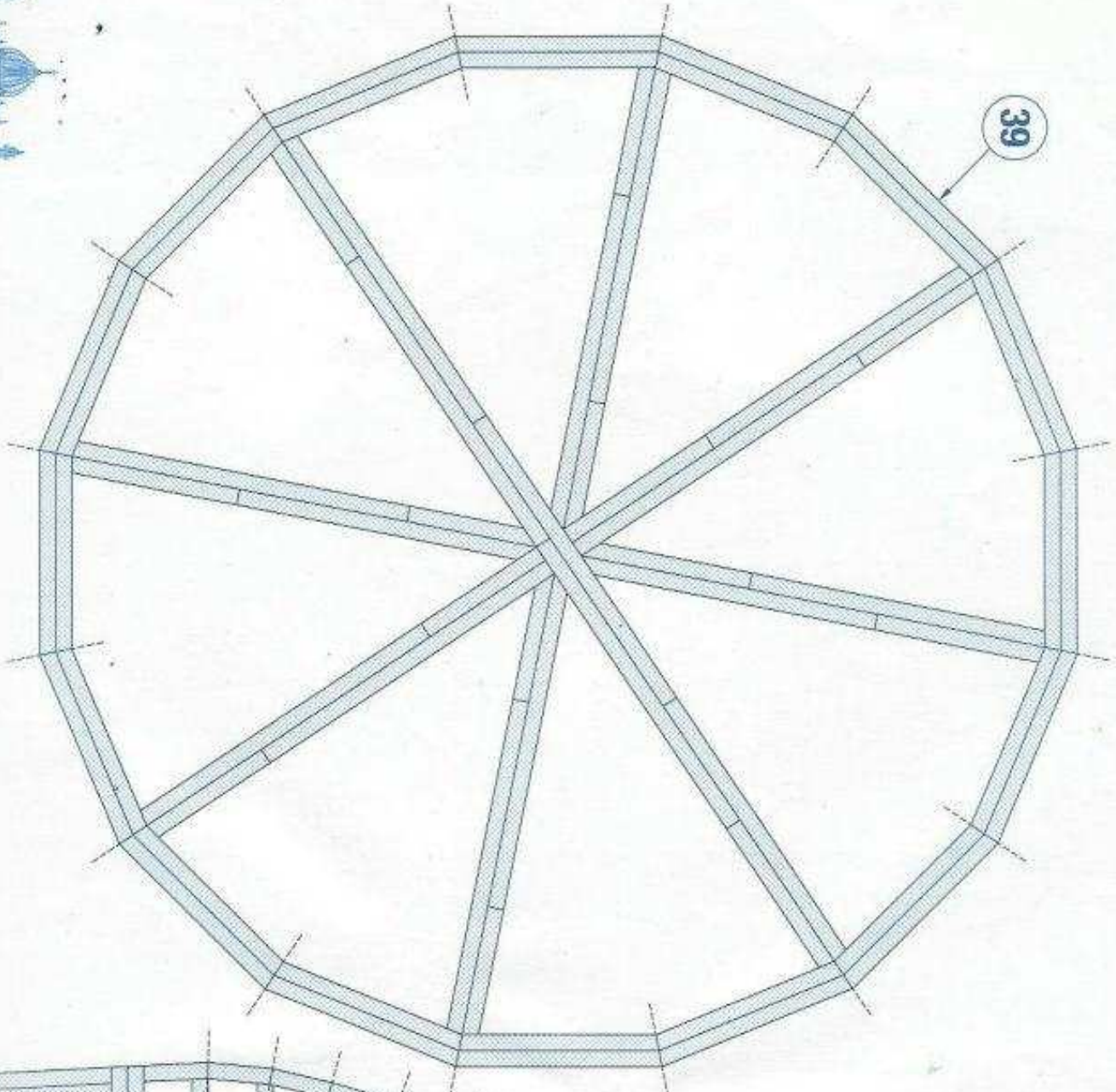

39

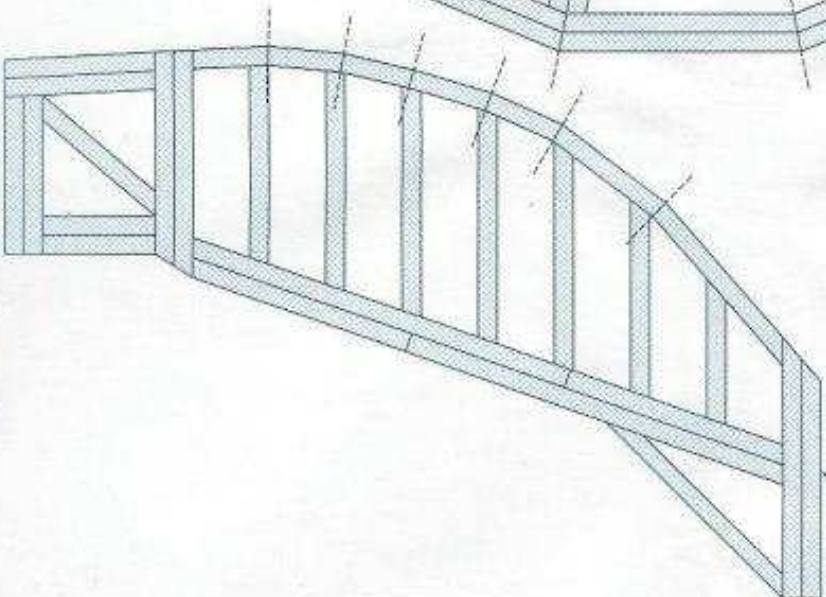

8x 41

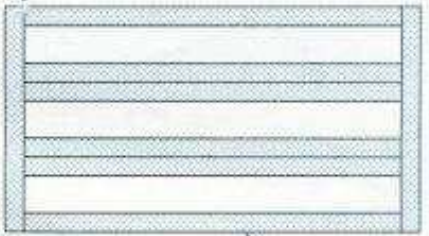

16x 40

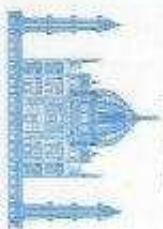
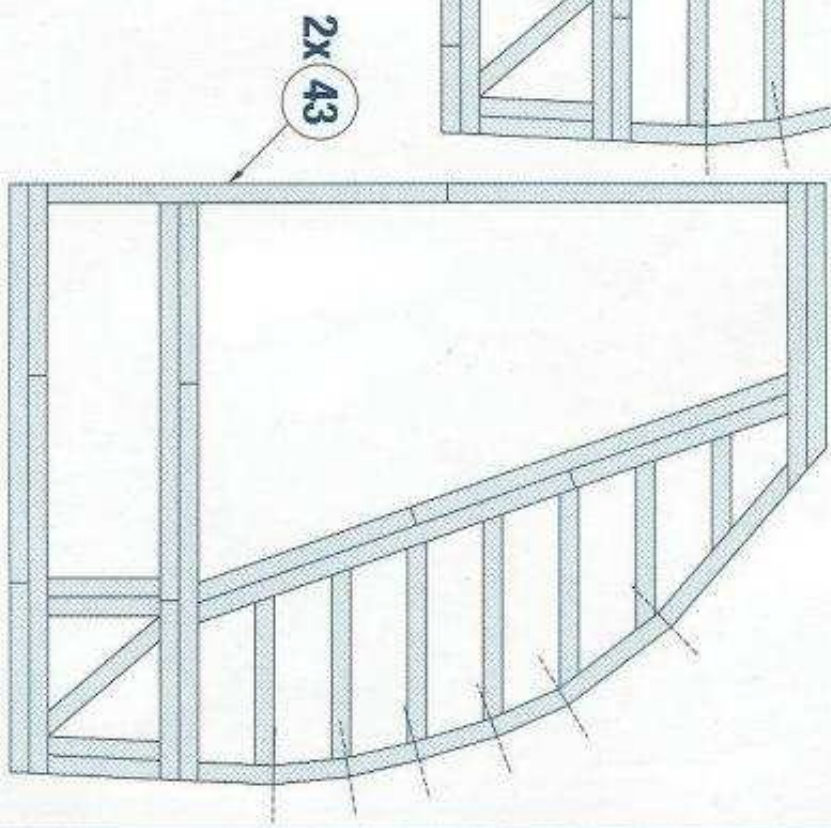
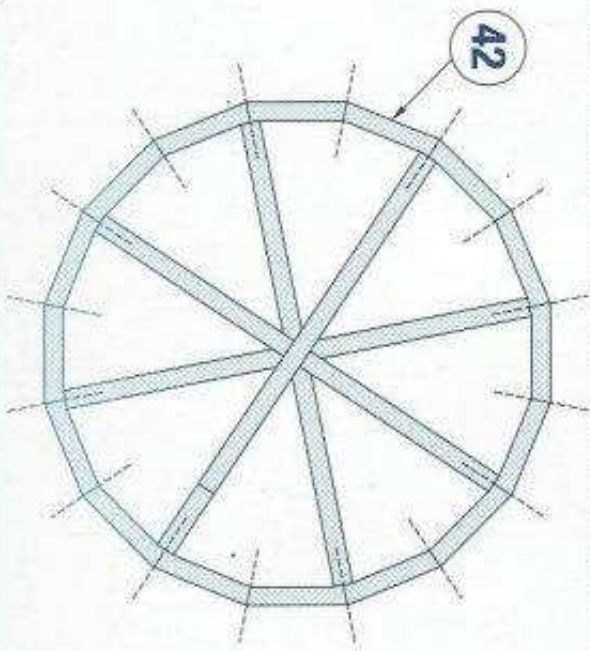
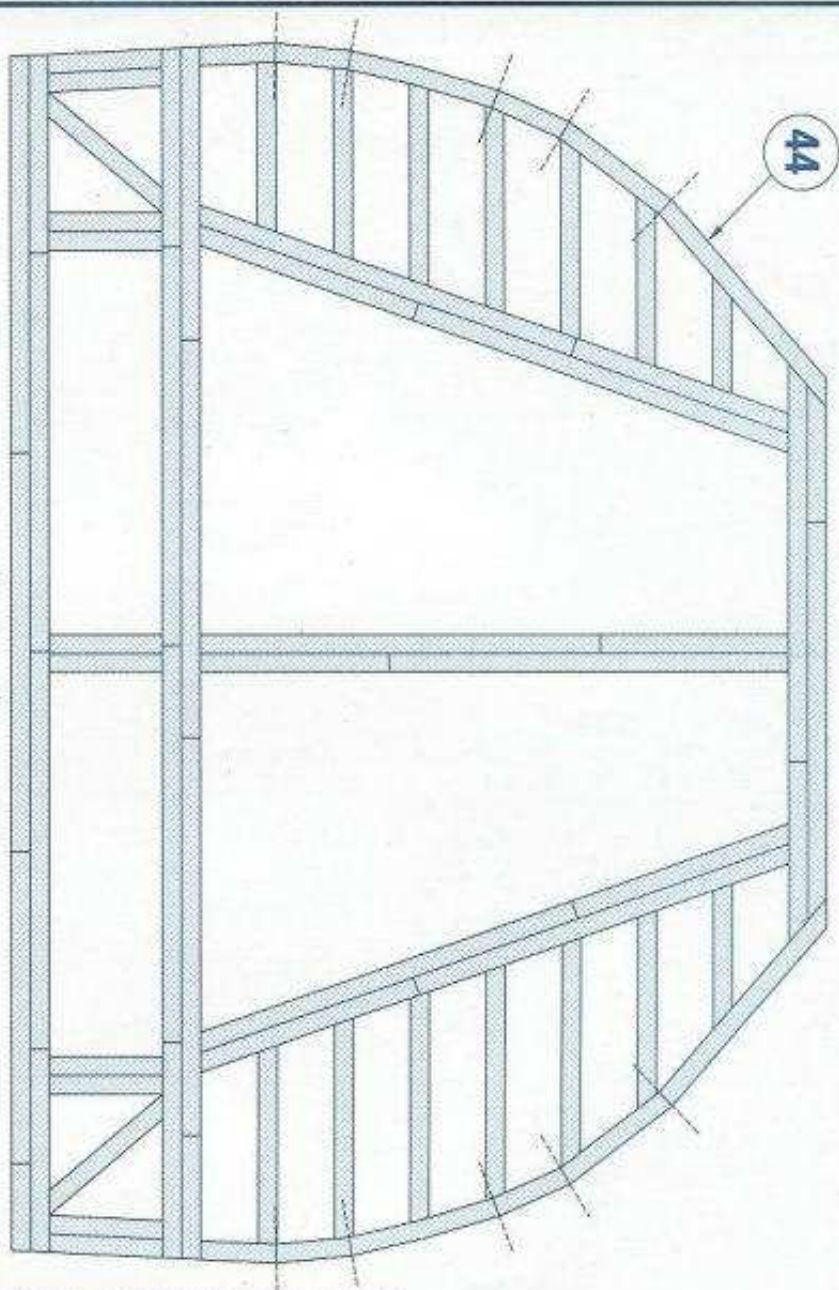

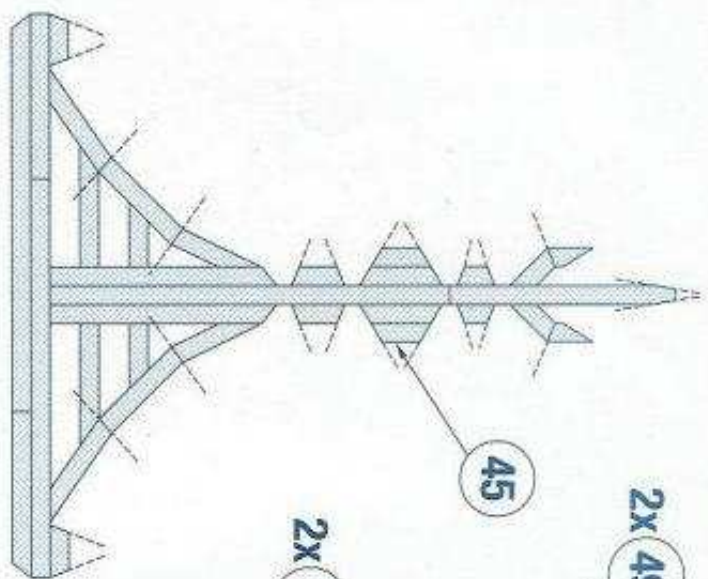

2x 49



2x 51



2x 50

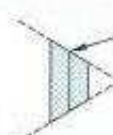

42

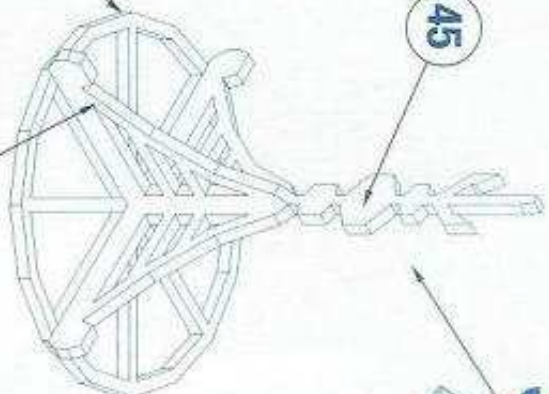

45

46

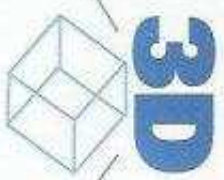

3D

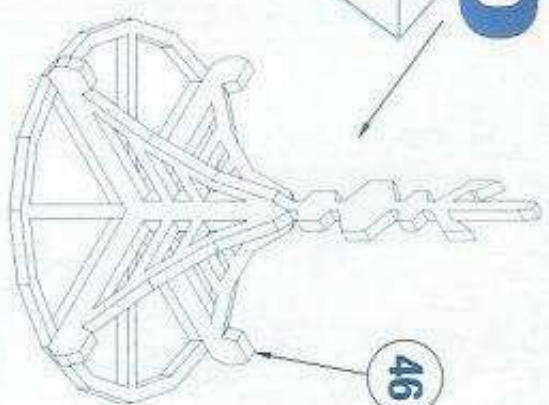

46

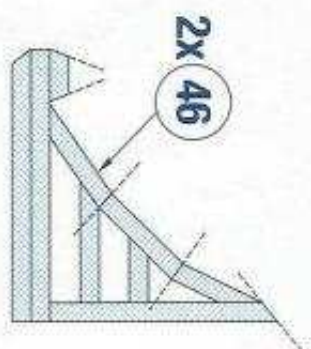

2x 46

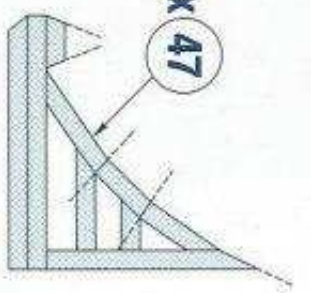

4x 47

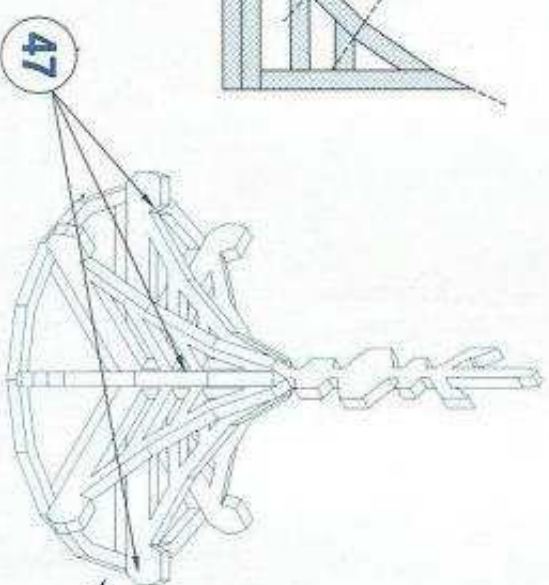

47

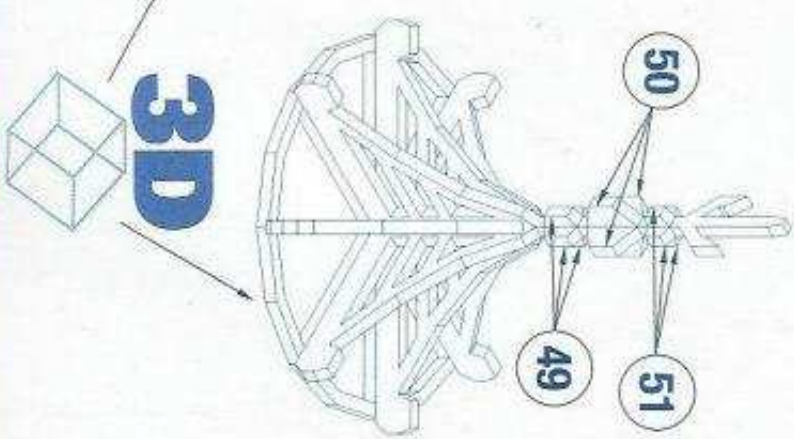

49

51

50



3D



16x 48



© 2004 Bopex, Inc.

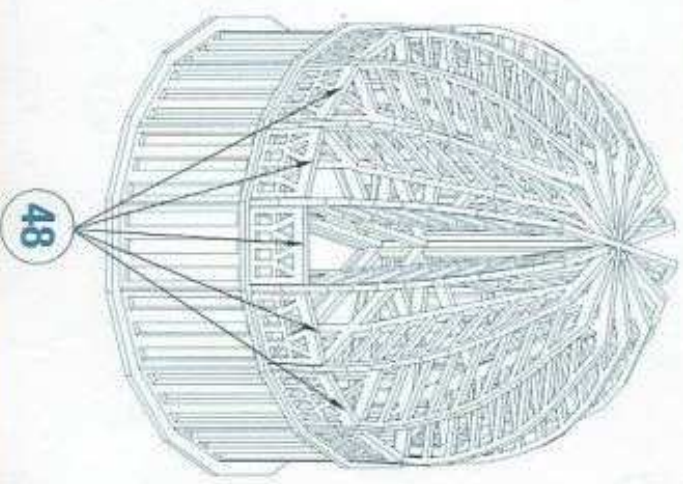
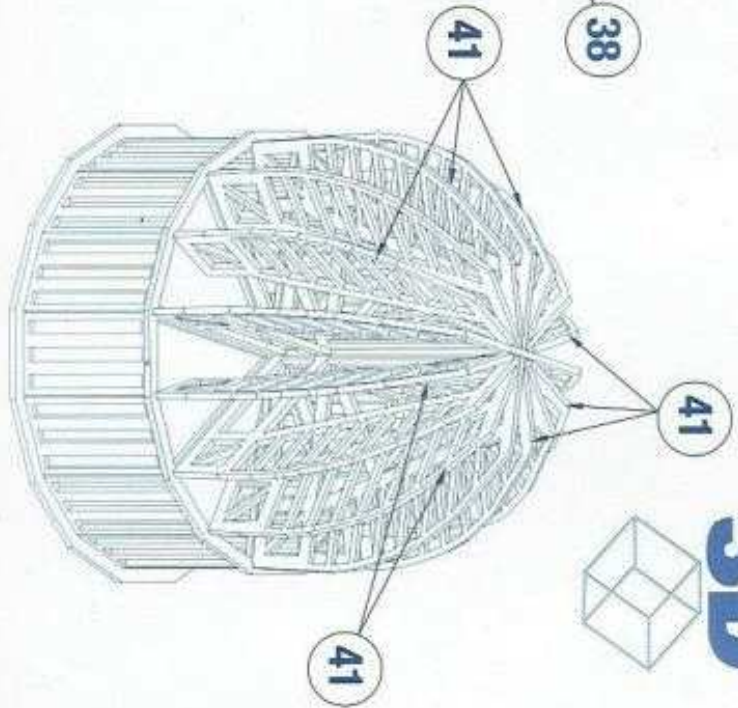
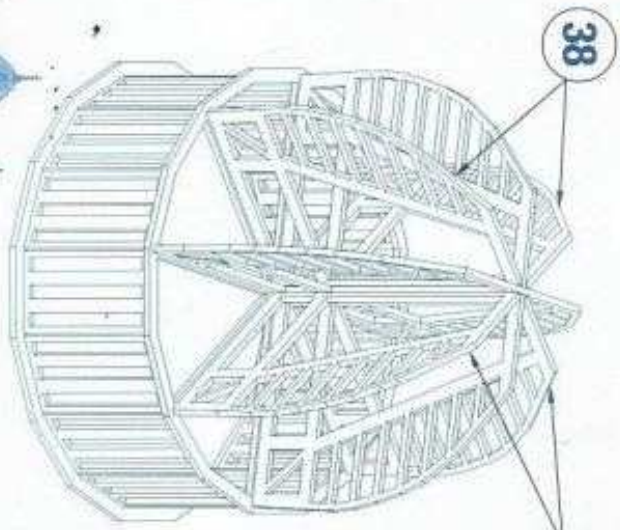
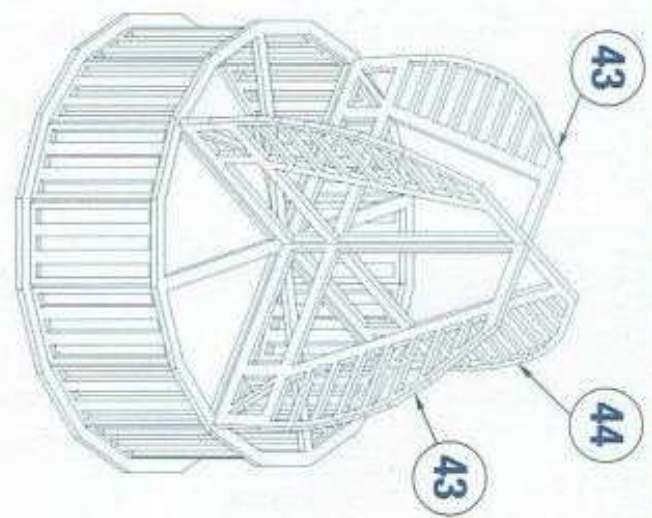
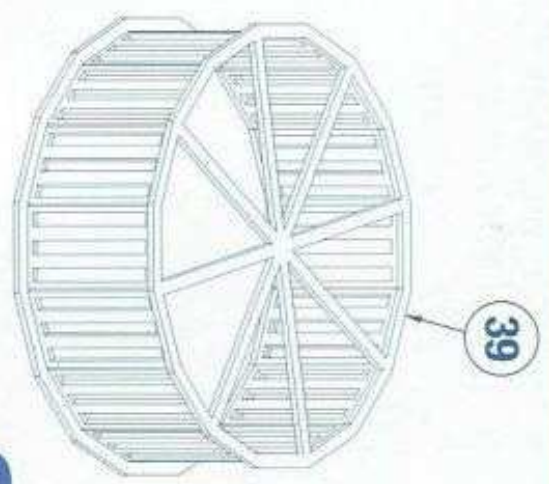
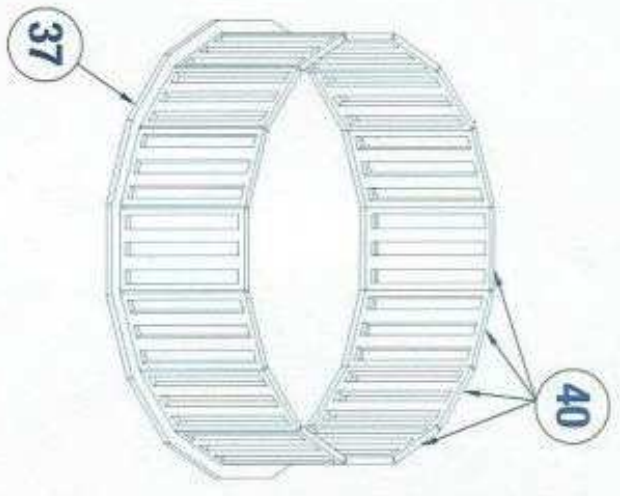

© 2004 Regnier, Inc.

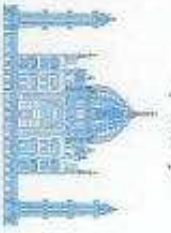
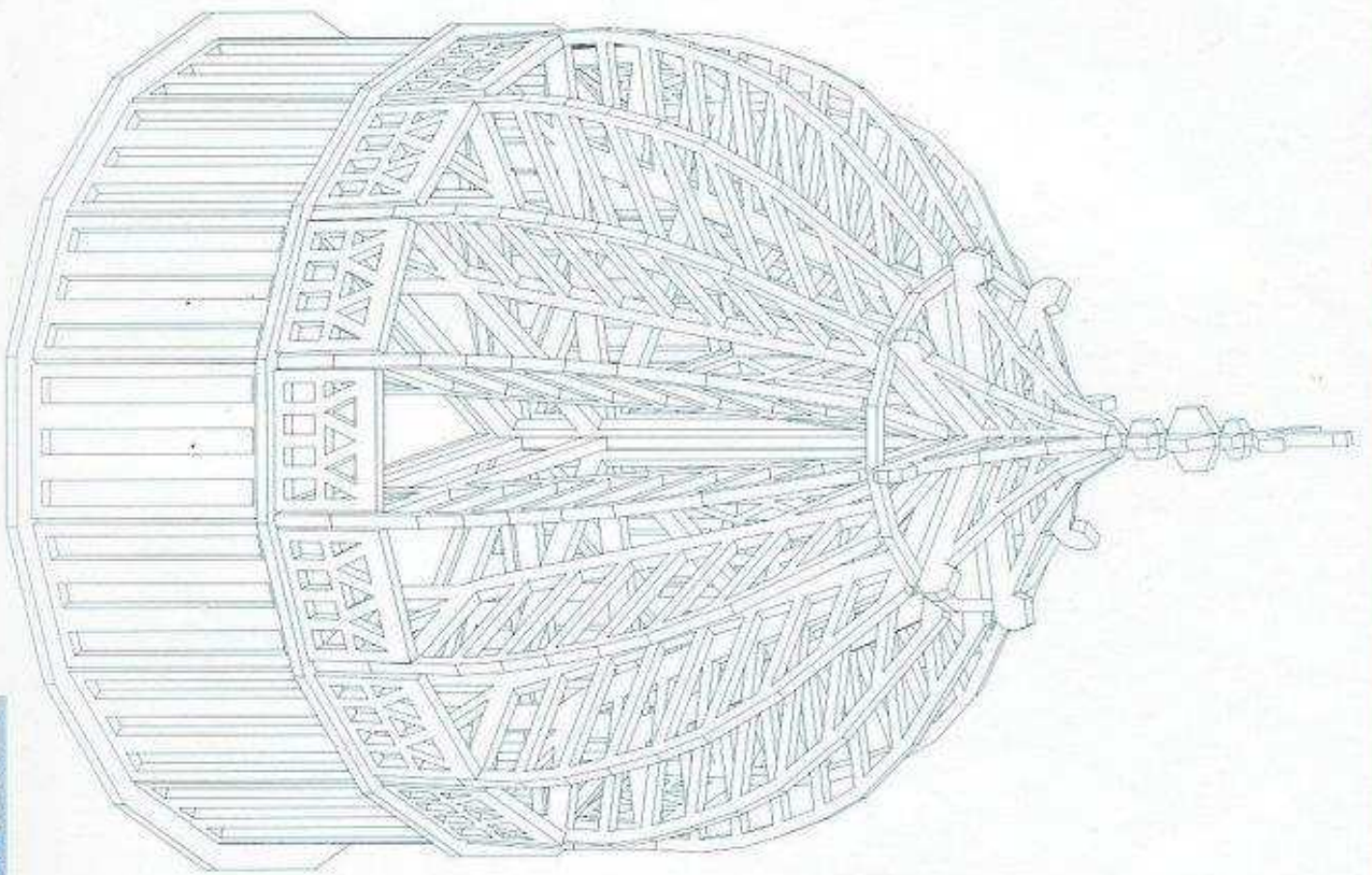

© 2004 Egelex Inc.

ARCHITECTURE



3D

42 / 153

4x 52

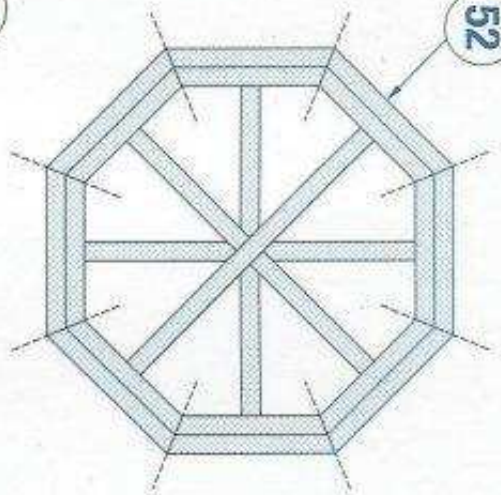

4x 53

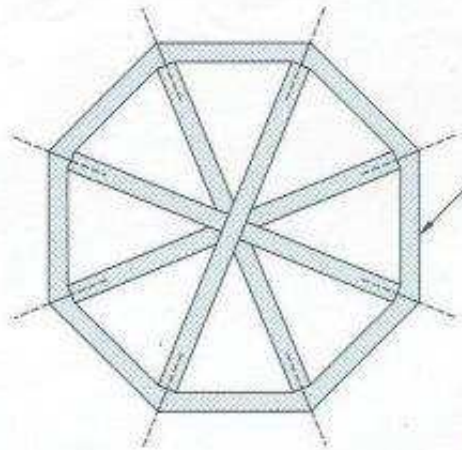

4x 54

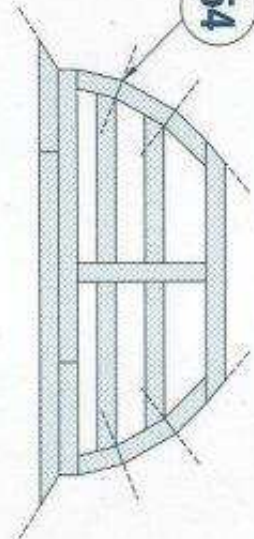

32x 55

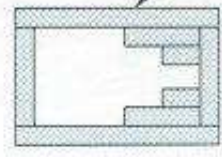

8x 56

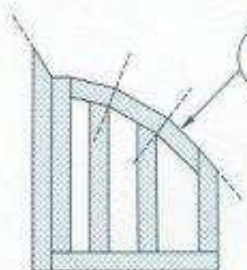

16x 57

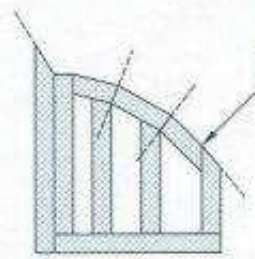

4x 59

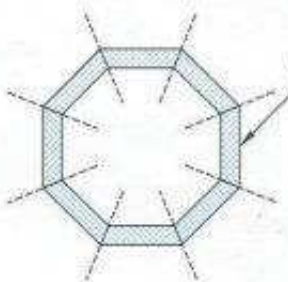

4x 58

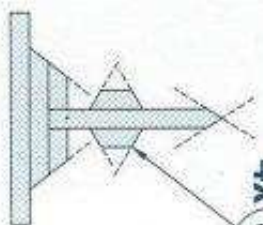

8x 60



8x 61

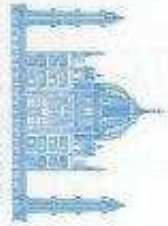

© 2004 Matchitecture, Inc.

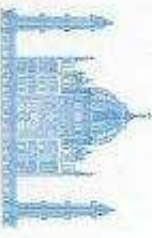
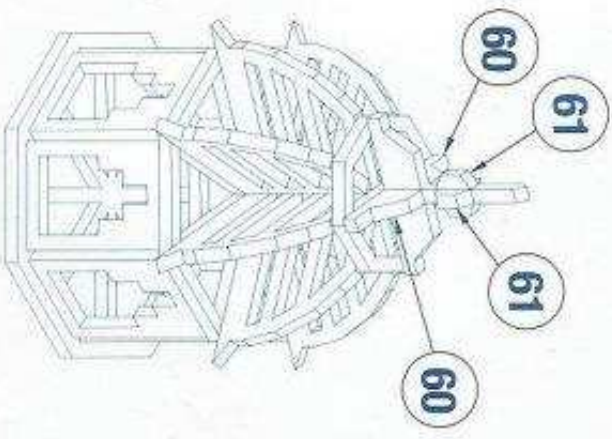
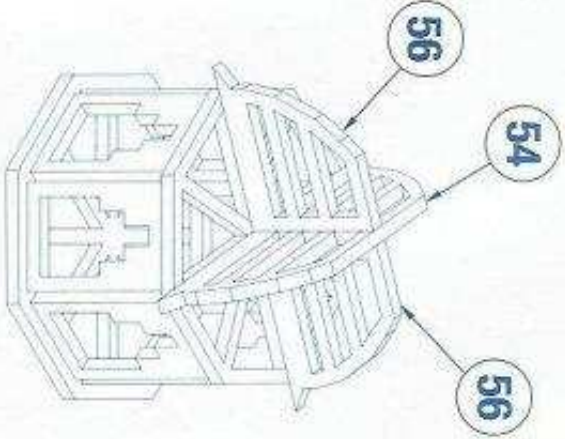
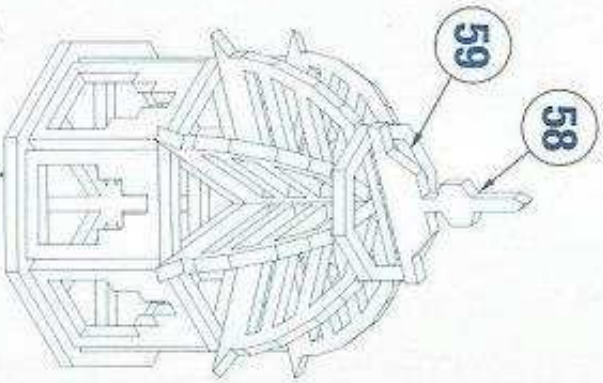
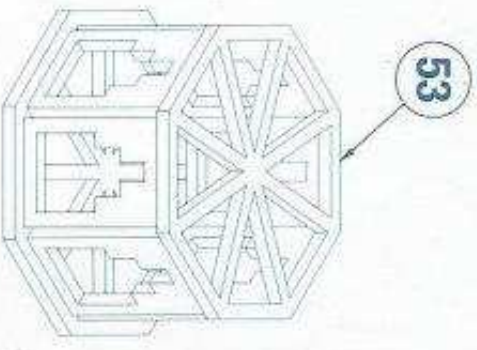
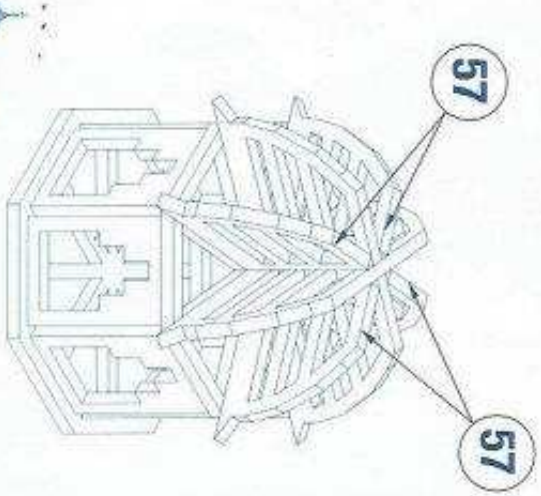
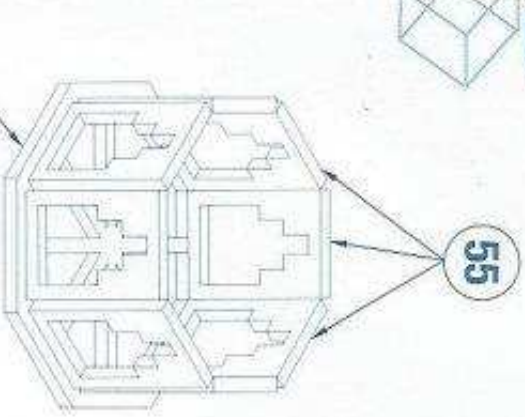

4x 62

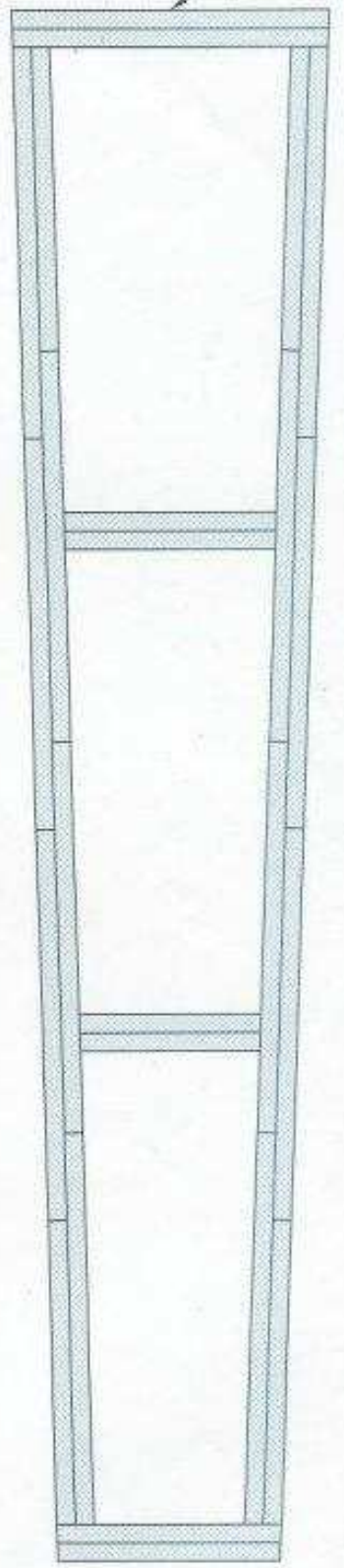

8x 63

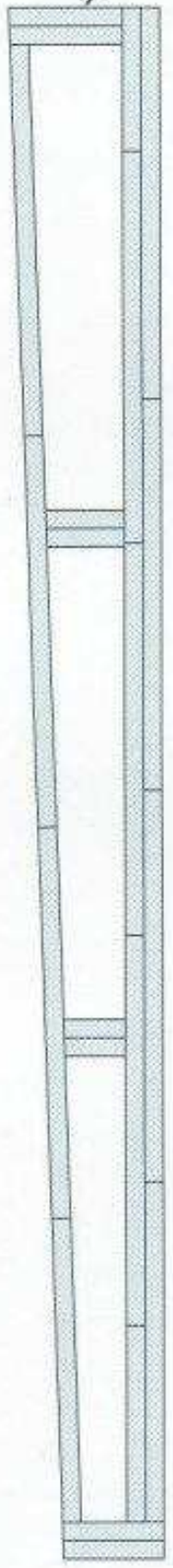

32x 64



32x 65



8x 66

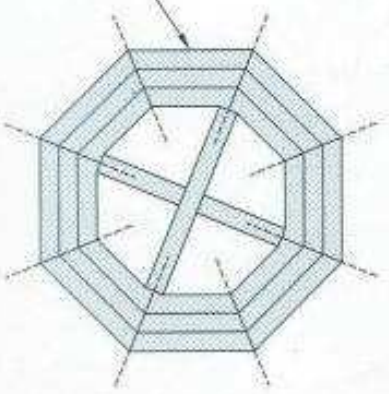

4x 67

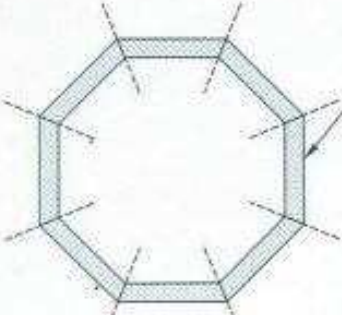

4x 68



4x 69

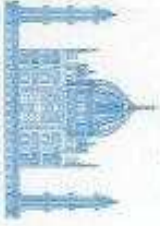
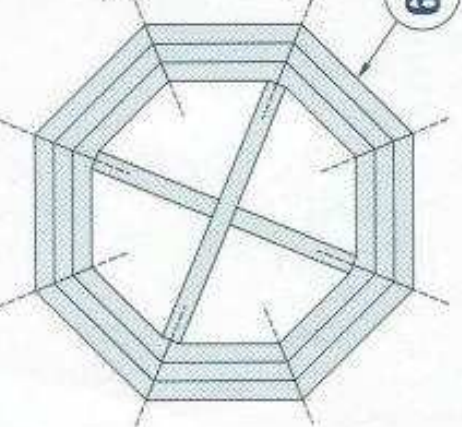

© 2004 Poppen Inc.

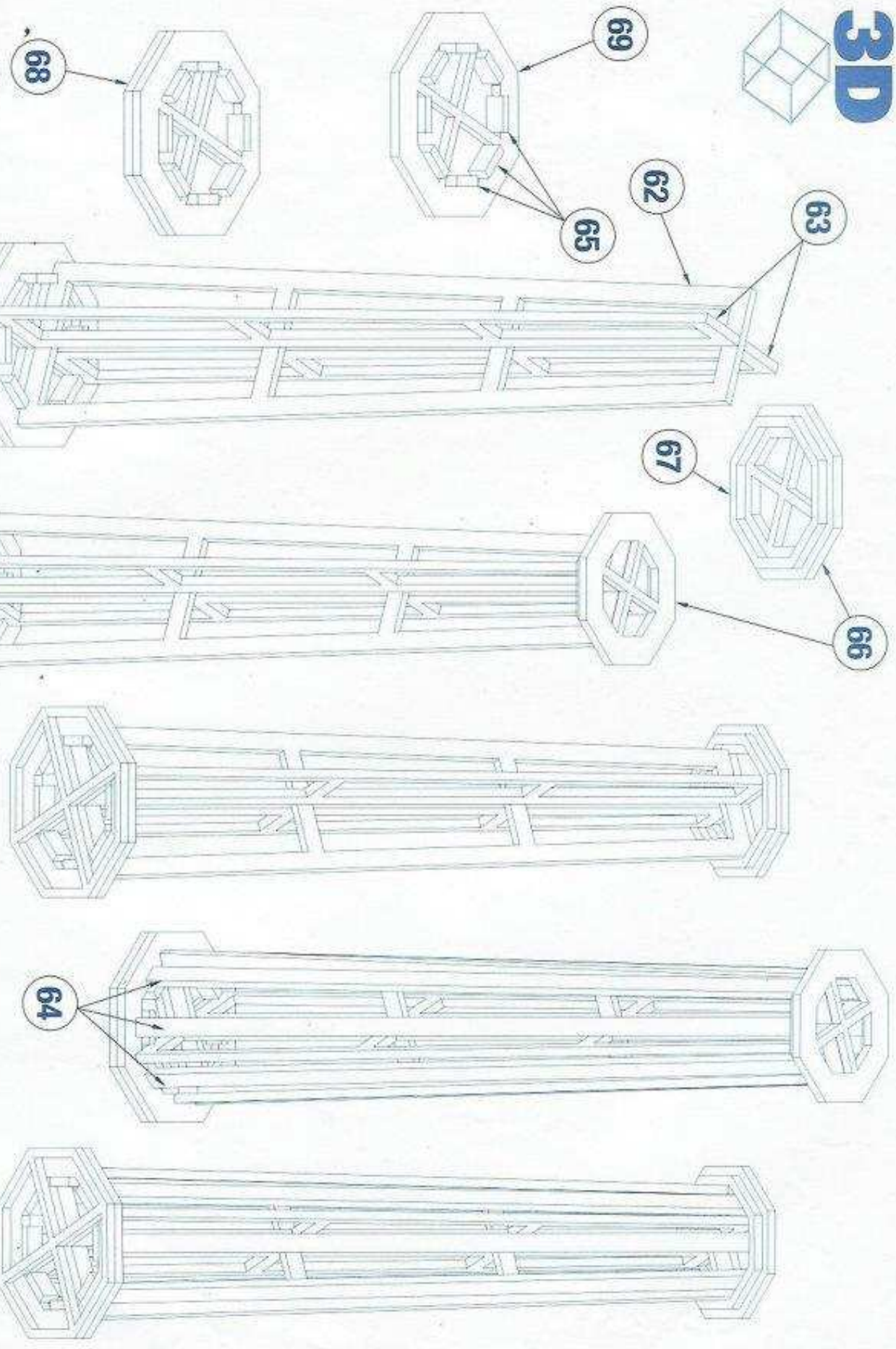

© 2004 Bejane Inc.



© 2004 Regent Inc.

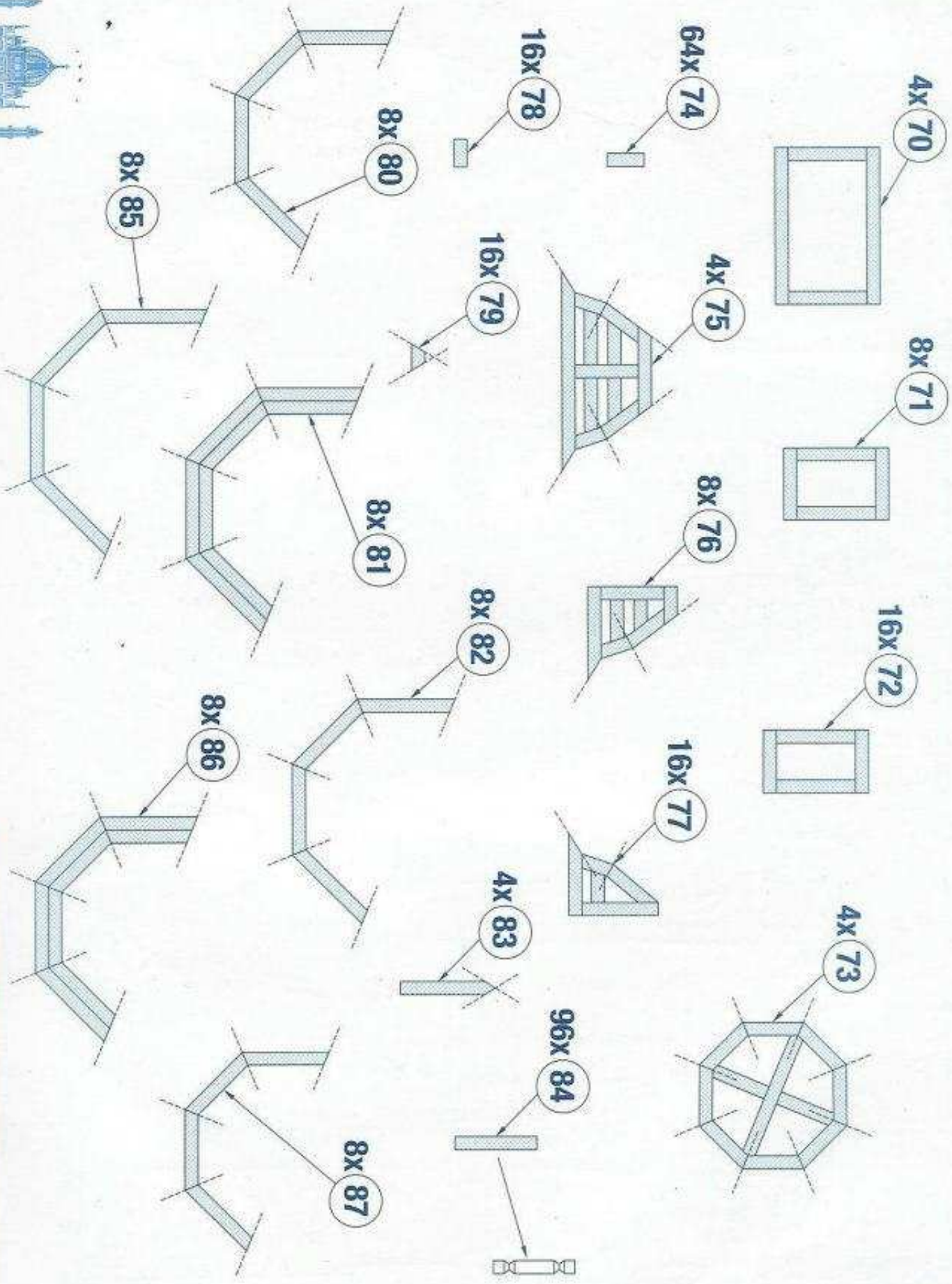

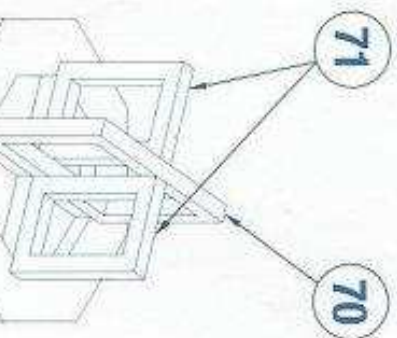

66

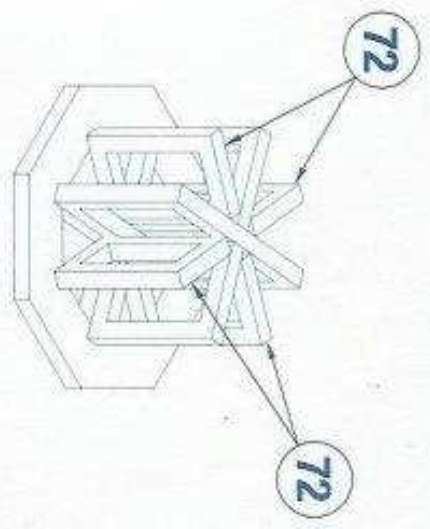
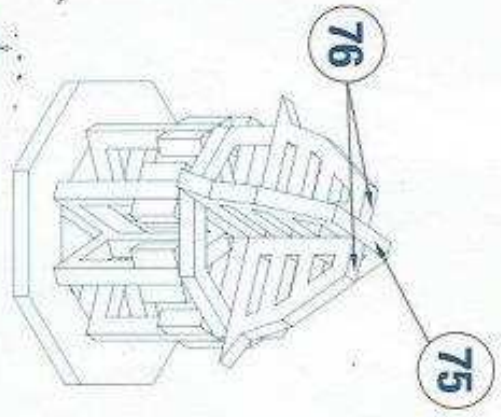

3D

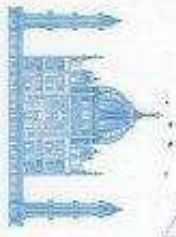
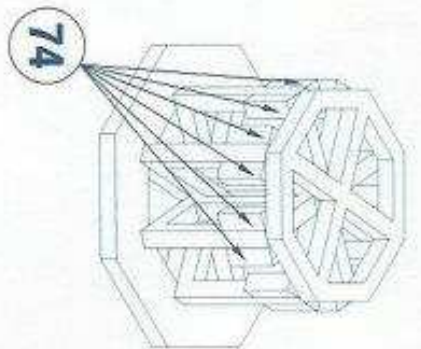
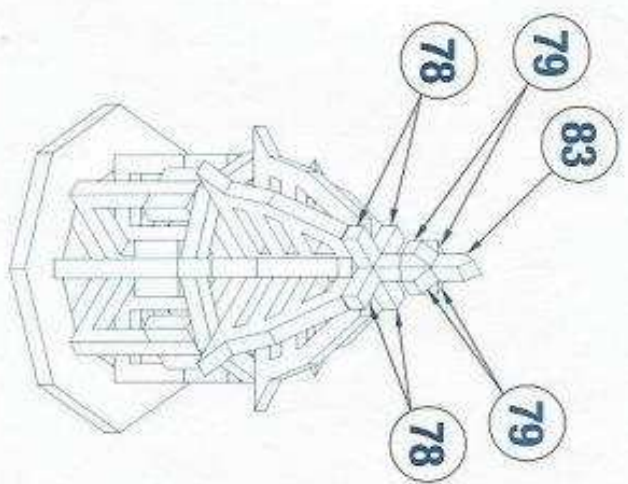
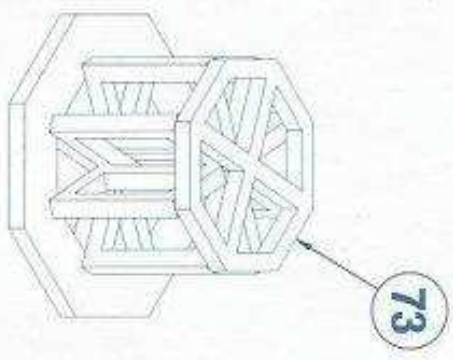
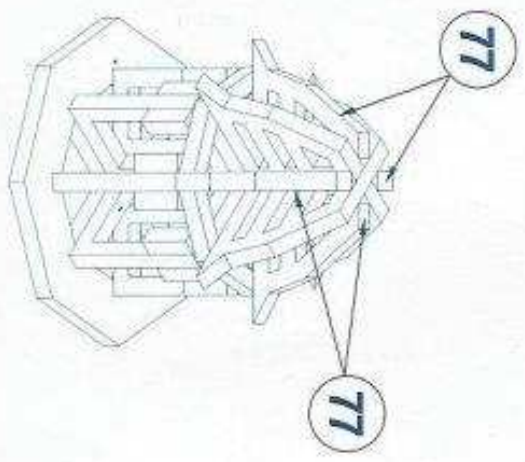

© 2004 Popcorn, Inc.



© 2004 Galaxie, Inc.

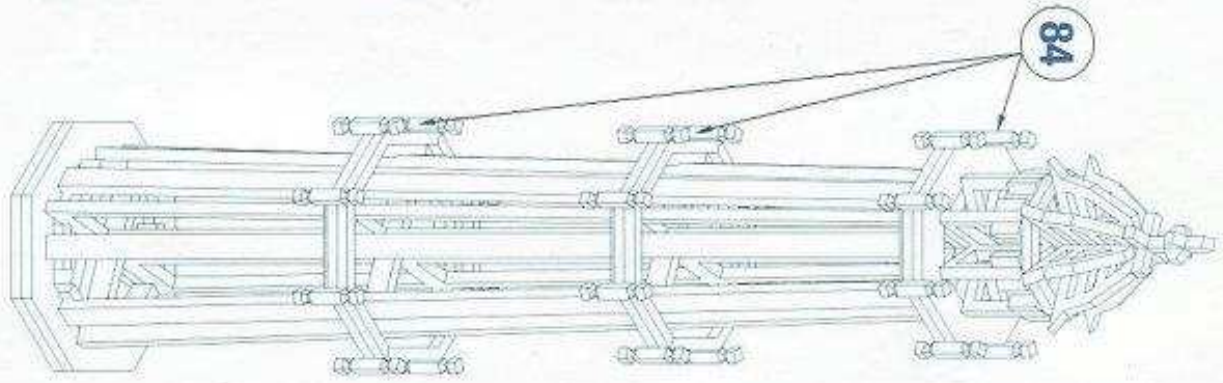
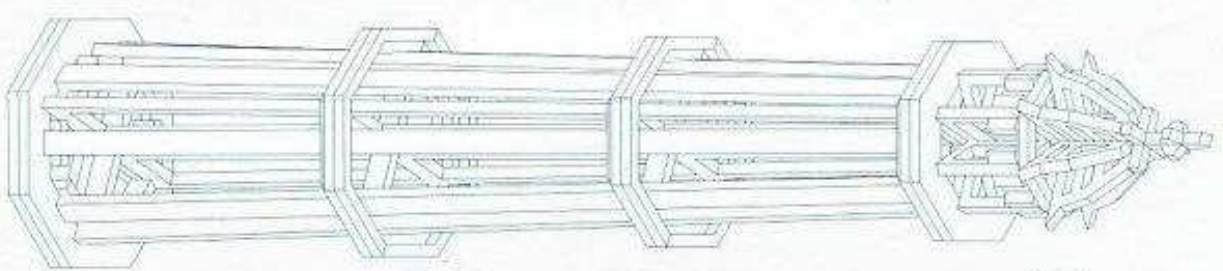
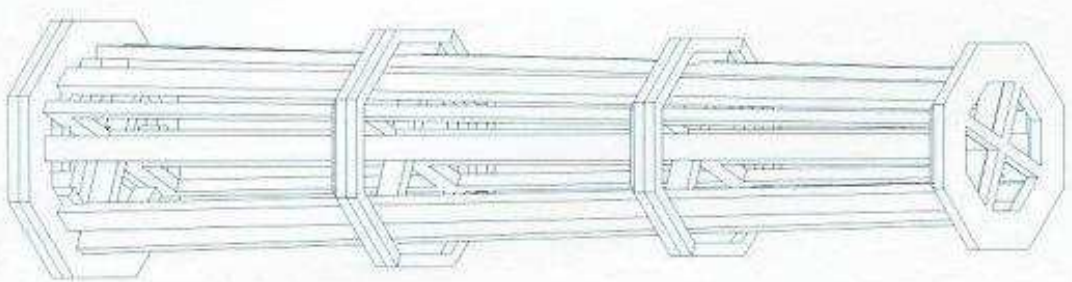
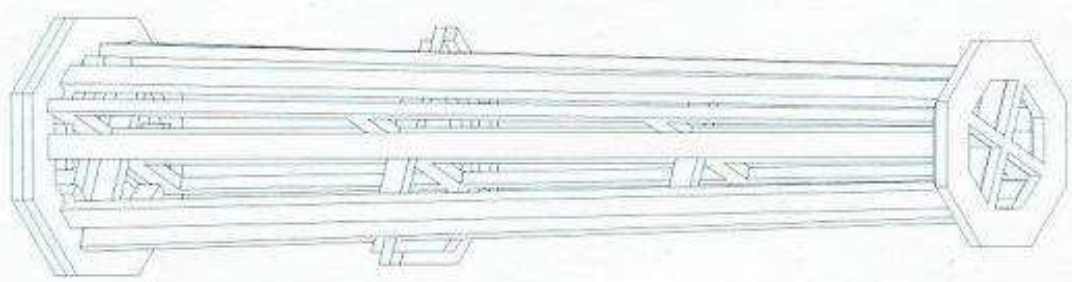
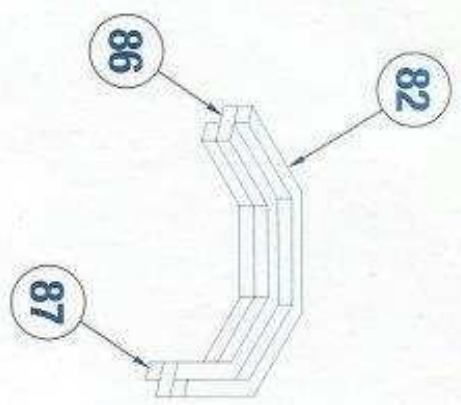
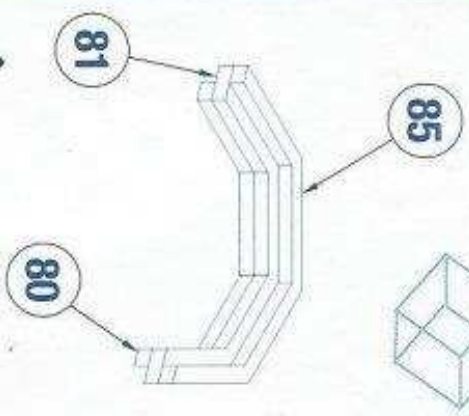

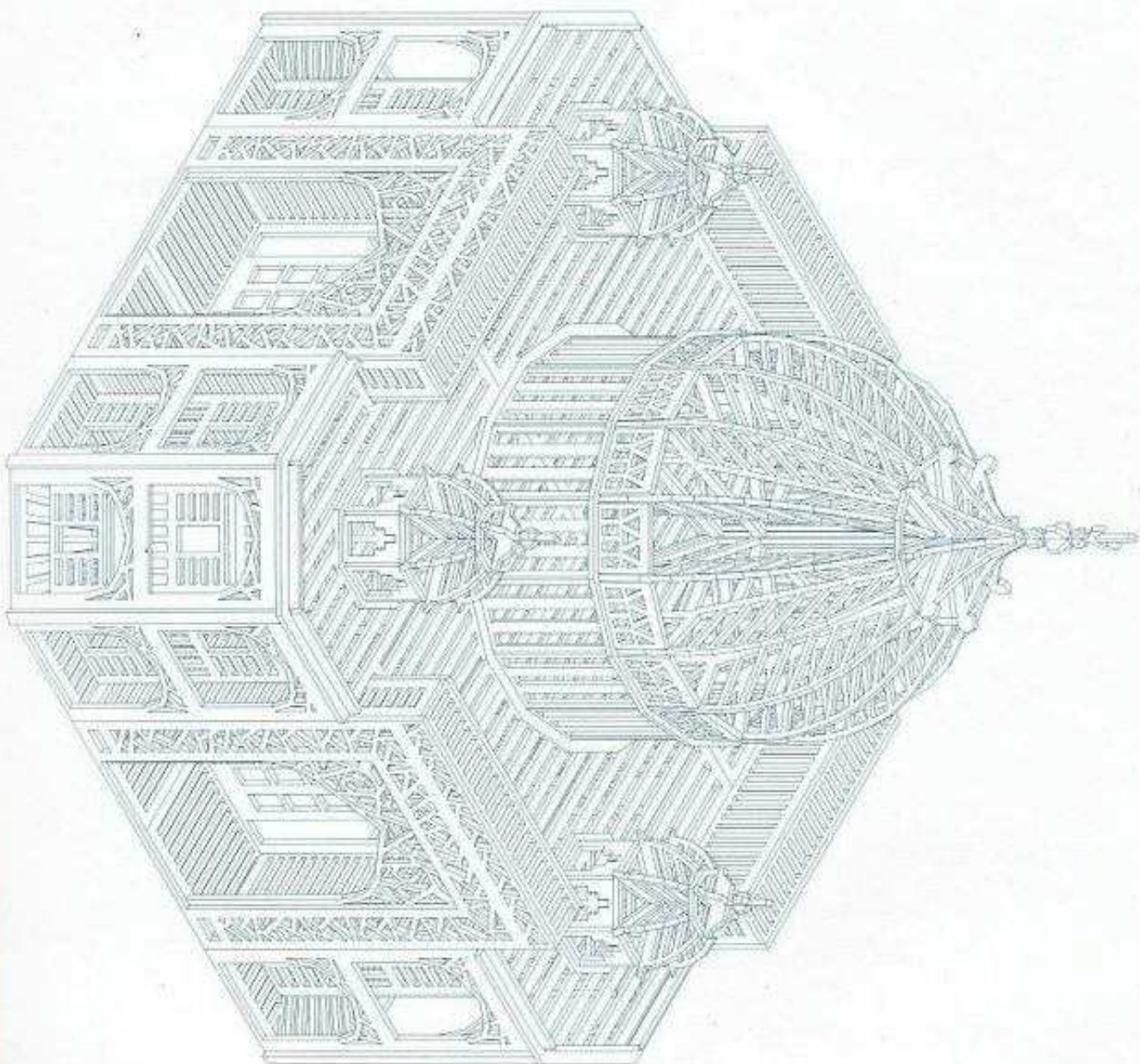

© 2004 Egoon Inc.

ARCHITECTURE



50 / 53

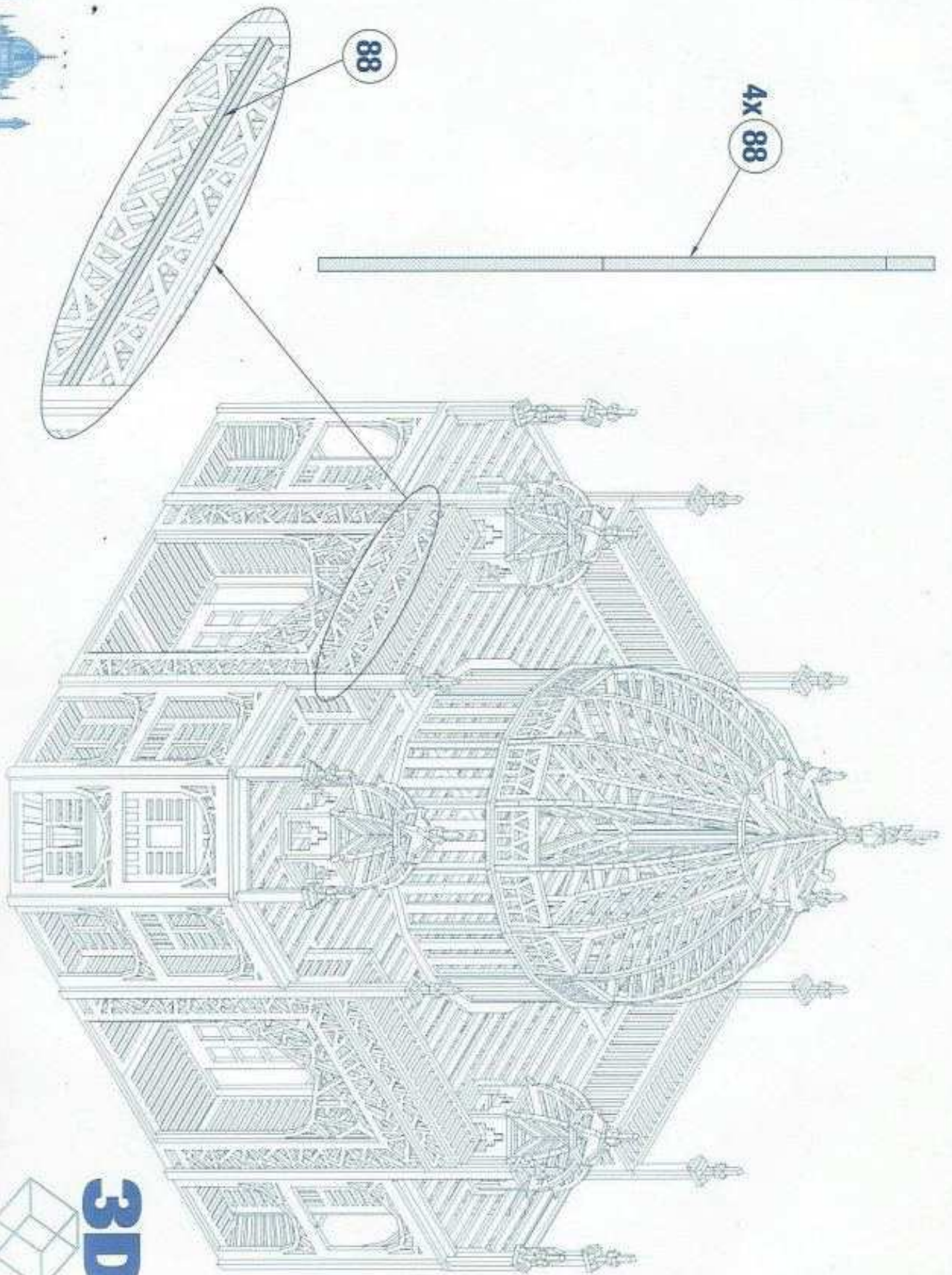

88

4x 88



© 2004 Brown, Inc.

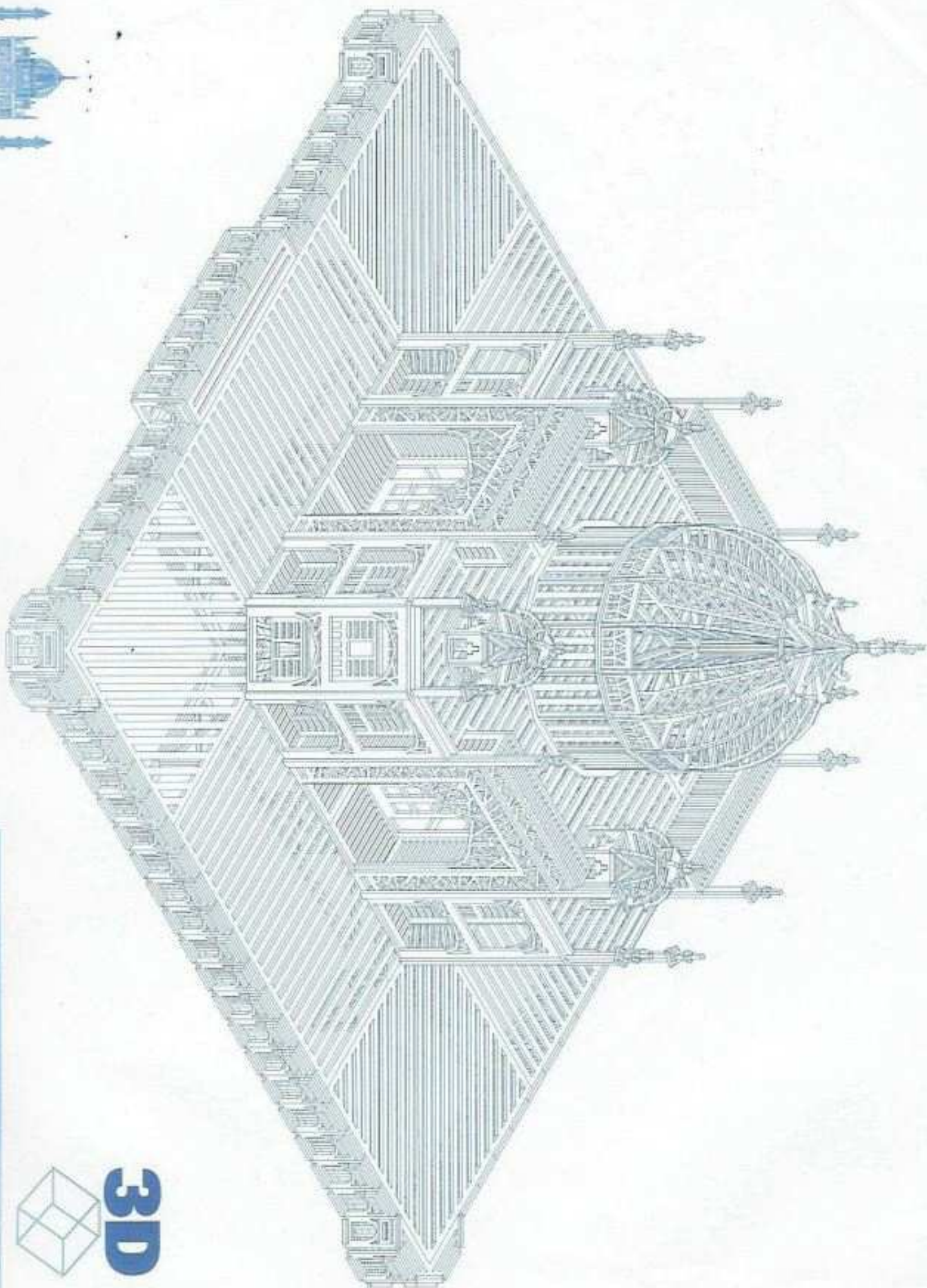

© 2004 Spline, Inc.

MATCHITECTURE

3D

52 / 100

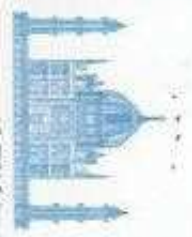
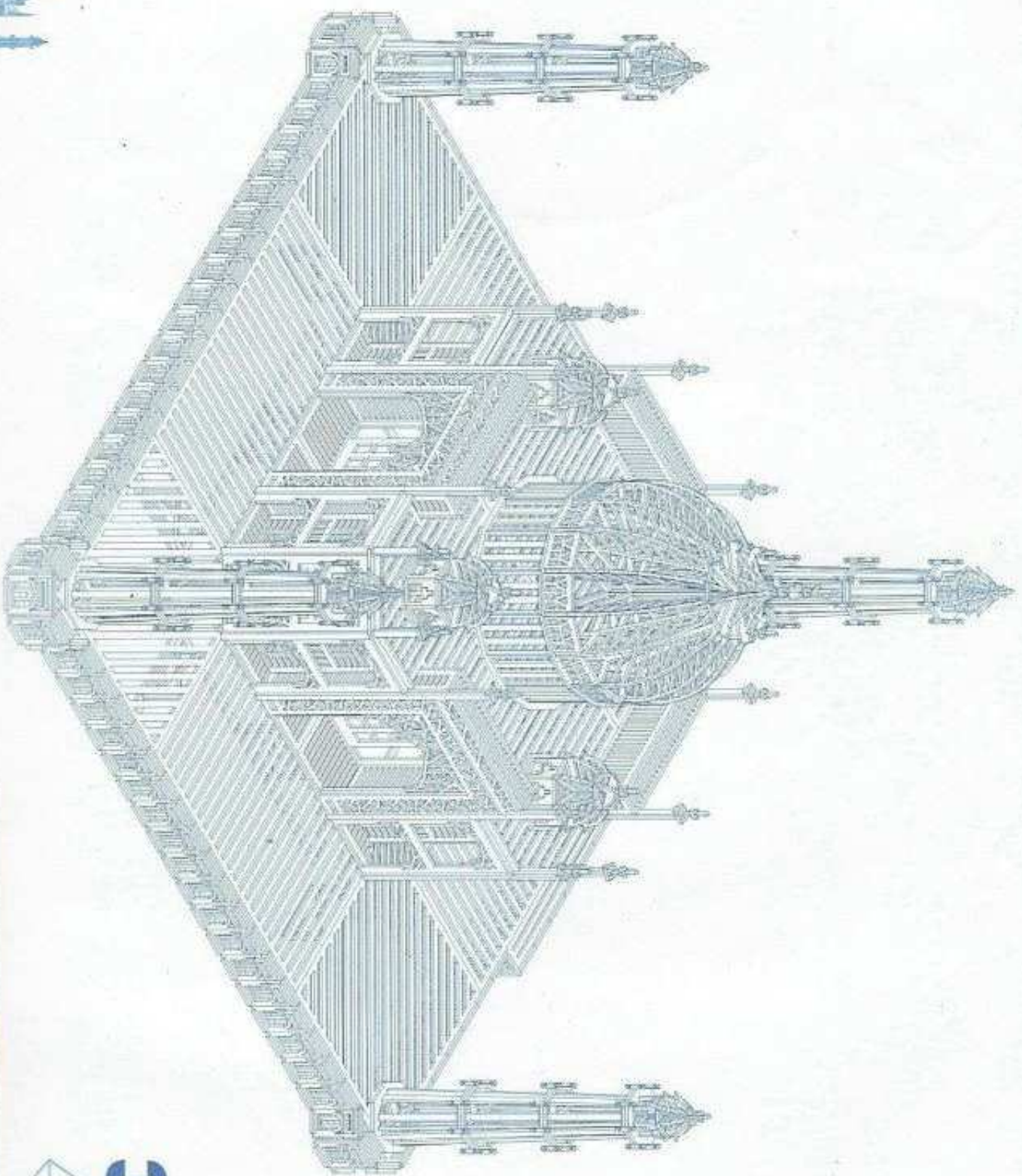

© 2004, Autodesk, Inc.

ARCHITECTURE

3D

53 / 100