

MATCHITECTURE

The Ultimate Building Passion
L'ultime passion de construire
La pasión suprema de construir

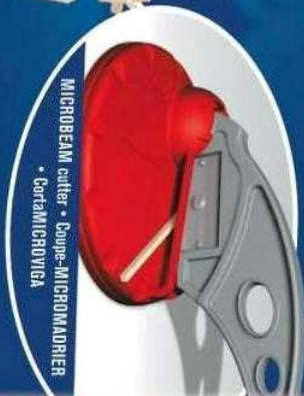

Japanese Bridge
Pont japonais
Puente japonés



MICROBEAM cutter - Coupe-MICROMADRIER
• CortamicroVIGA



MATCHITECTURE

Japanese Bridge
Pont japonais
Puente japonés

#8642



MACHITECTURE

PLANS • PLANOS • PIANI • ZEICHNUNGEN • PLANNEN • 設計図

Contents:

- 1 assembly board with clear acetate sheet
- 1 MICROBEAM cutter
- 500 MICROBEAMS (2 1/8"/53 mm)
- 1 wood glue (4 oz./120 ml)
- 1 MICROBEAM tweezers
- plans
- instructions

Contenu :

- 1 feuille d'acétate transparente
- 1 coupe-MICROMADRIER
- 500 MICROMADRIERS (53 mm/2 1/8")
- 1 colle
- 1 pince à MICROMADRIERS
- plans
- instructions

Inhalt:

- 1 montageplatte mit durchsichtigem Acetatblatt
- 1 MIKROSTÄBSchneider
- 500 MIKROSTÄBE (53 mm/2 1/8")
- 1 Holzleim (120 ml/4 oz.)
- 1 pinzette für die MIKROSTÄBE
- zeichnungen
- vorlagen

Contenido:

- 1 tablero de ensamblaje con hoja de acetato transparente
- 1 cortamicroviga
- 500 microvigas (53 mm/2 1/8")
- 1 pegamento de madera (120 ml/4 oz.)
- 1 pinza para microvigas
- planos
- instrucciones

Inhoud:

- 1 montagebord met transparant blad van acetaat
- 1 snijder voor MICROBALKJES
- 500 MICROBALKJES (53 mm/2 1/8")
- 1 houtlijm (120 ml/4 oz.)
- 1 pincet voor MICROBALKJES
- plannen
- gebruiksaanwijzingen

Contenuto:

- 1 tavola d'assemblaggio con foglio in acetato trasparente
- 1 tagliatrice per MICROTRAVI
- 500 MICROTRAVI (53 mm/2 1/8")
- 1 colla per legno (120 ml/4 oz.)
- 1 pinzetta per MICROTRAVI
- plani
- istruzioni

内容:

- 1 透明シートと組み立てボード
- 1 マイクロビームカッター
- 500 マイクロビーム (53mm/2 1/8")
- 1 木工用糊 (120ml/4 oz)
- 1 マイクロビームピンセット
- 設計図
- 使用説明書

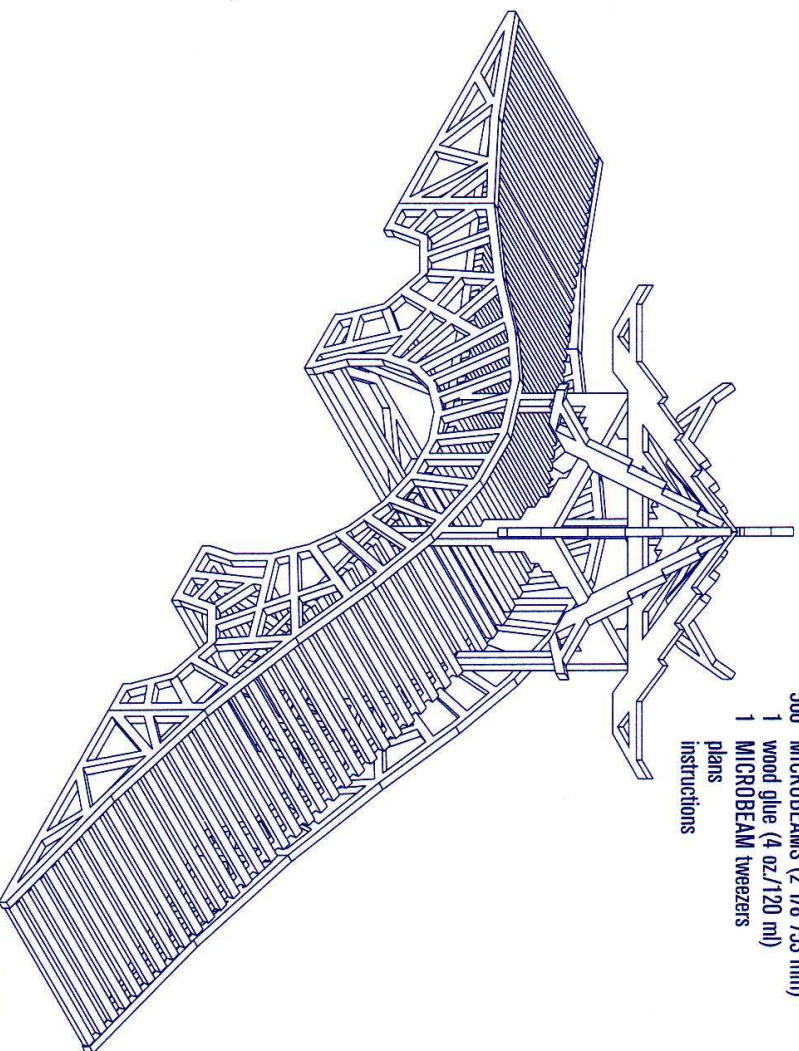

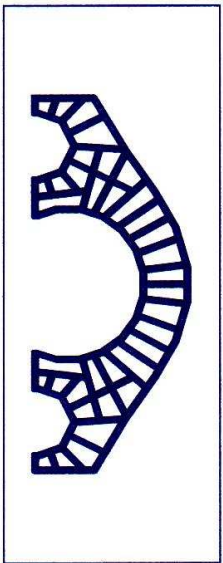
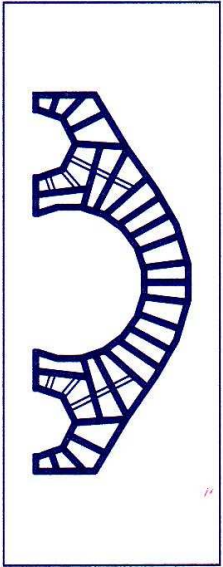
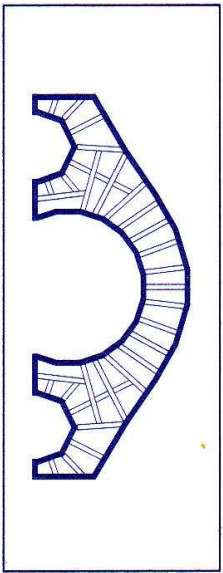

2 X 1

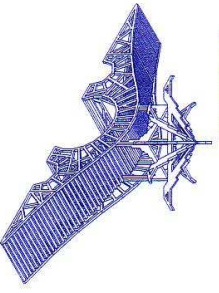
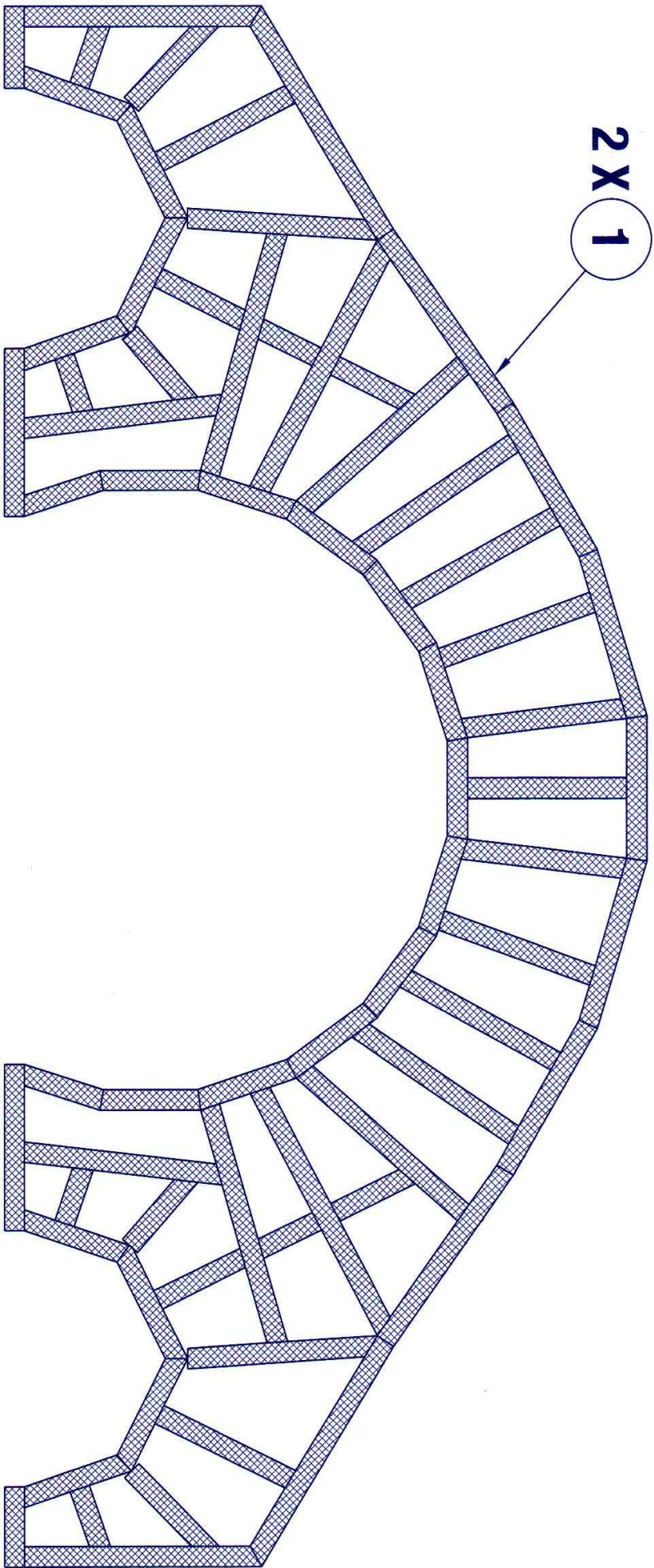

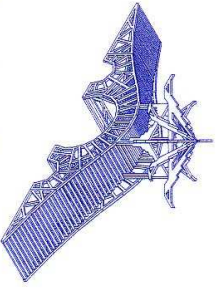
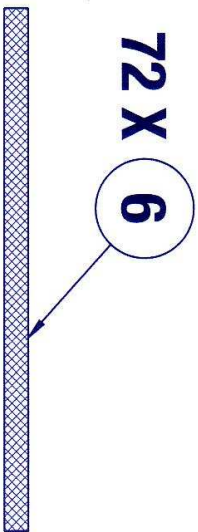
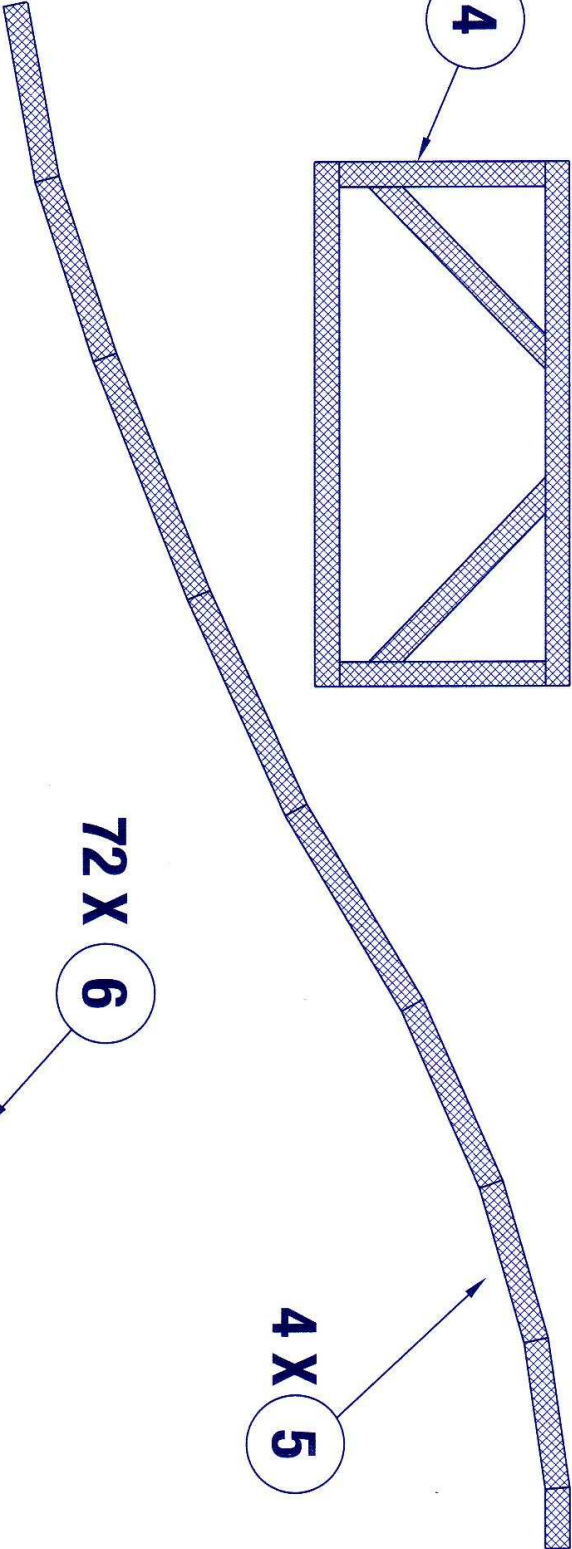
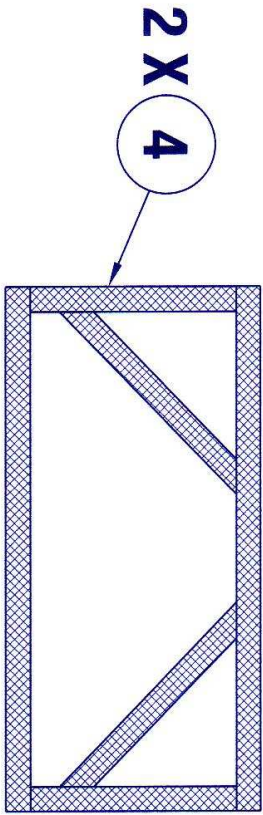
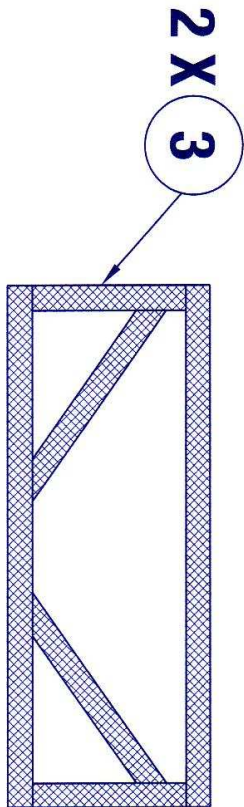
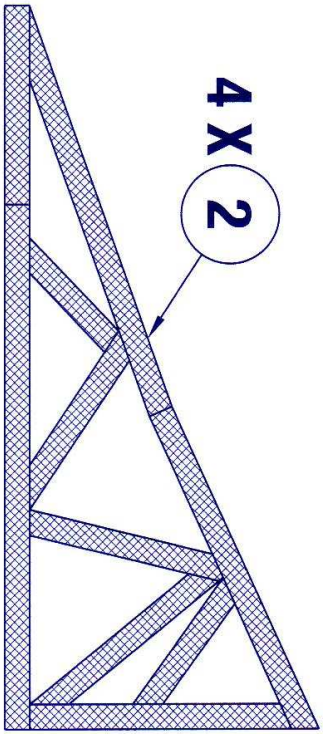

3D

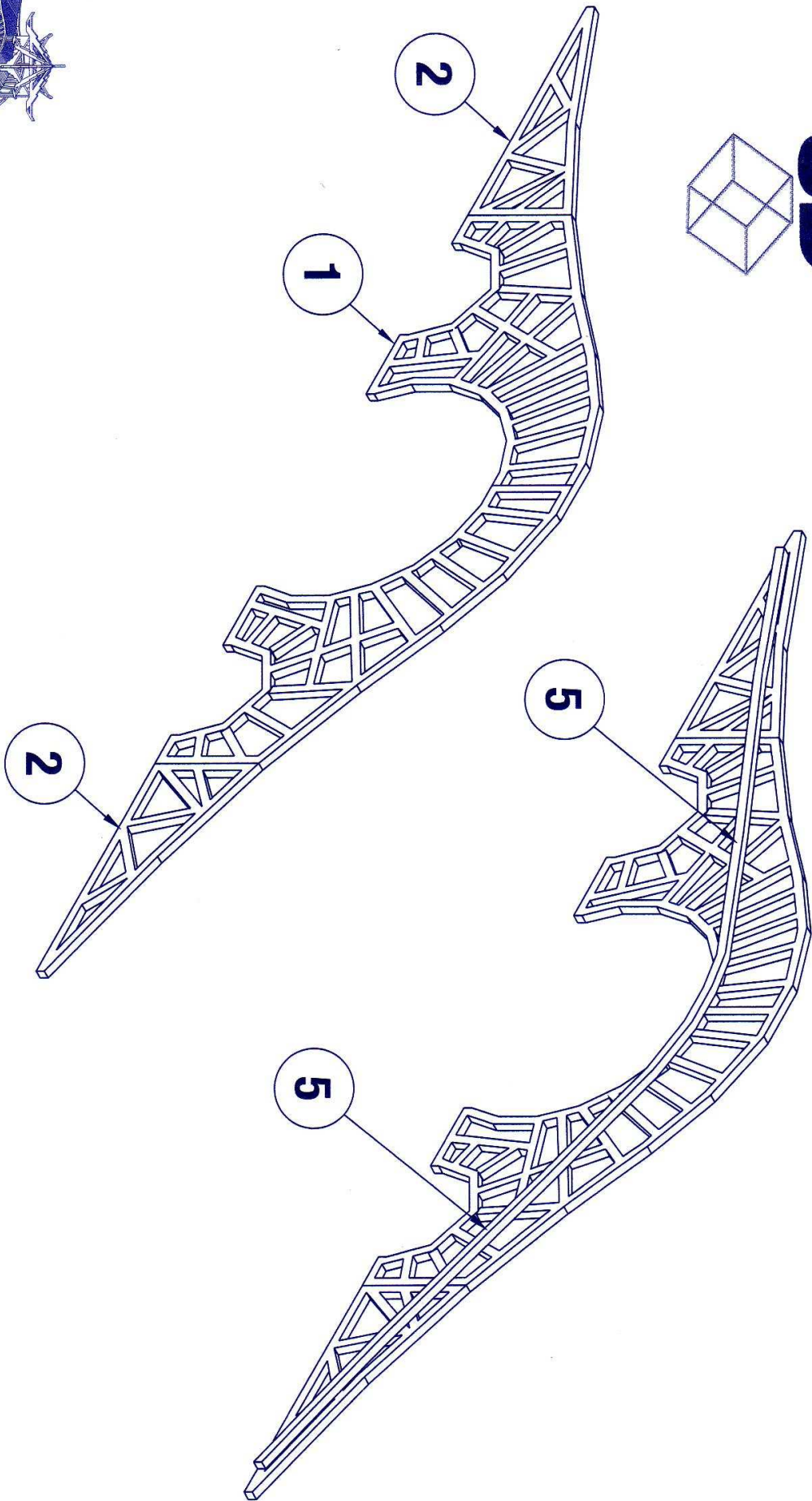
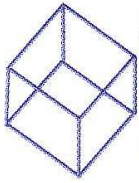

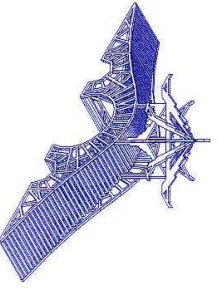
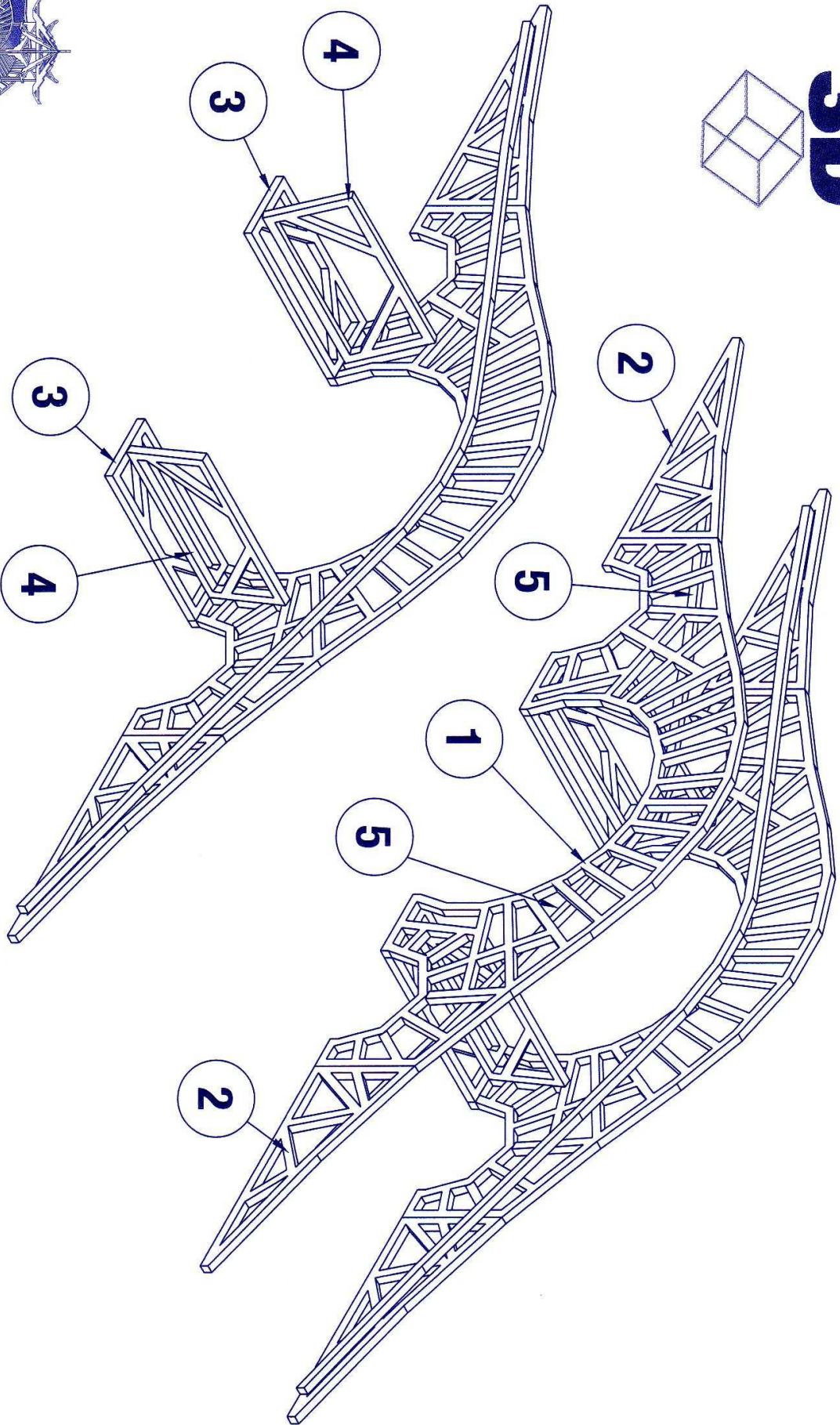
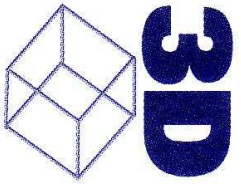

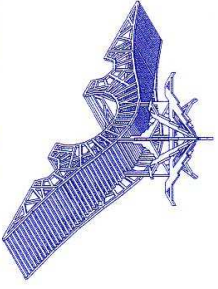
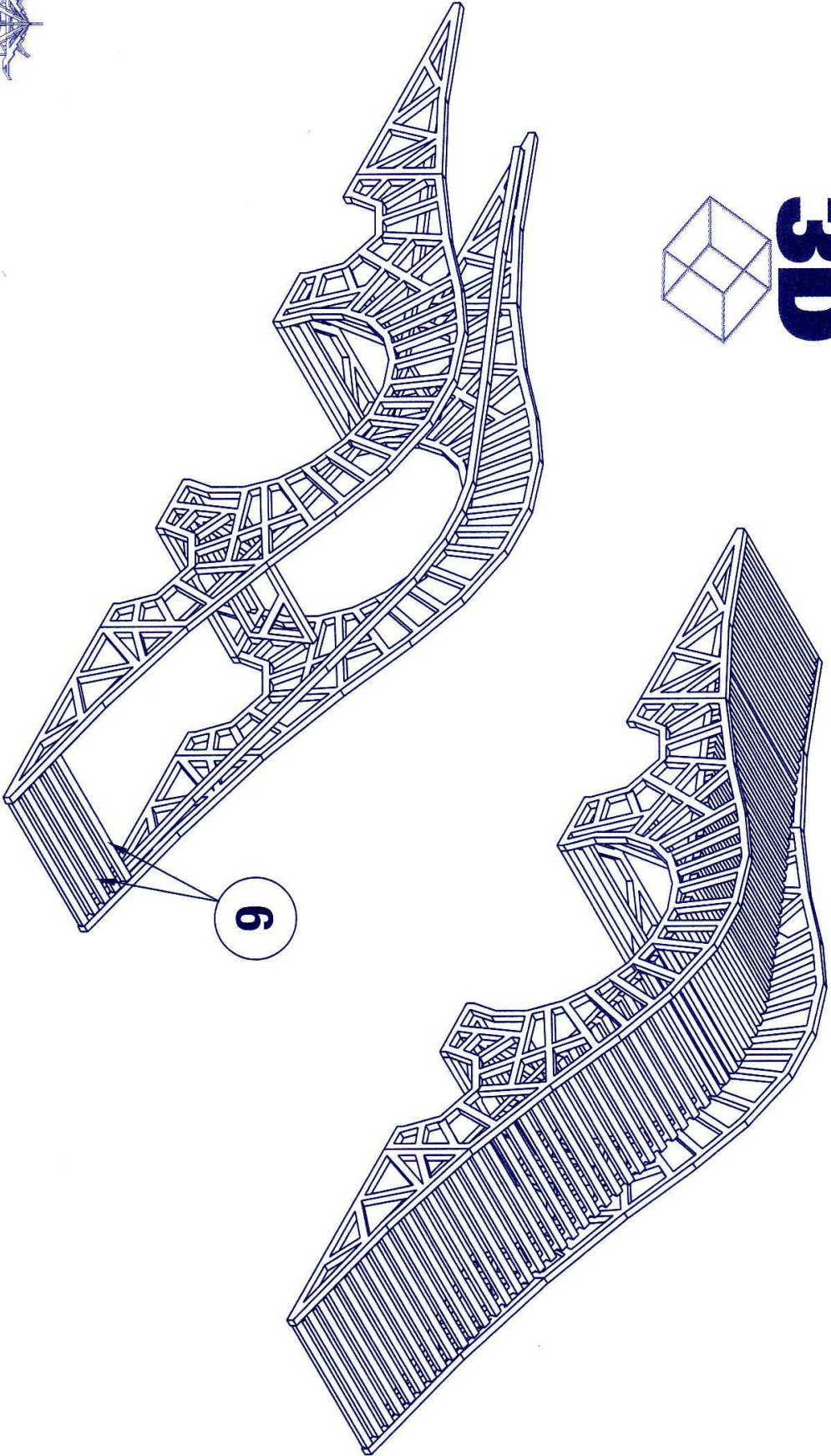
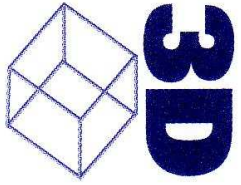

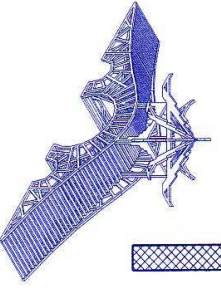
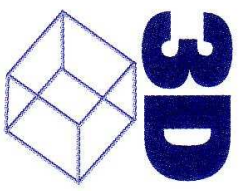
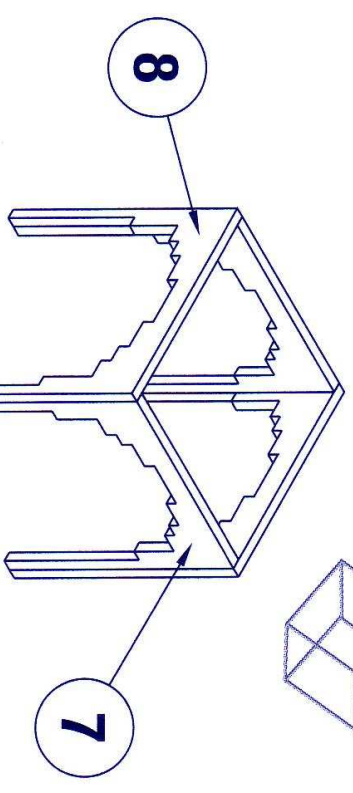
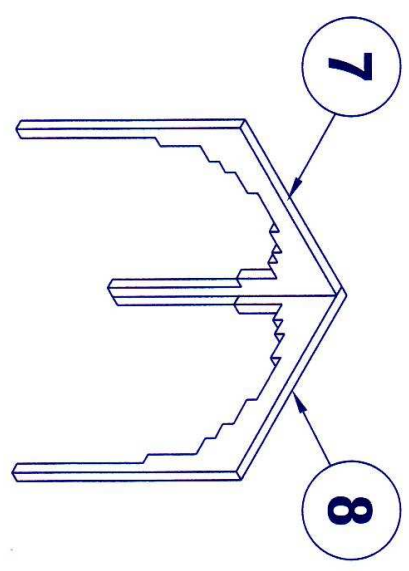
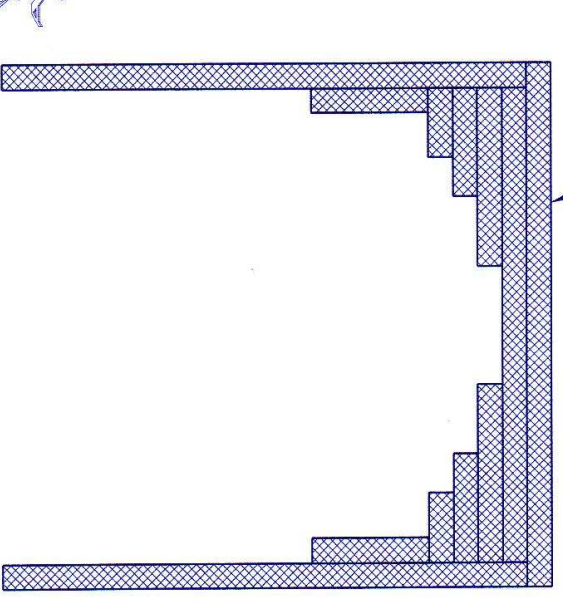
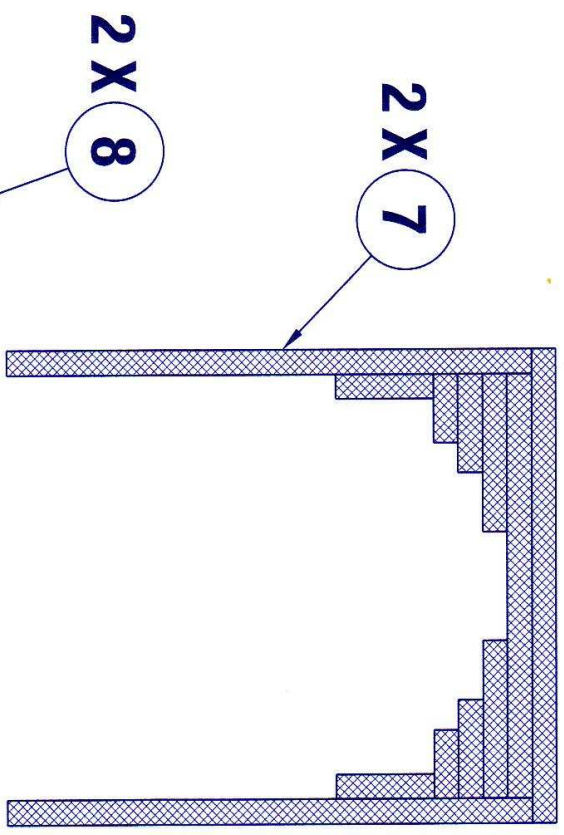

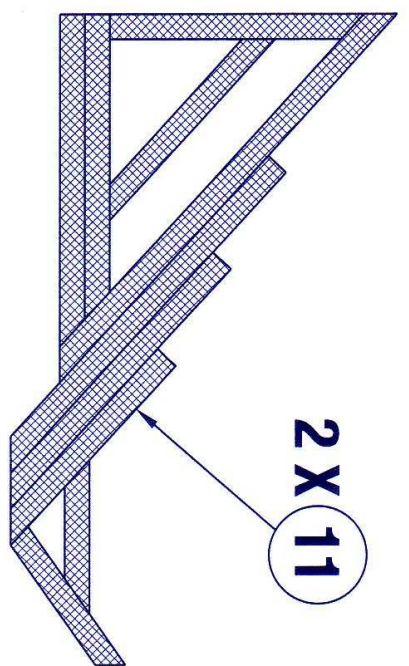
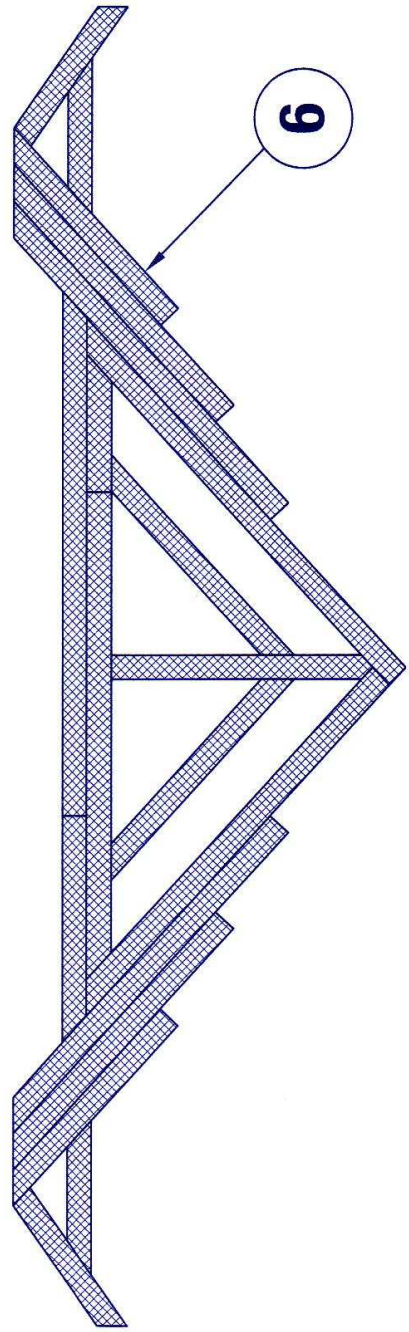
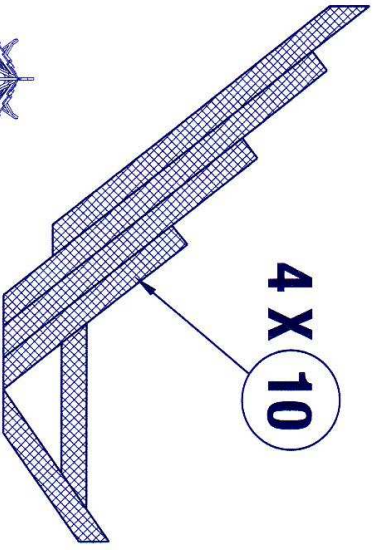
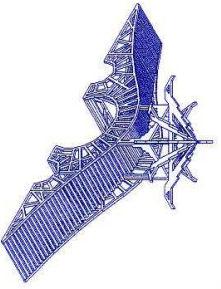

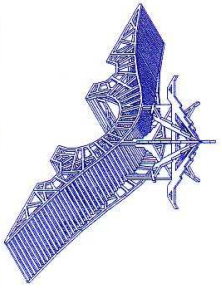
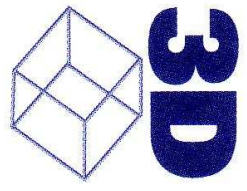
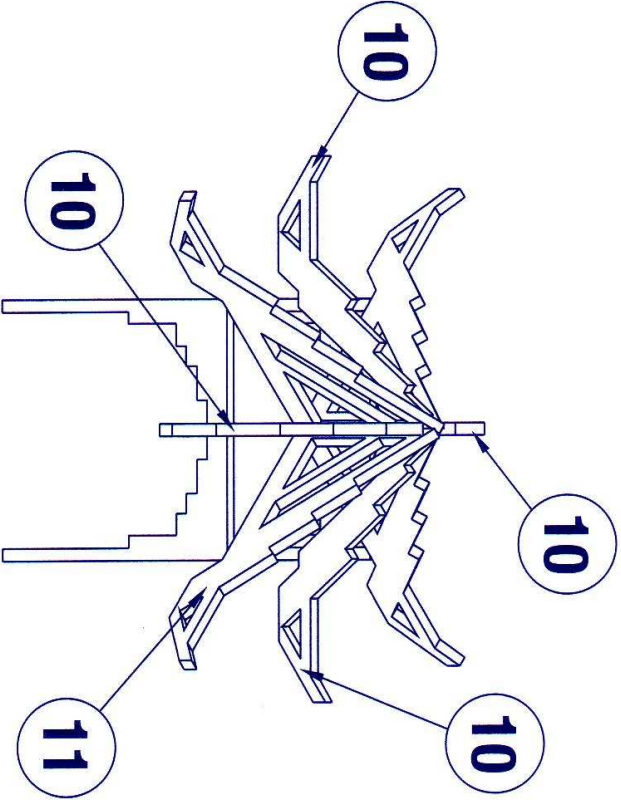
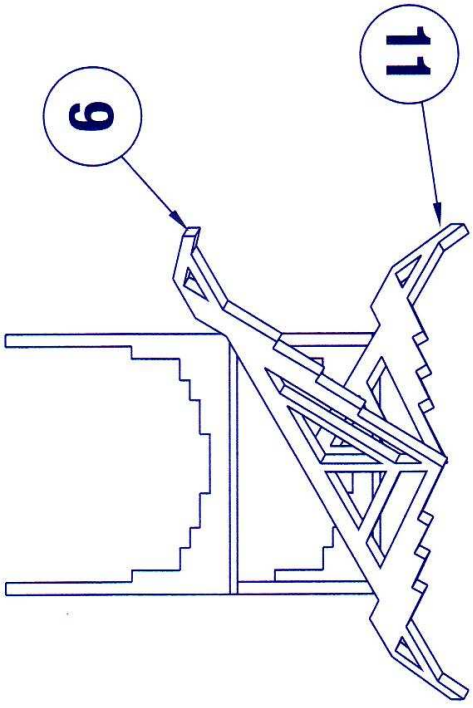
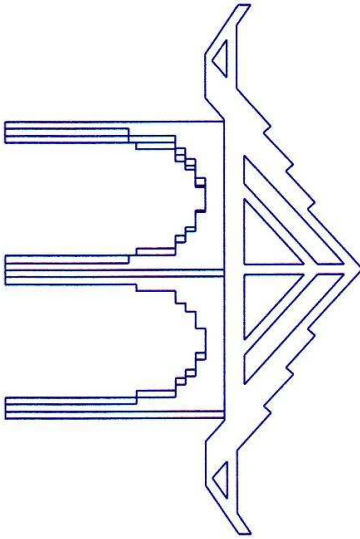

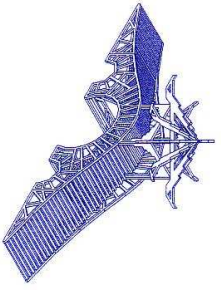
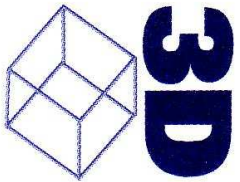
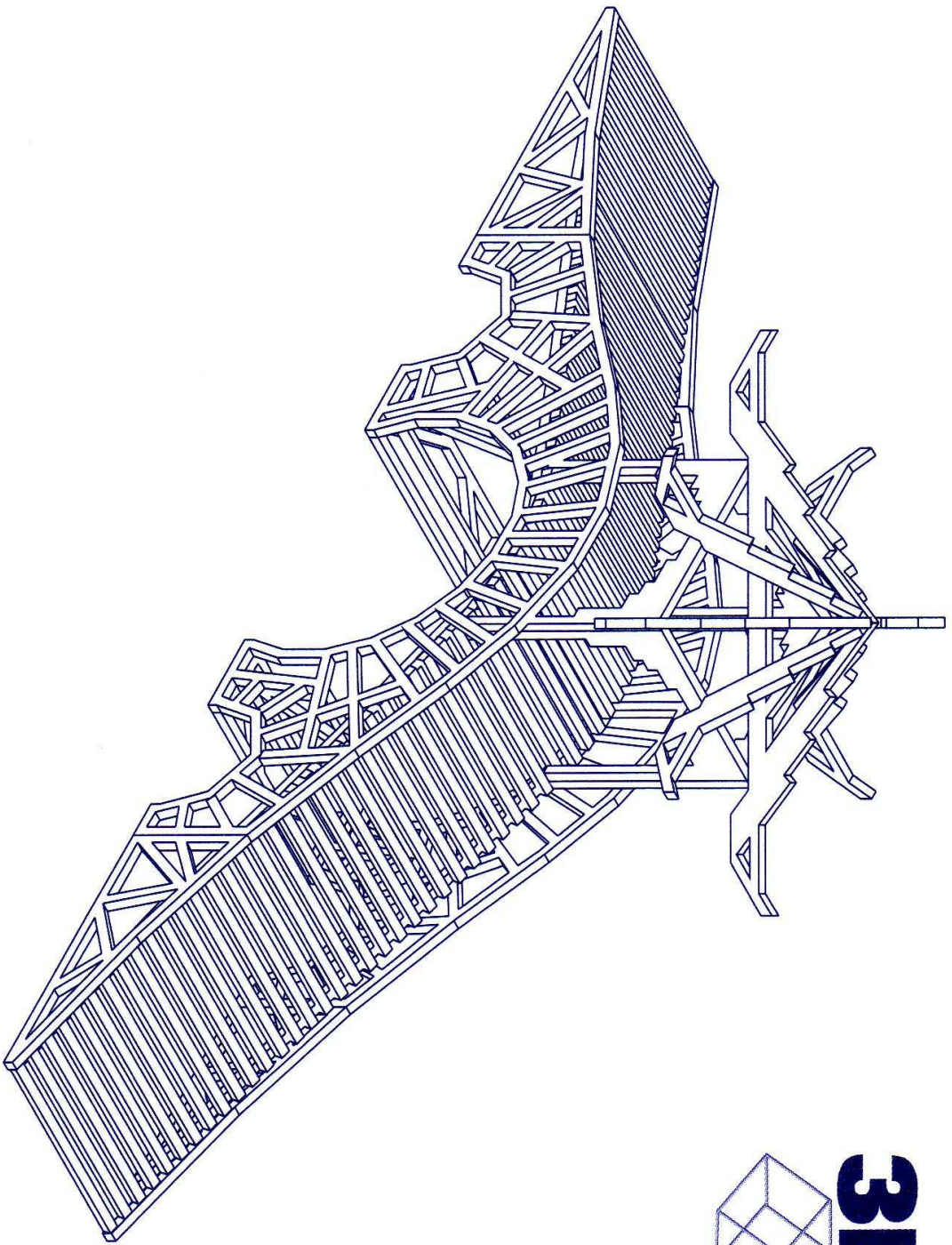

© 2002 Jouets Bô-Jeux toys inc.

www.machitecture.info

MACHITECTURE

9
/18

2 X 12

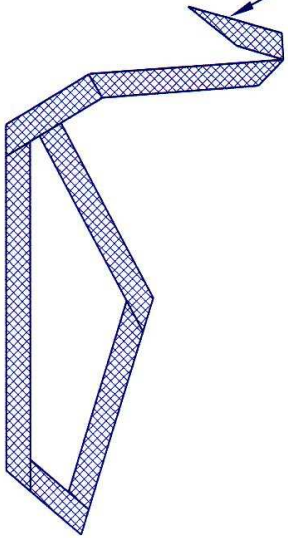

2 X 13

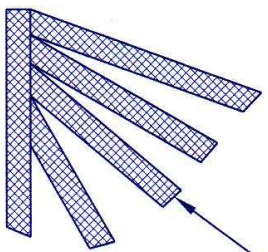

2 X 15

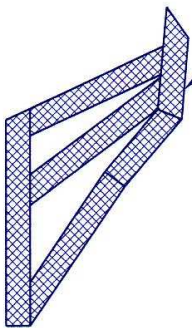

4 X 14

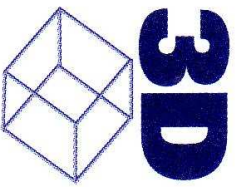
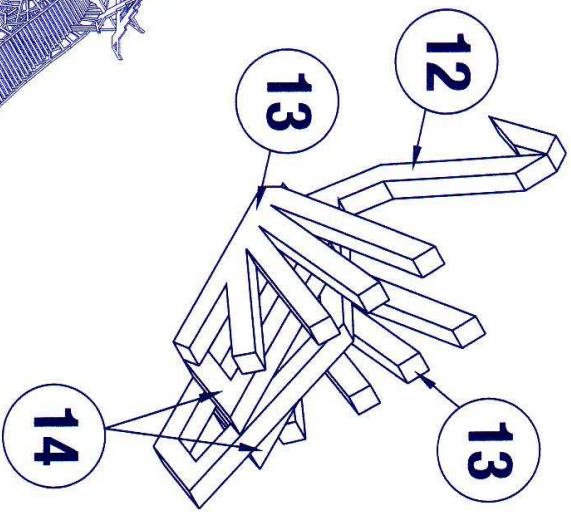
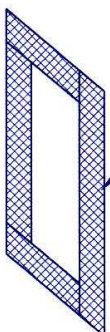

3D

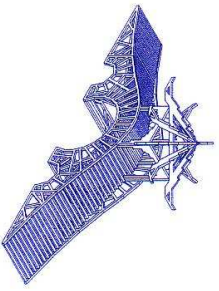
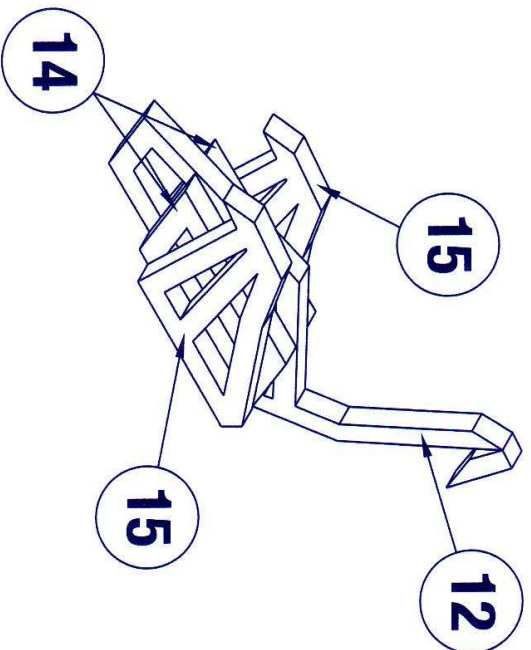

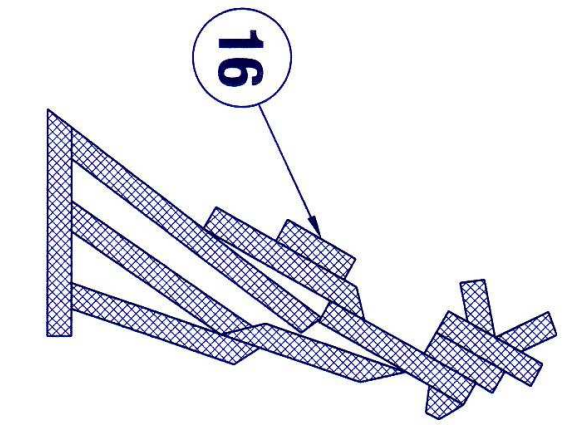

16

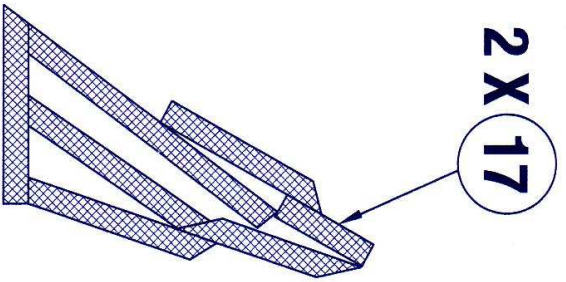

2 X 17

2 X 18

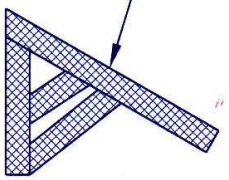

2 X 19



2 X 20

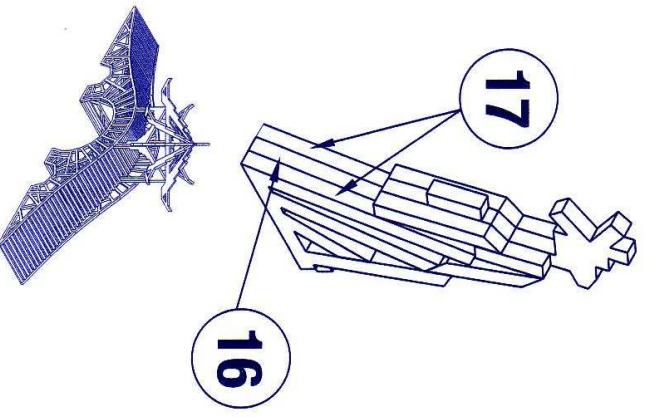

17

16

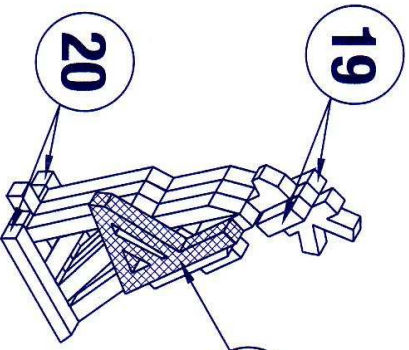

19

18

20

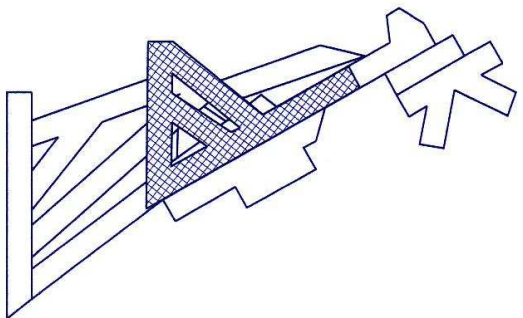
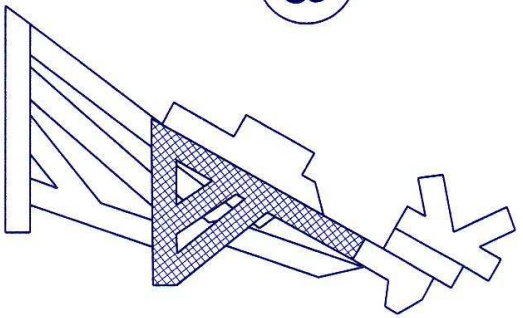

18

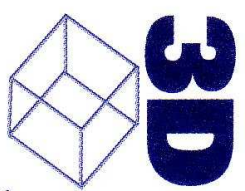

3D

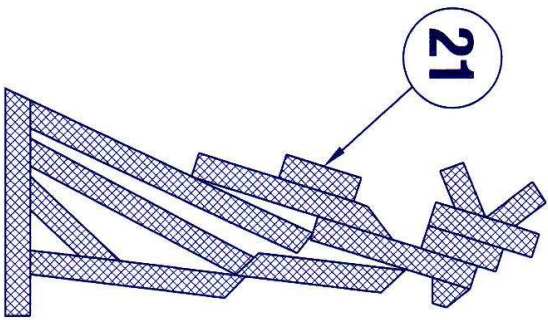

2 X 22

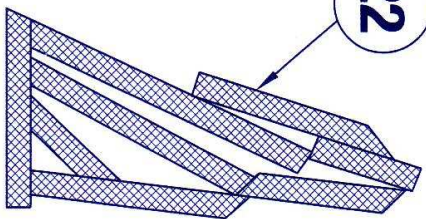

2 X 23

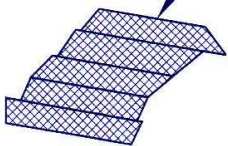

2 X 24



2 X 25



3D

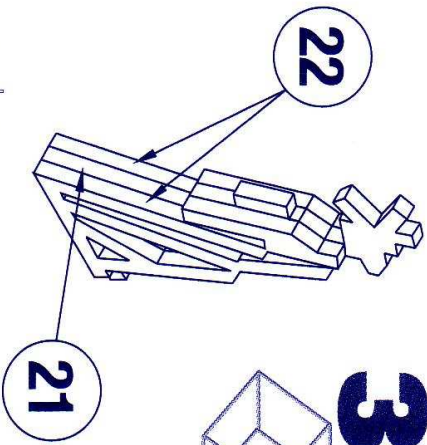
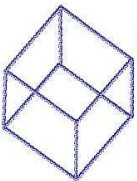

22

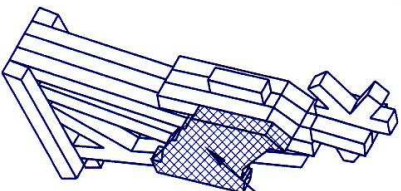

23

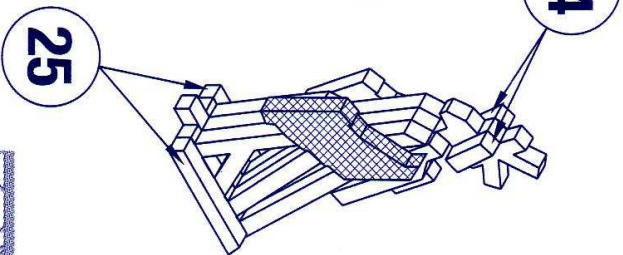

24

25

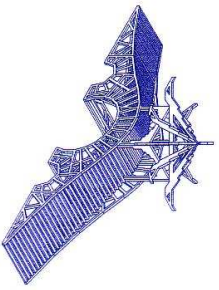
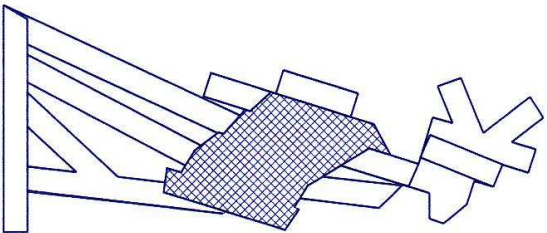

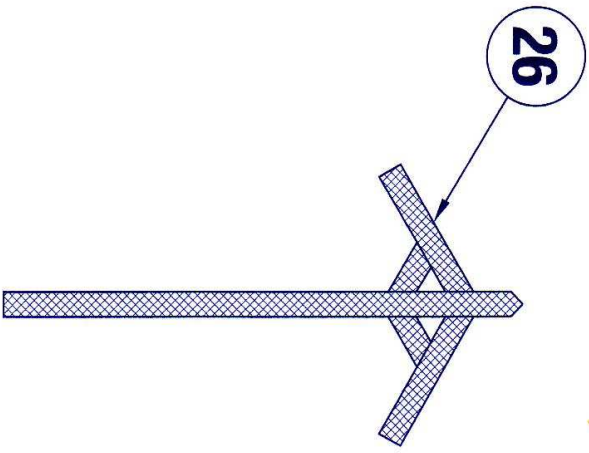

4 X 27

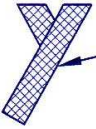

2 X 28

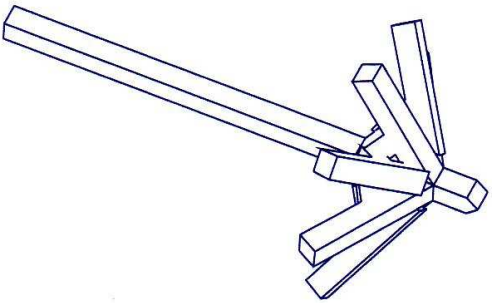
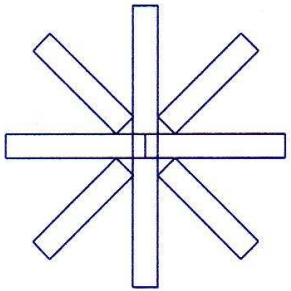
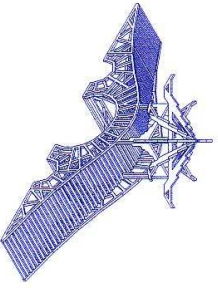
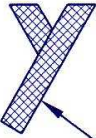

3D

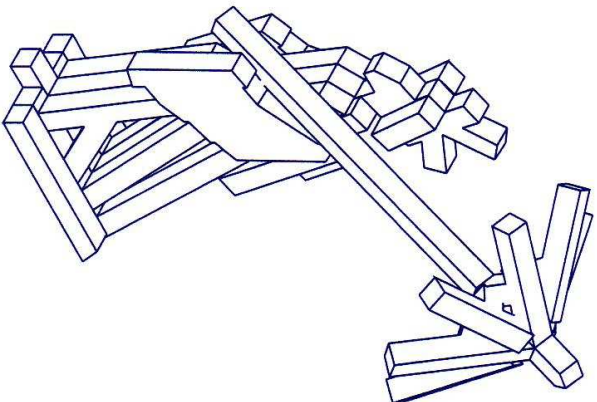
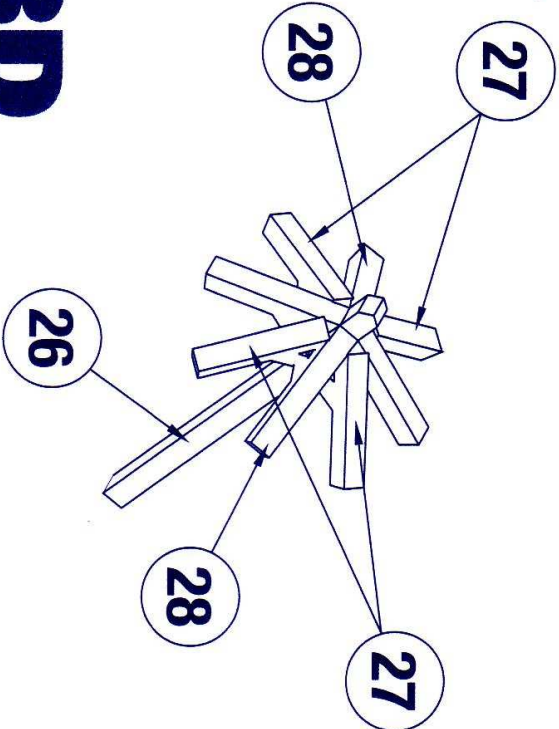
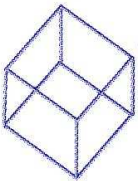

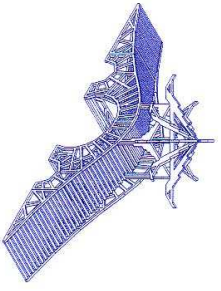

29

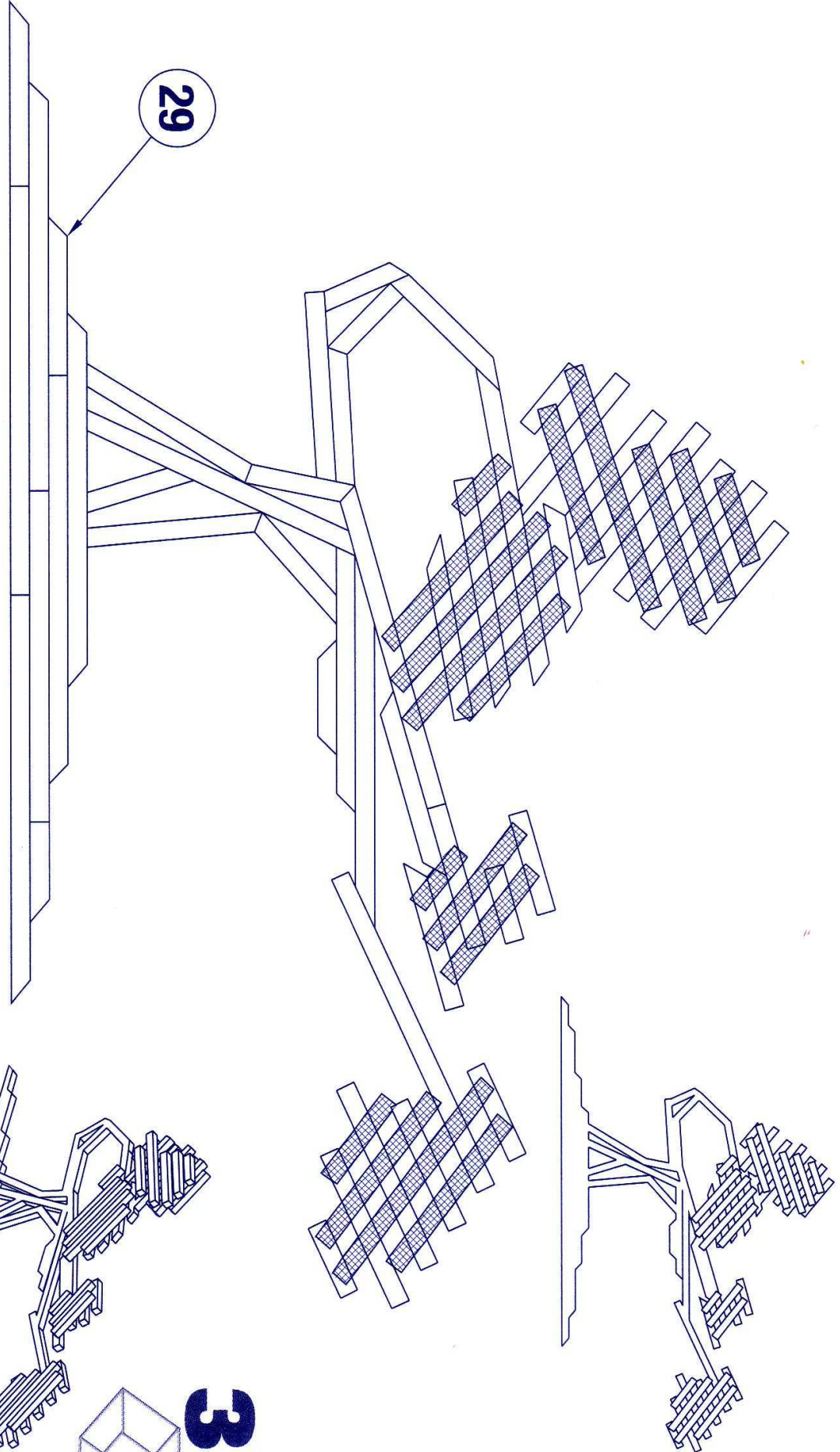

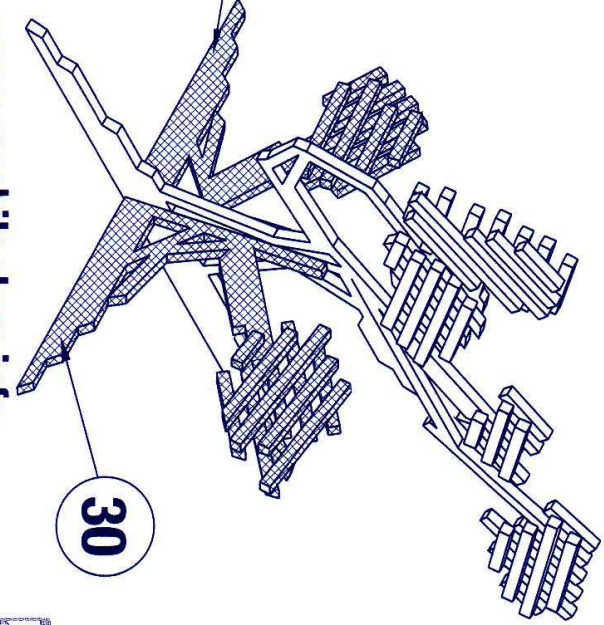
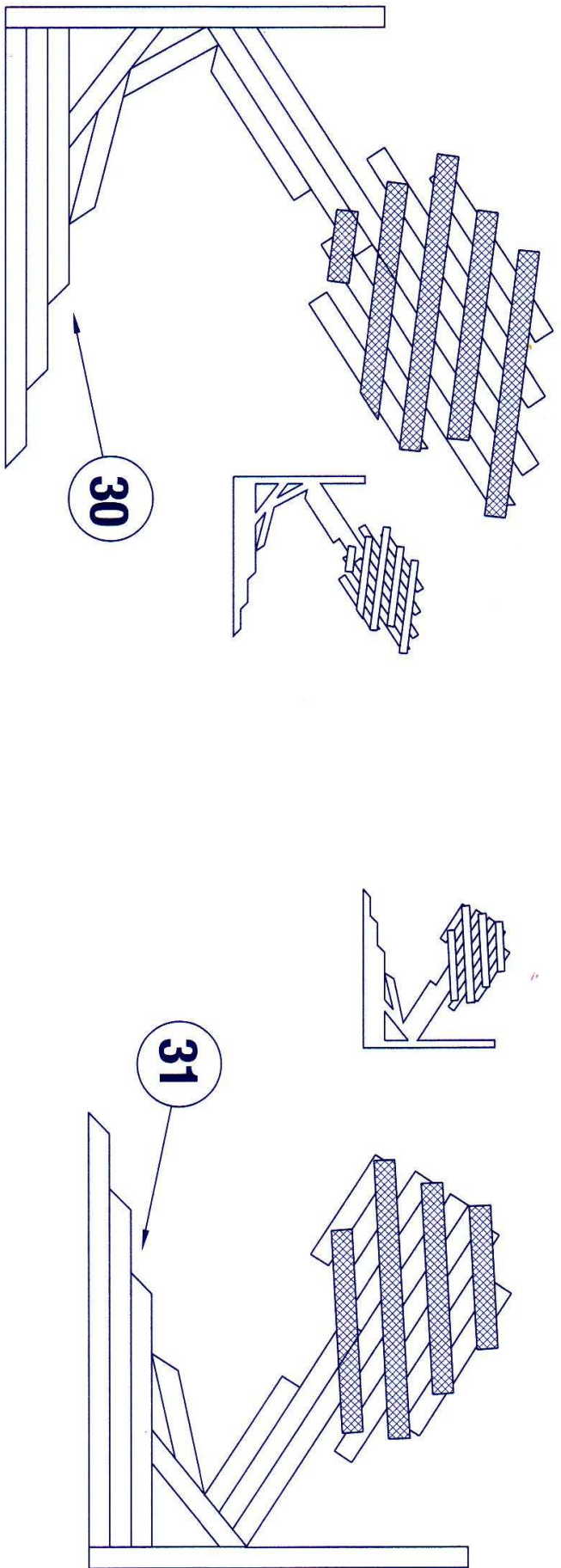

3D

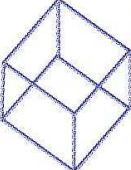
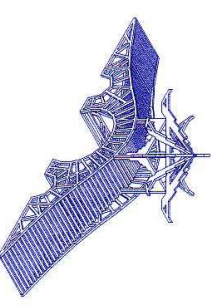
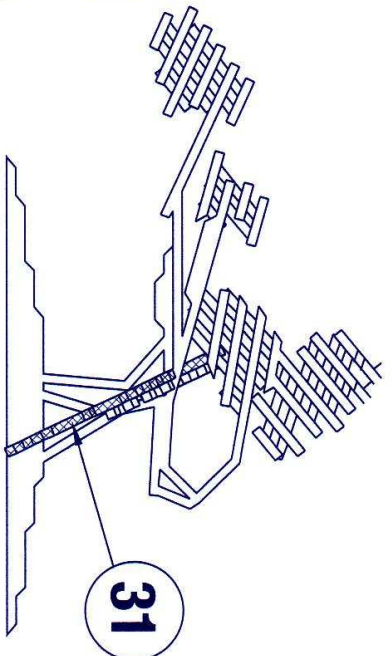

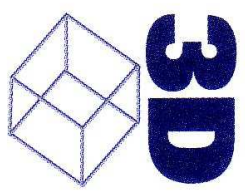
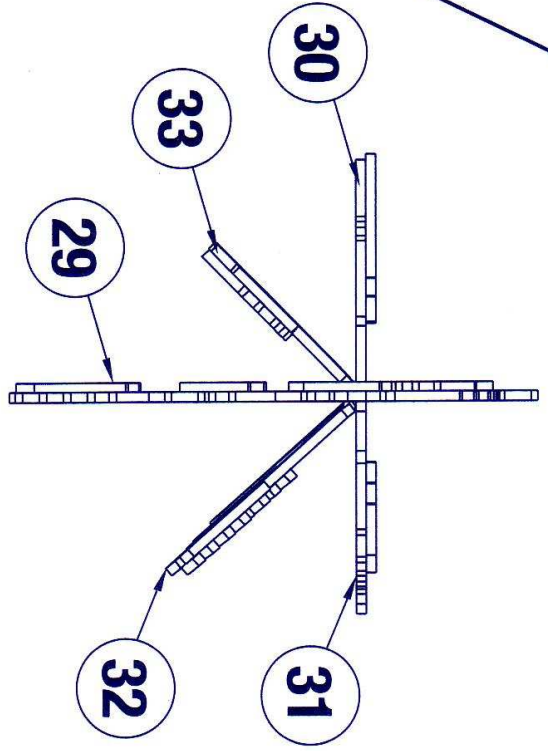
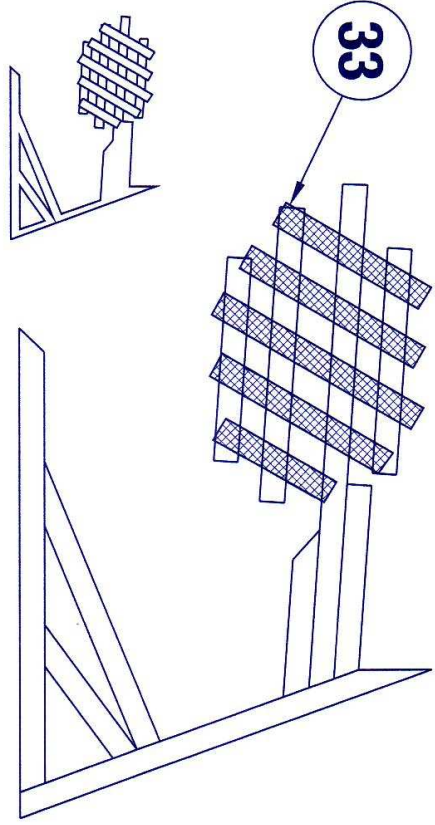
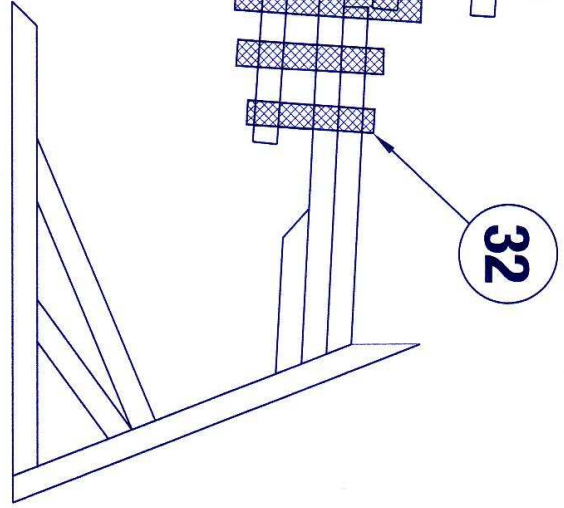
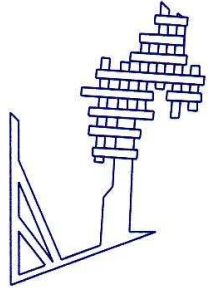
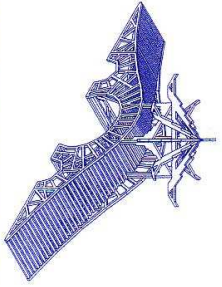

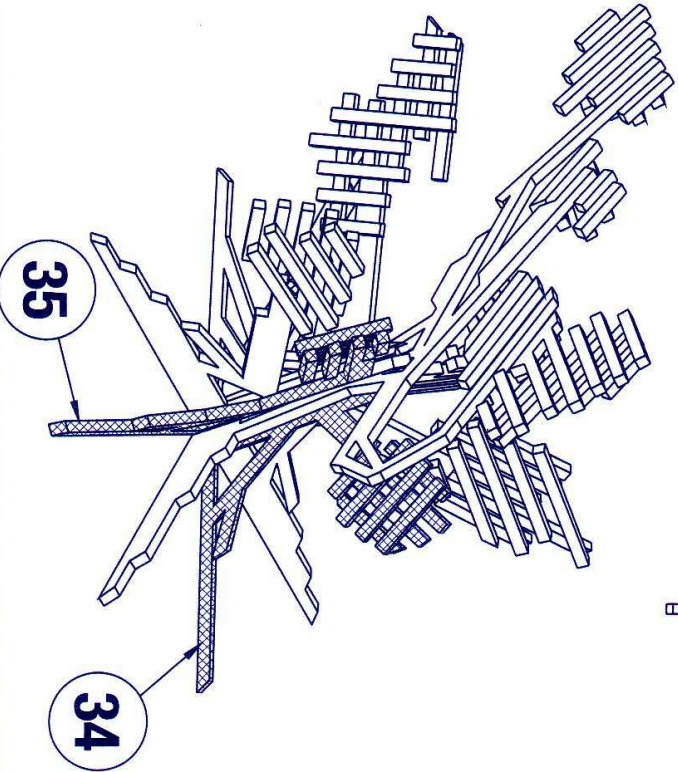
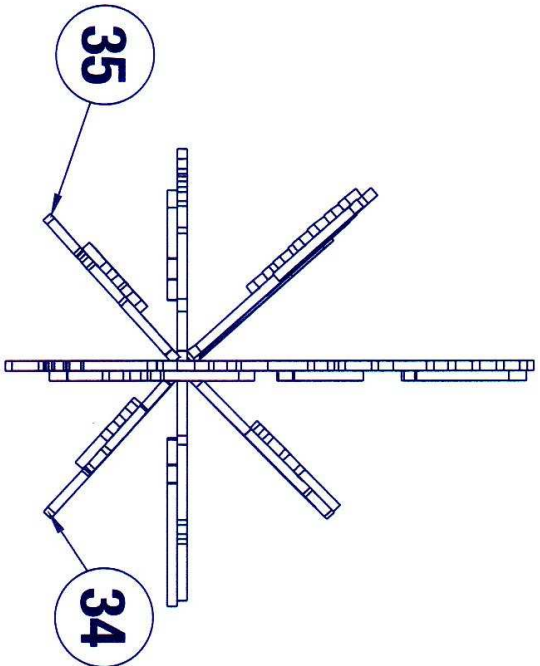

3D

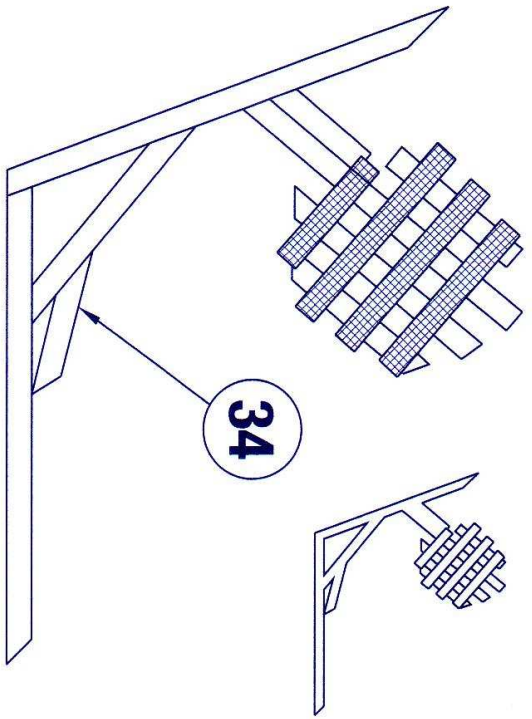

34



35

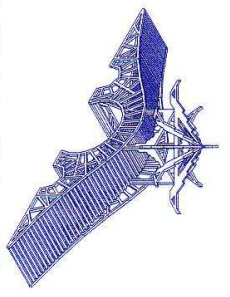
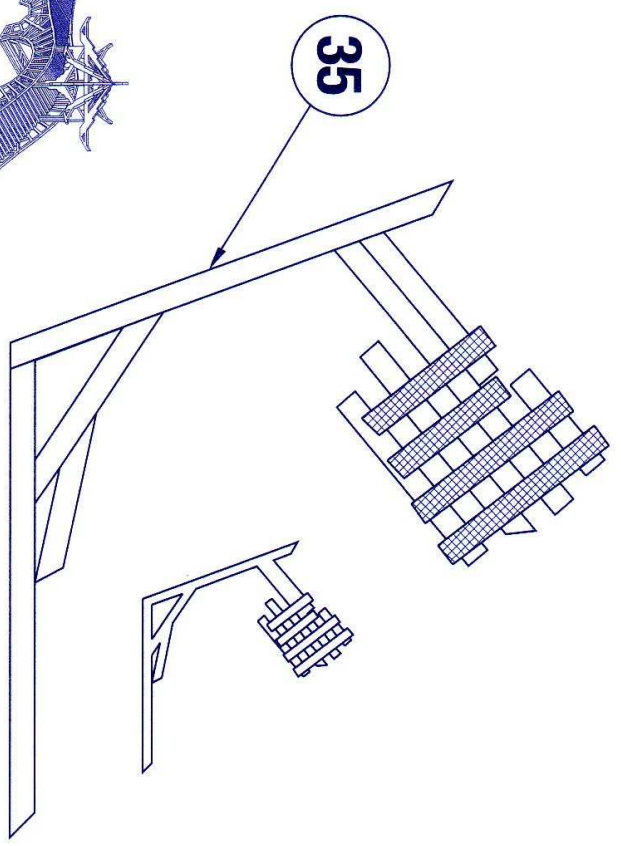

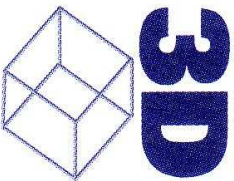
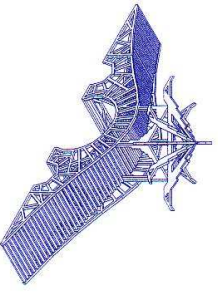
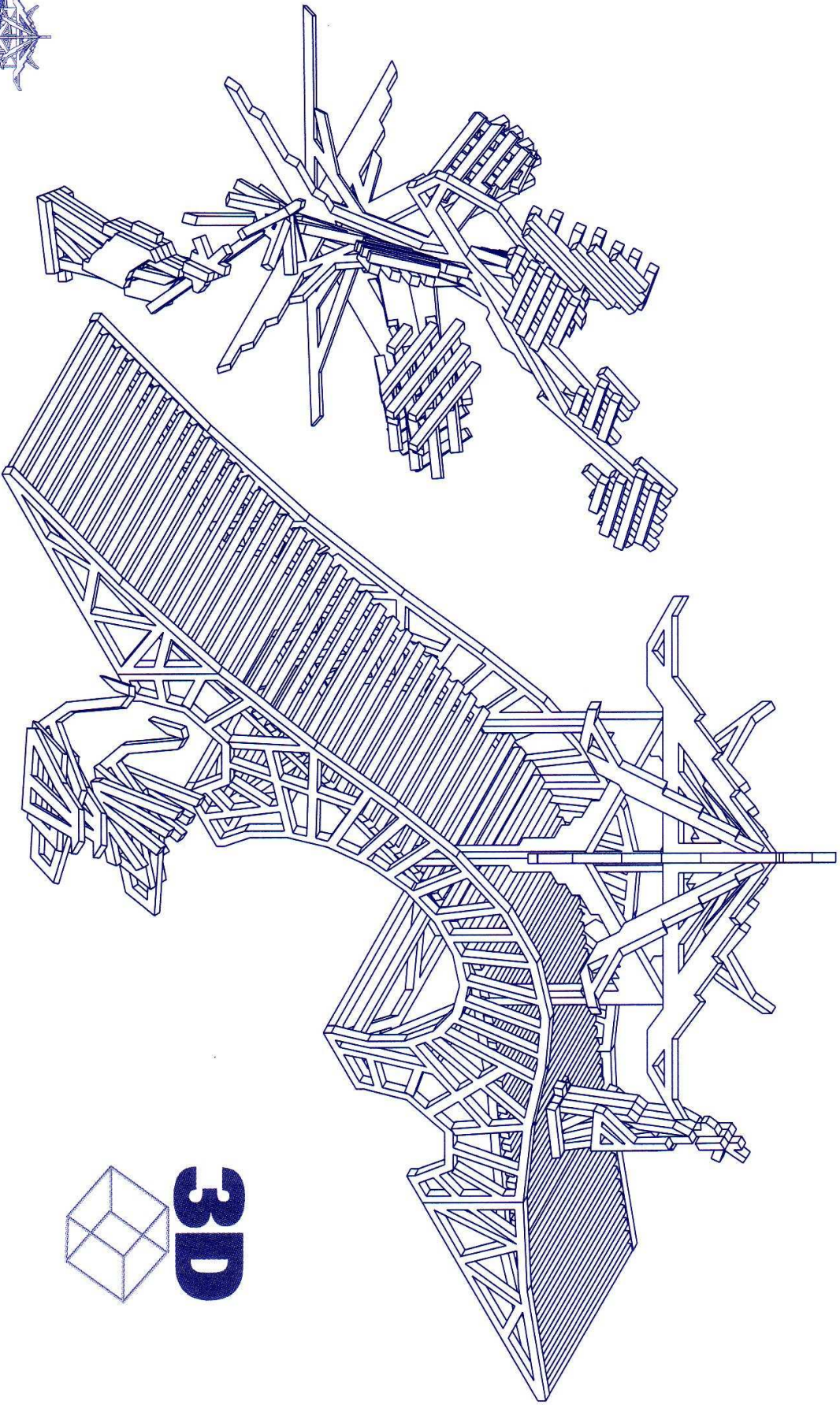

3D