



MA TECH ARCHITECTURE

MA TECH ARCHITECTURE

The Ultimate Building Passion
L'ultime passion de construire
La pasión suprema de construir



MICRODEAM cutter • Coupe-MICRODAMBIER
• БоралличРОВИЧ

Mechanical Digger
Pelle mécanique
Pala mecánica



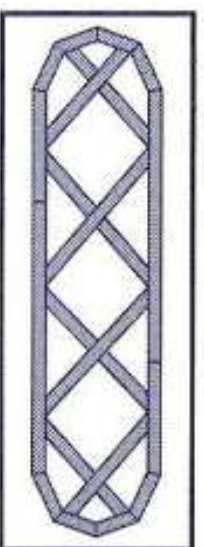
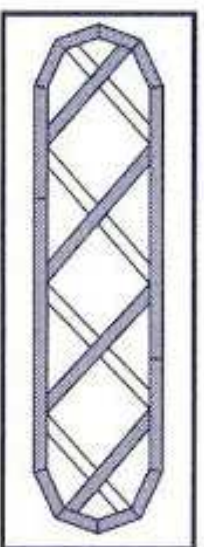
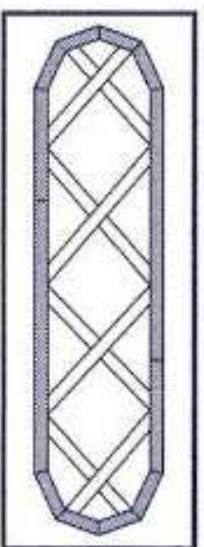

8 X 1

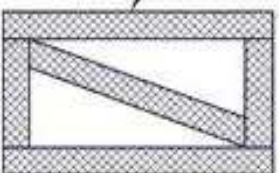

80 X 2



4 X 3

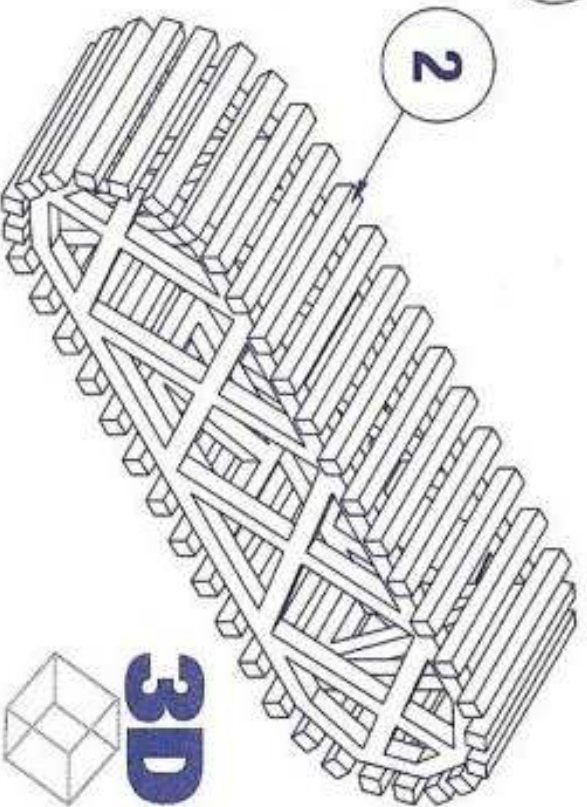
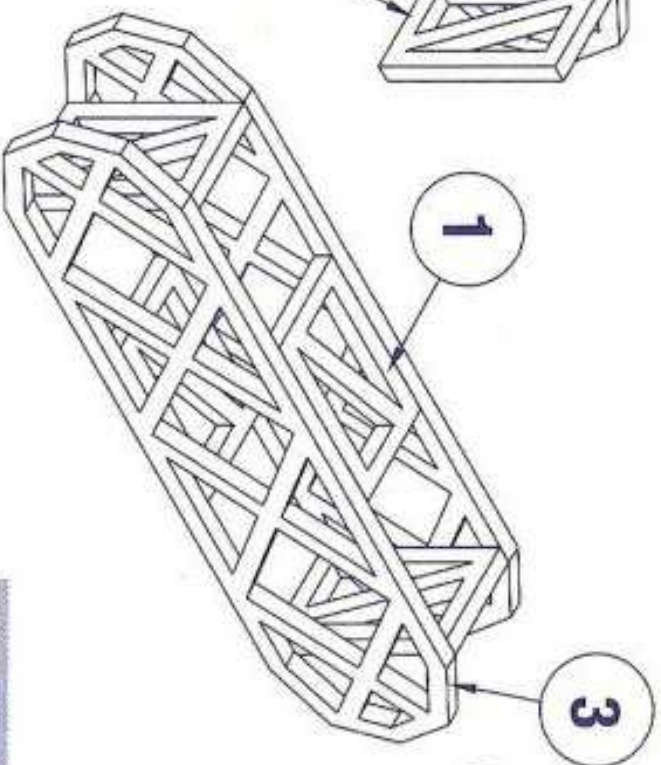
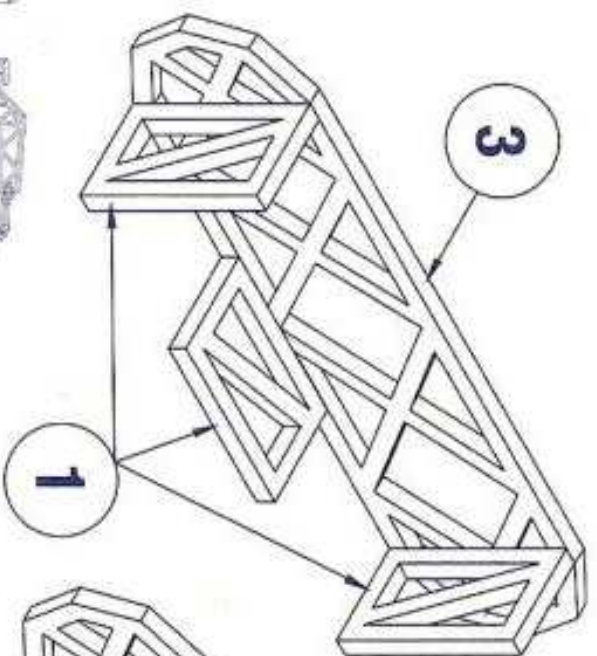
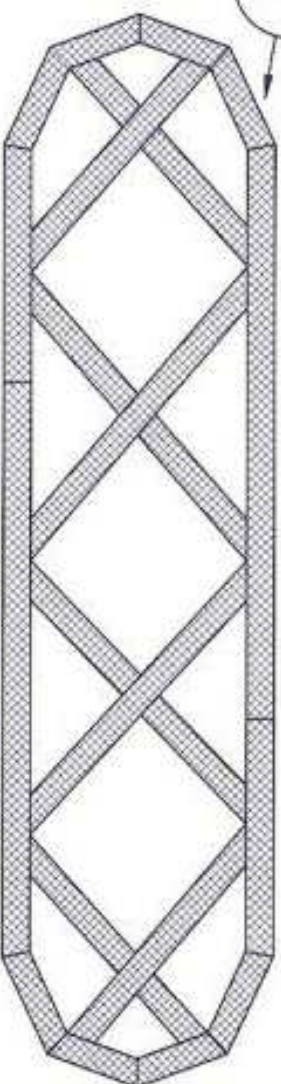

3D

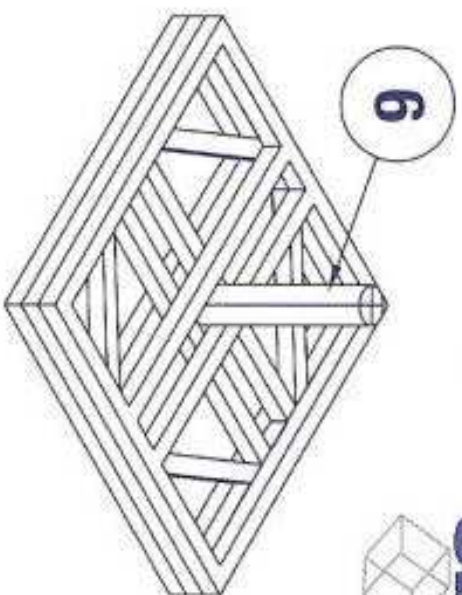
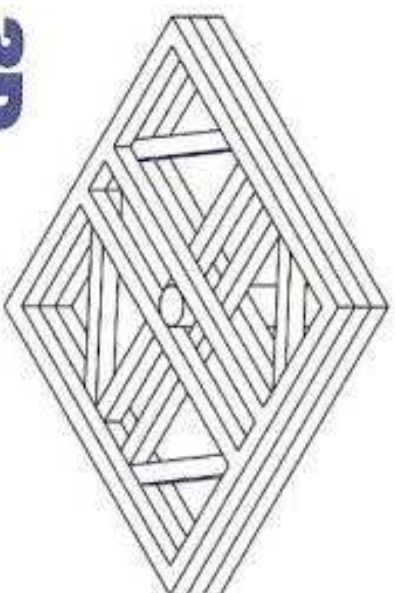
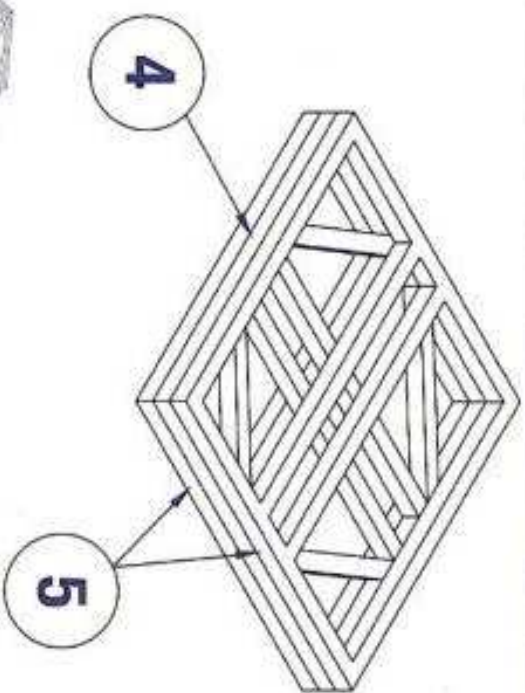
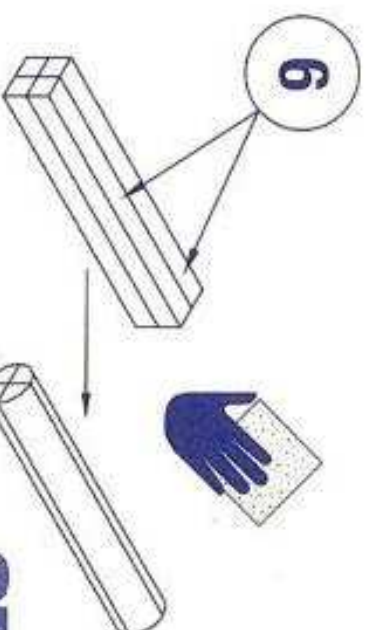
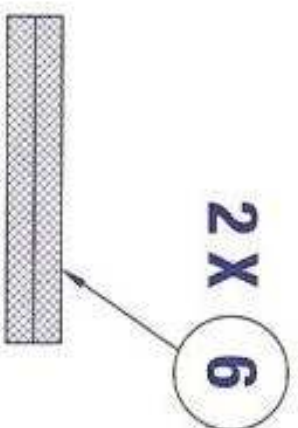
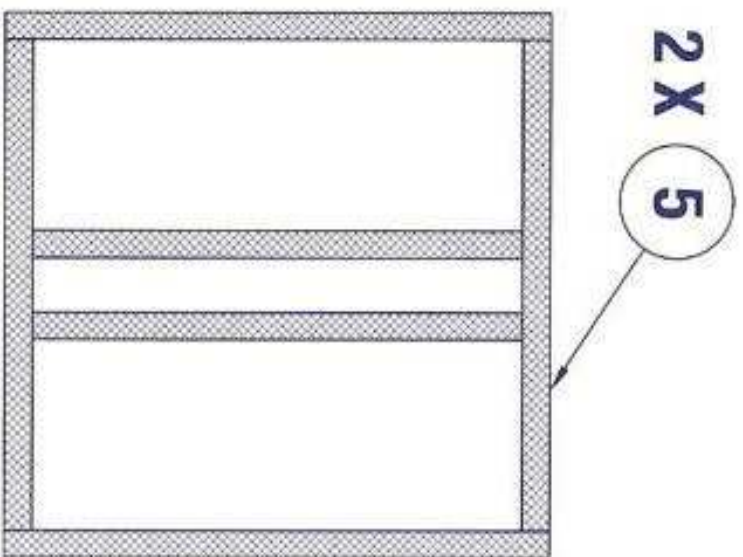
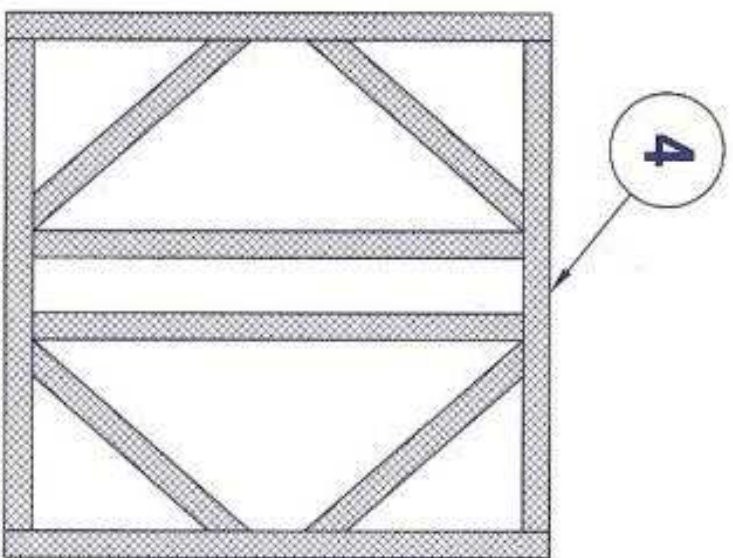

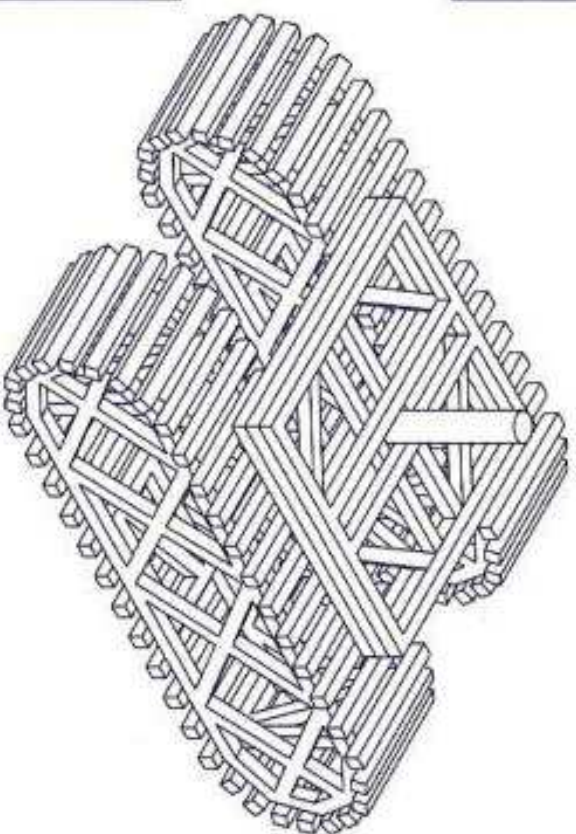
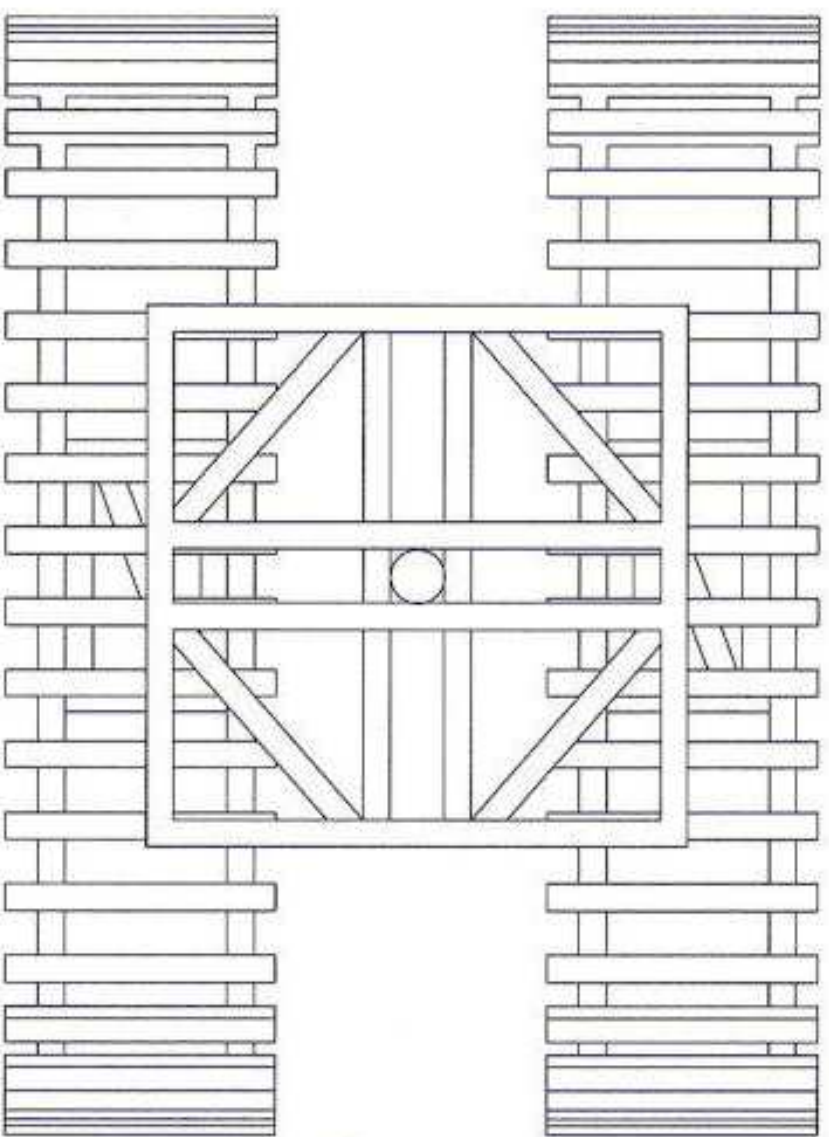

3D



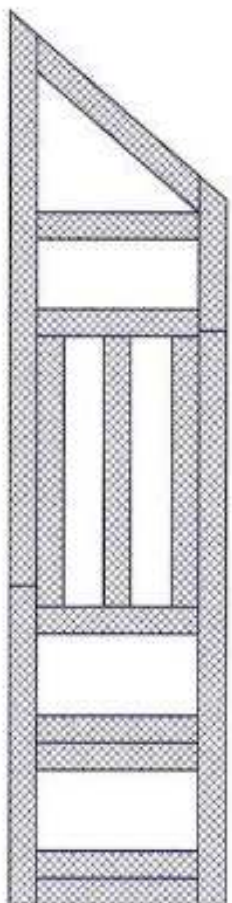

7

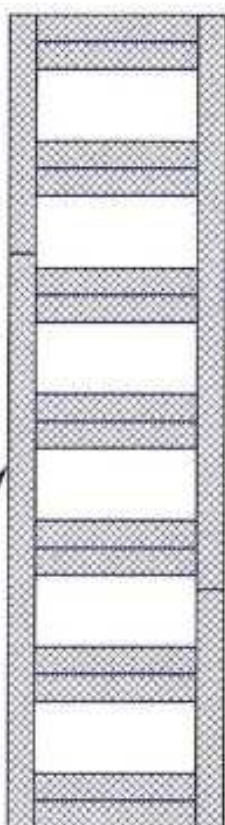

10

9

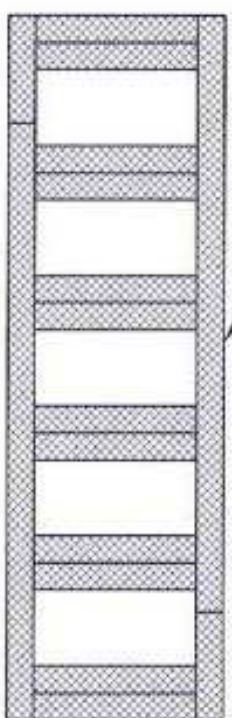

4 X 11

4 X 12

8 X 13

8

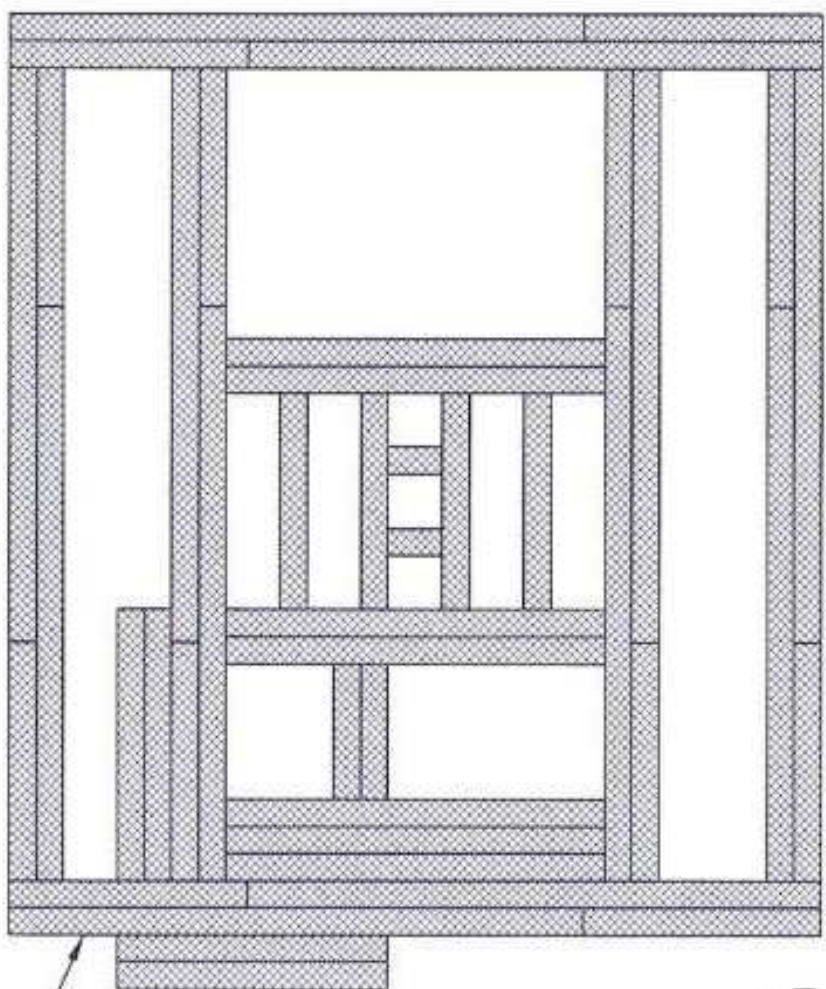

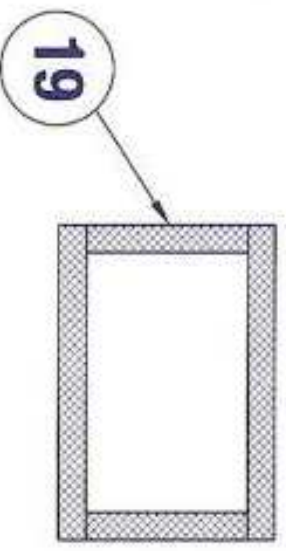
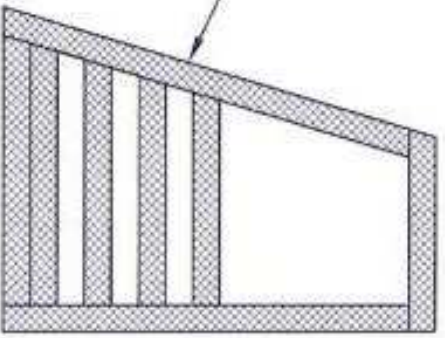
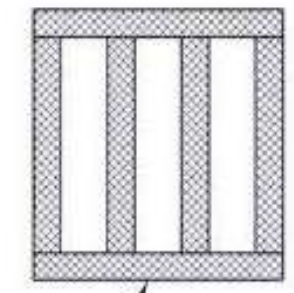
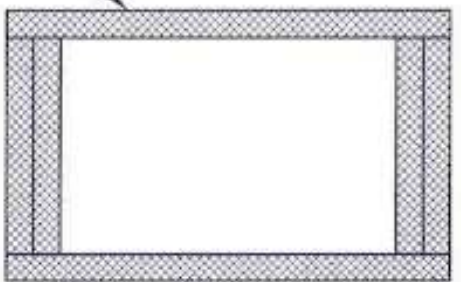
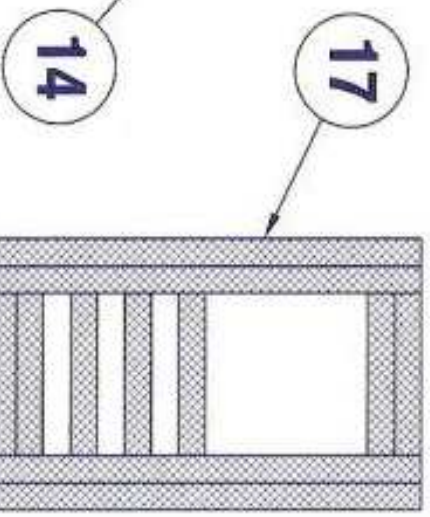
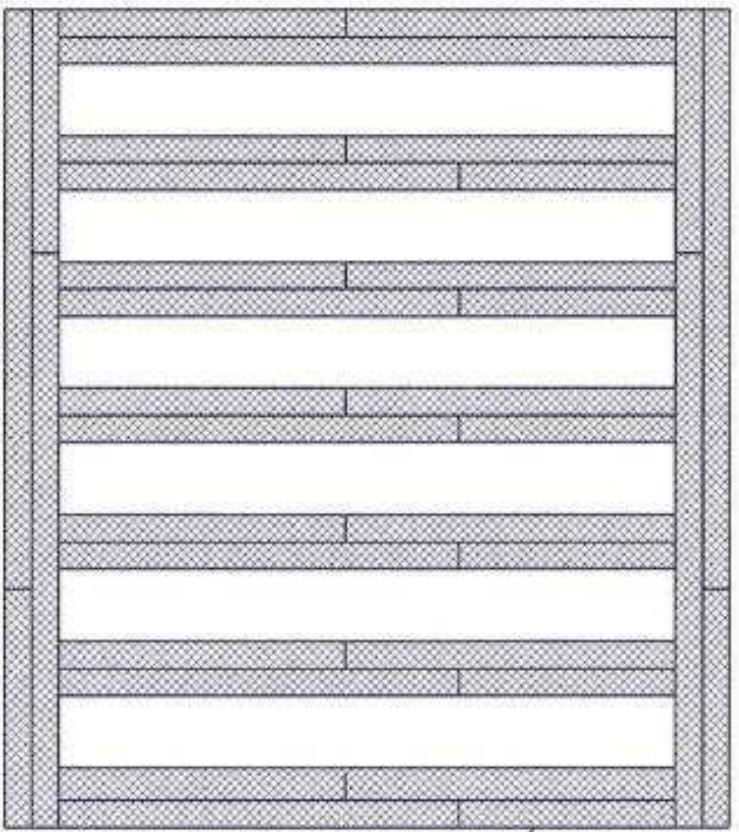

2 X 16

15

16

14

17

18

19



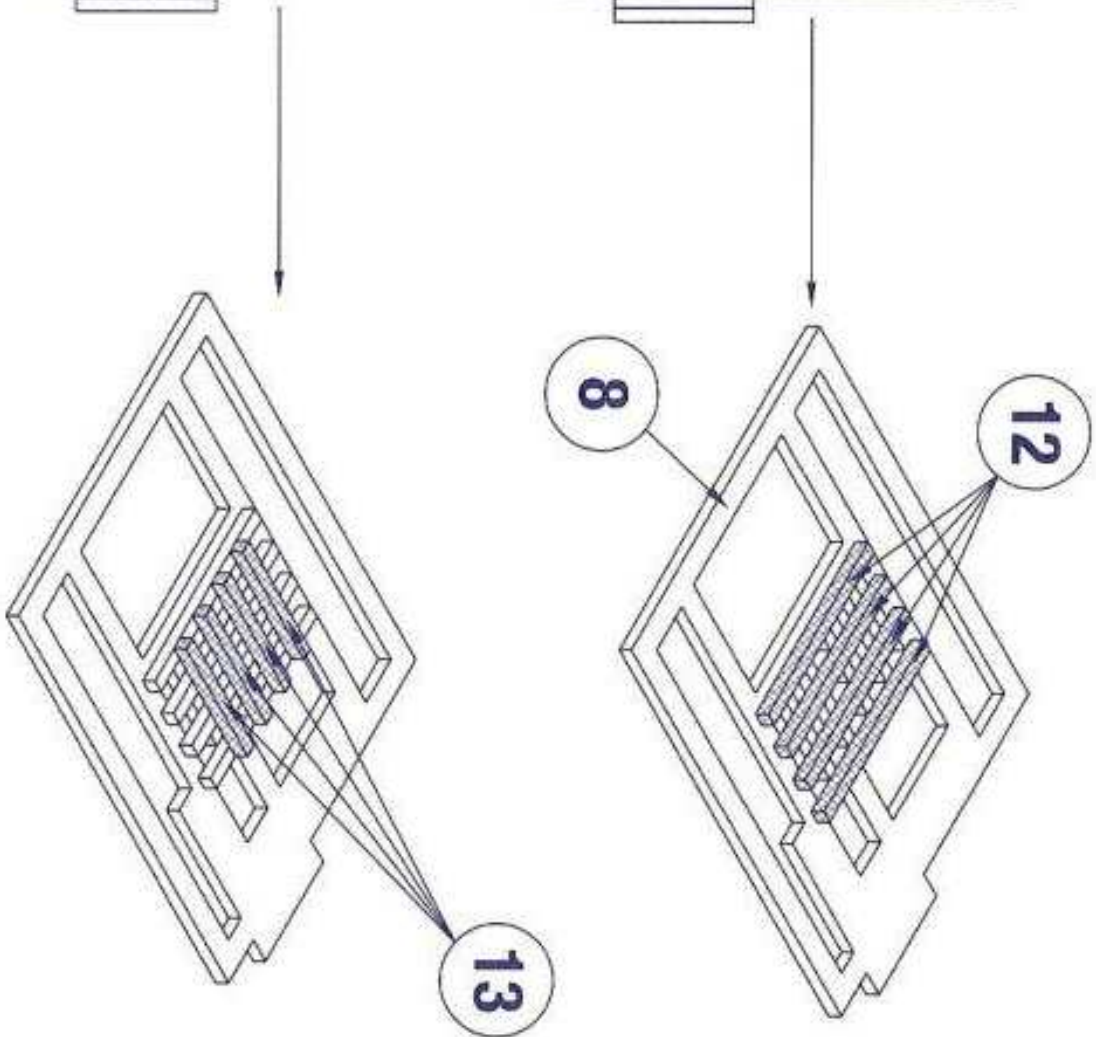
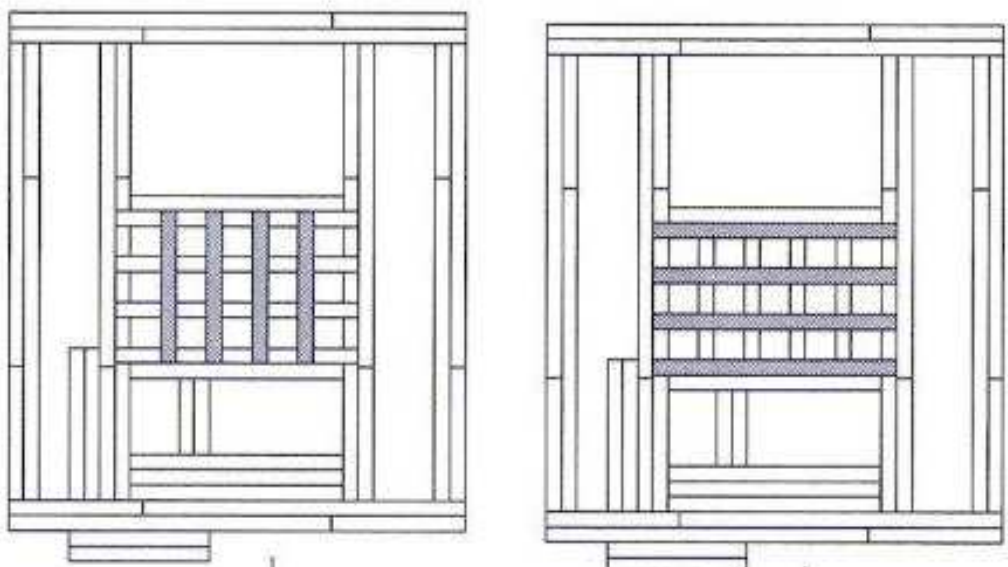

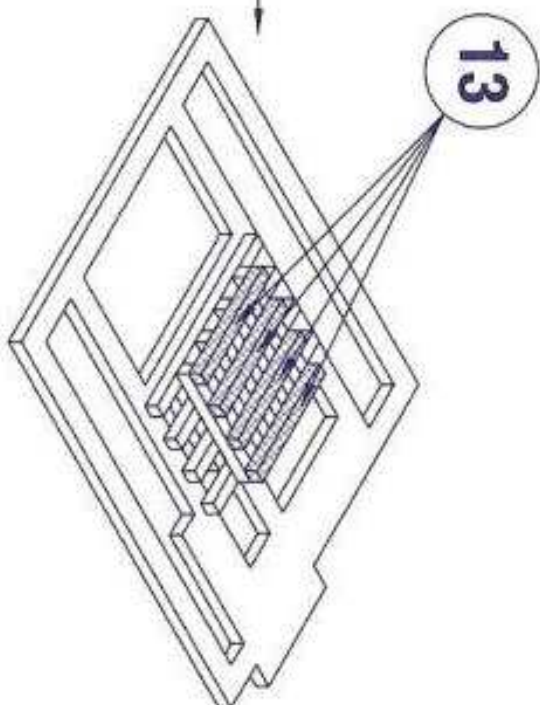
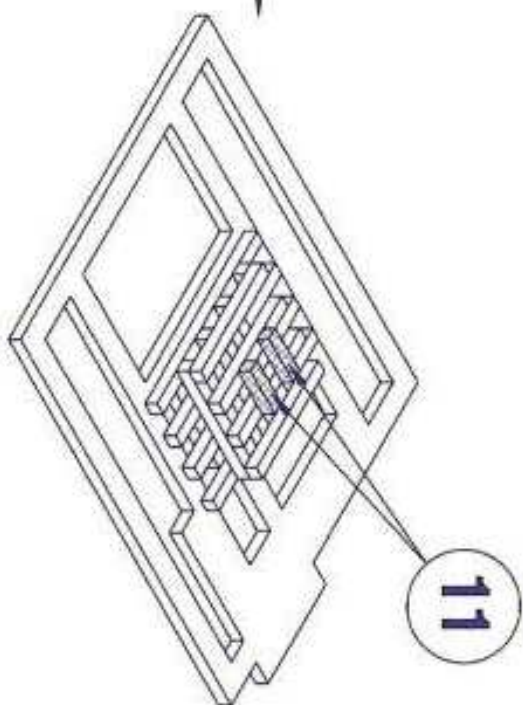
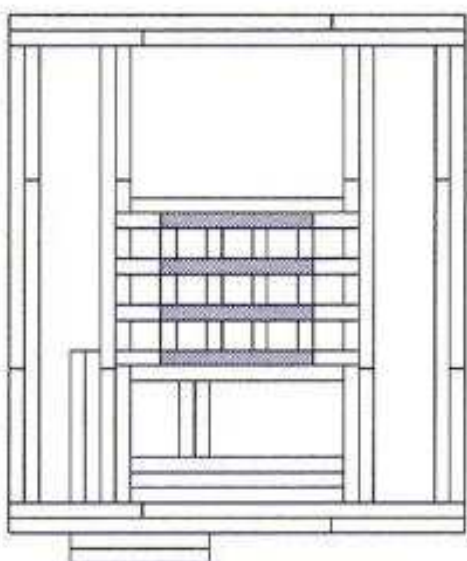
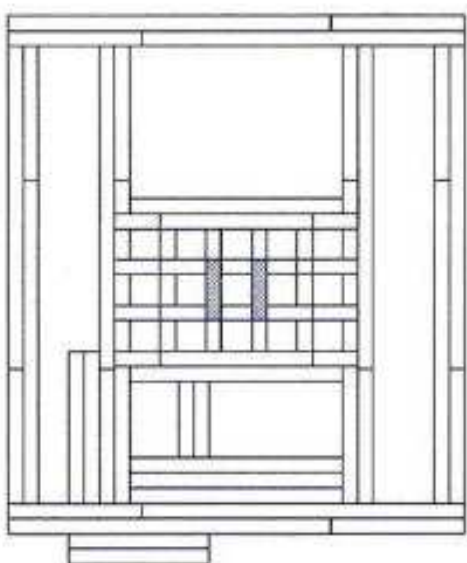

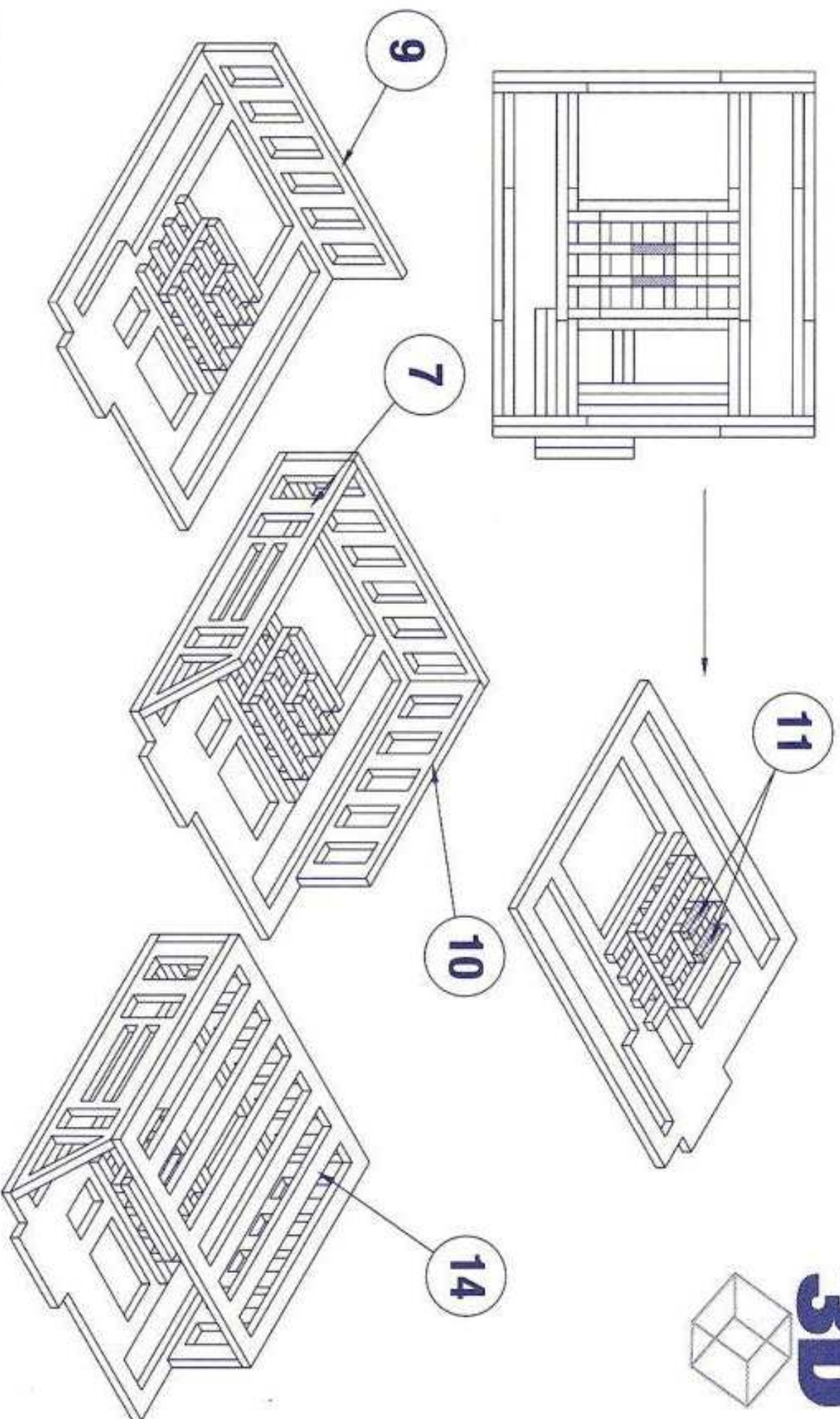

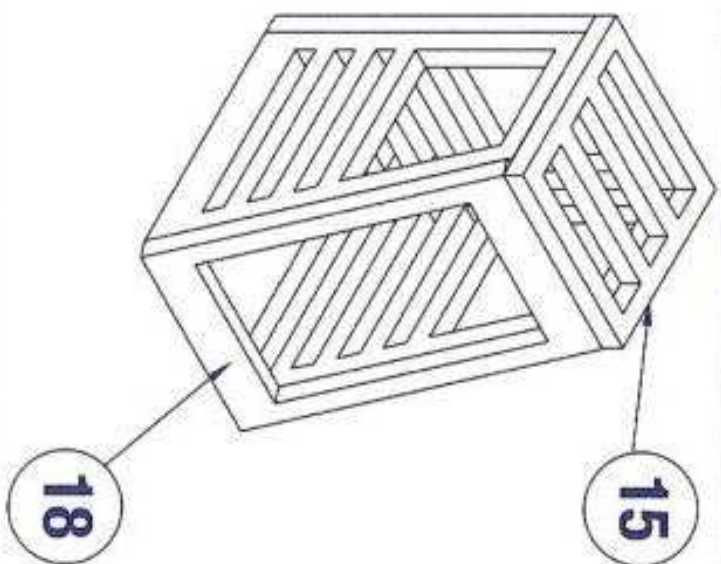
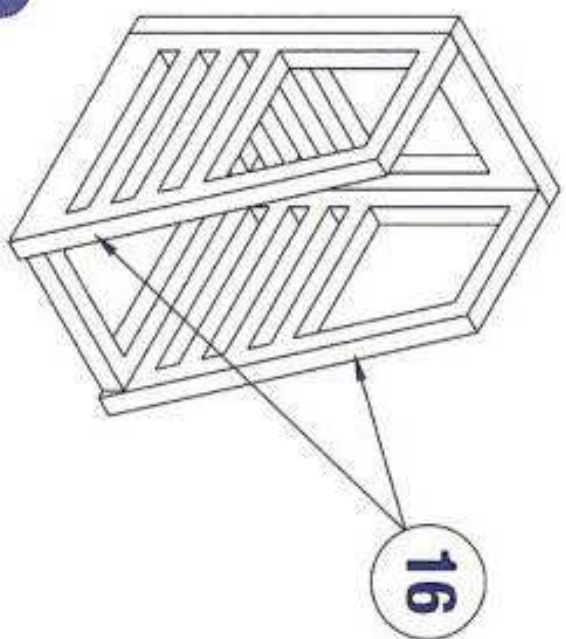
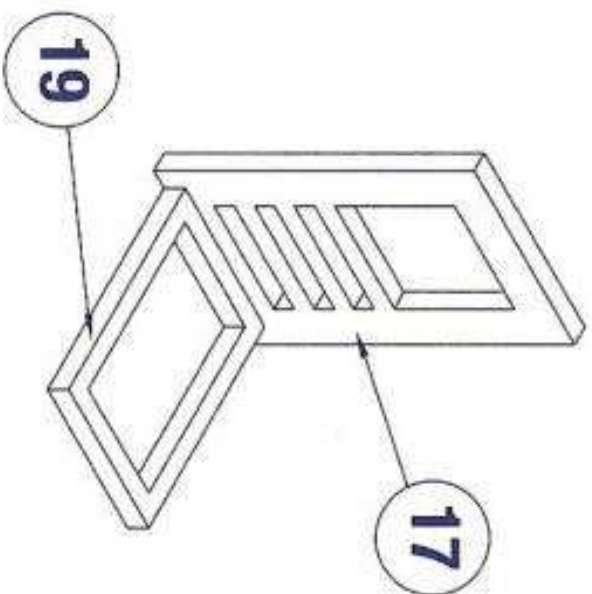
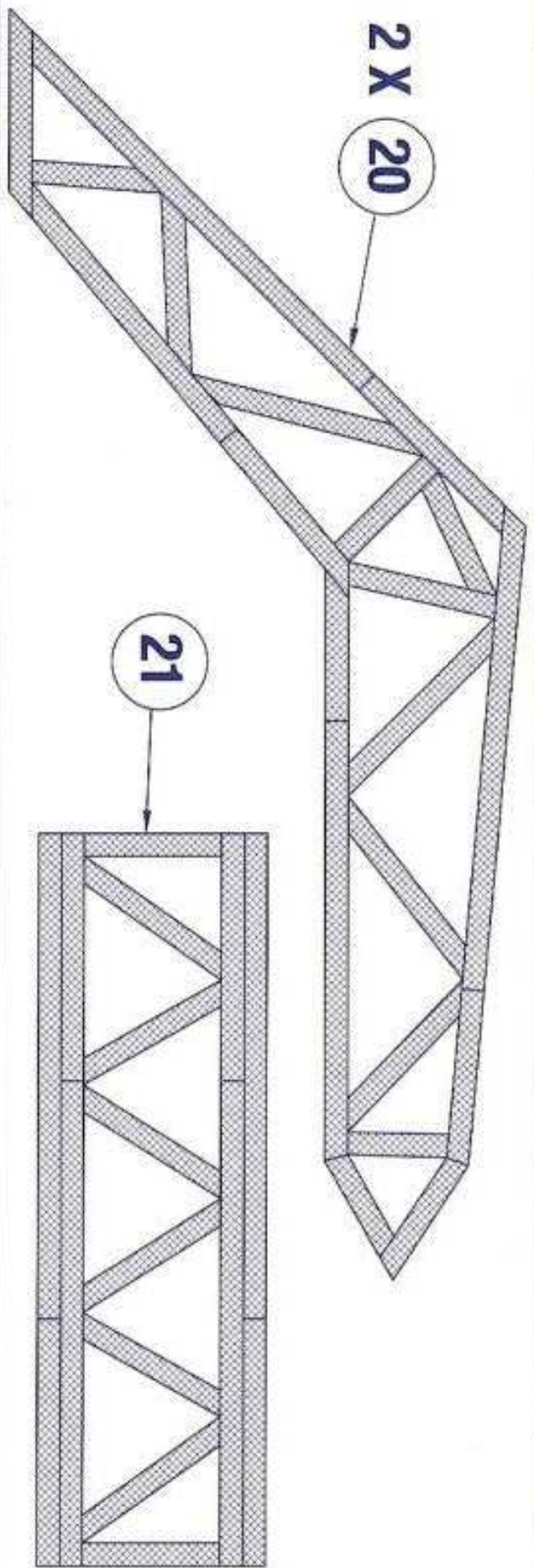

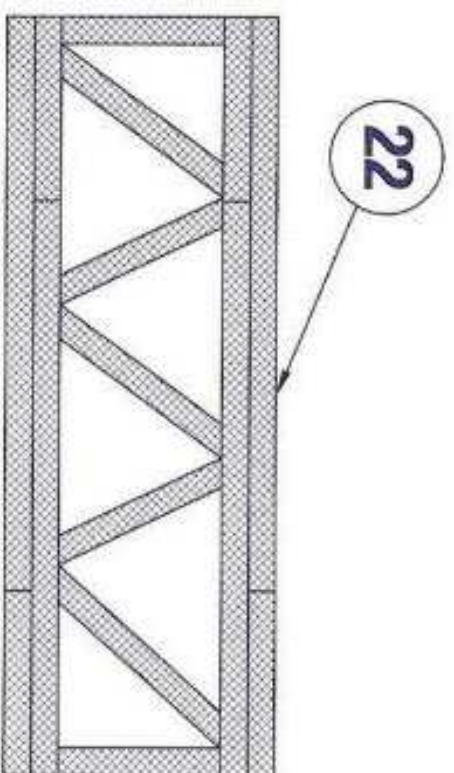

2 X 26

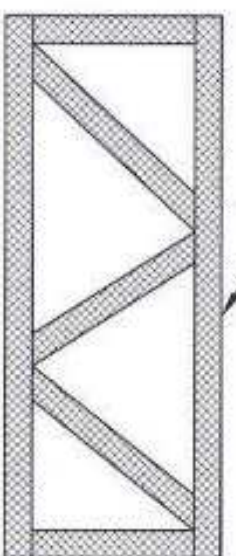
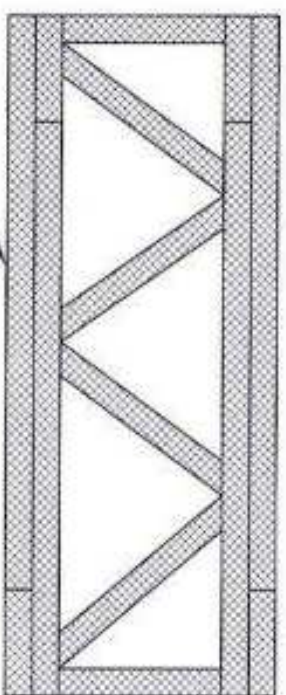
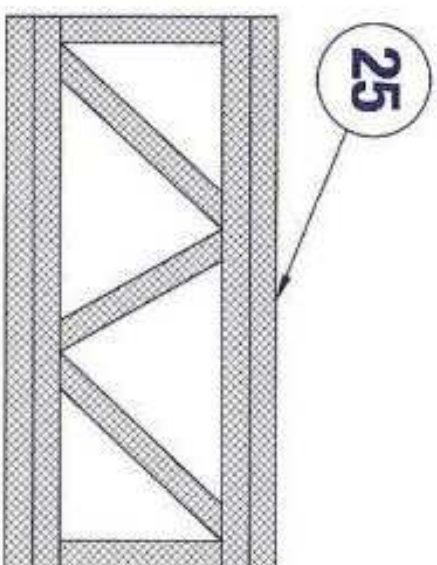

5 X 27

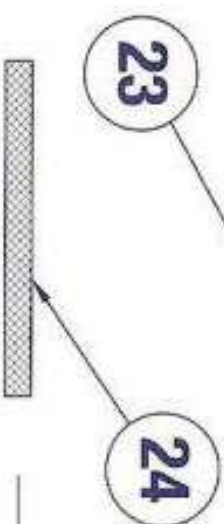

2 X 28



3D



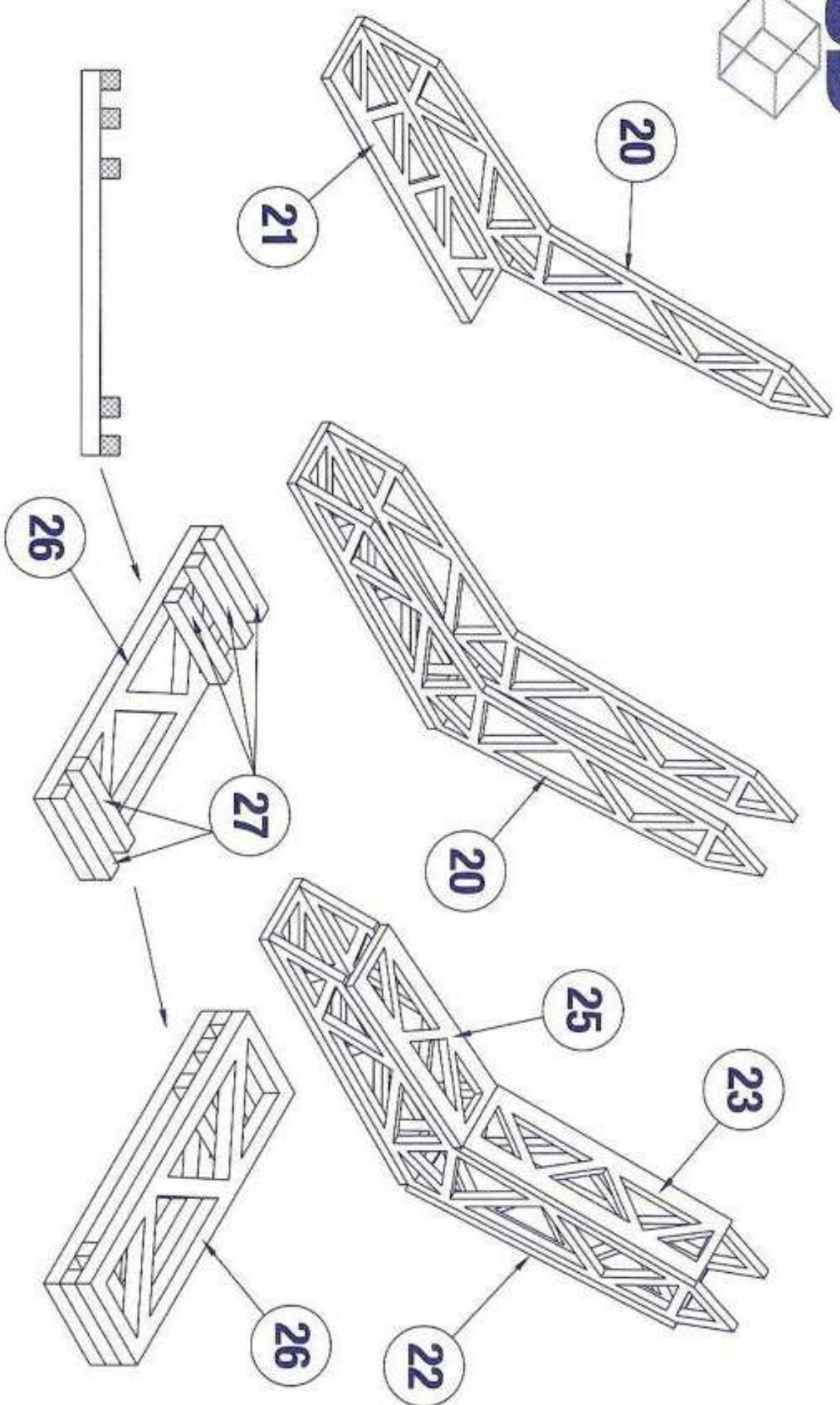

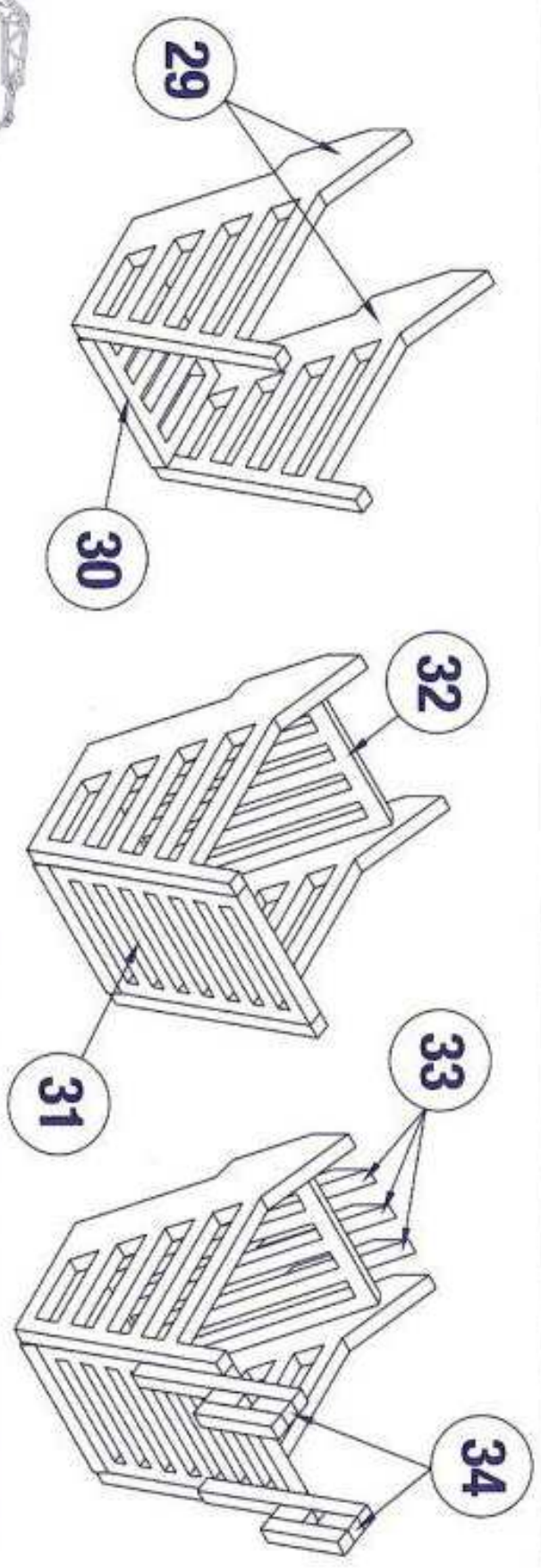
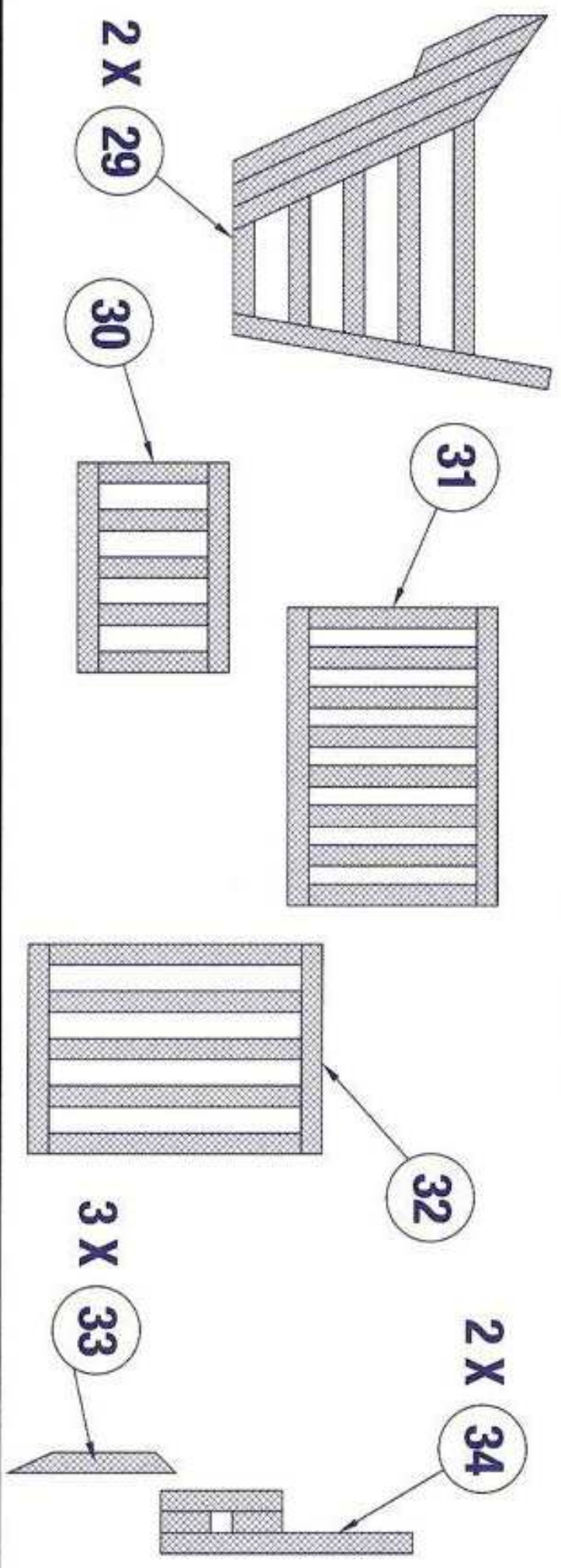

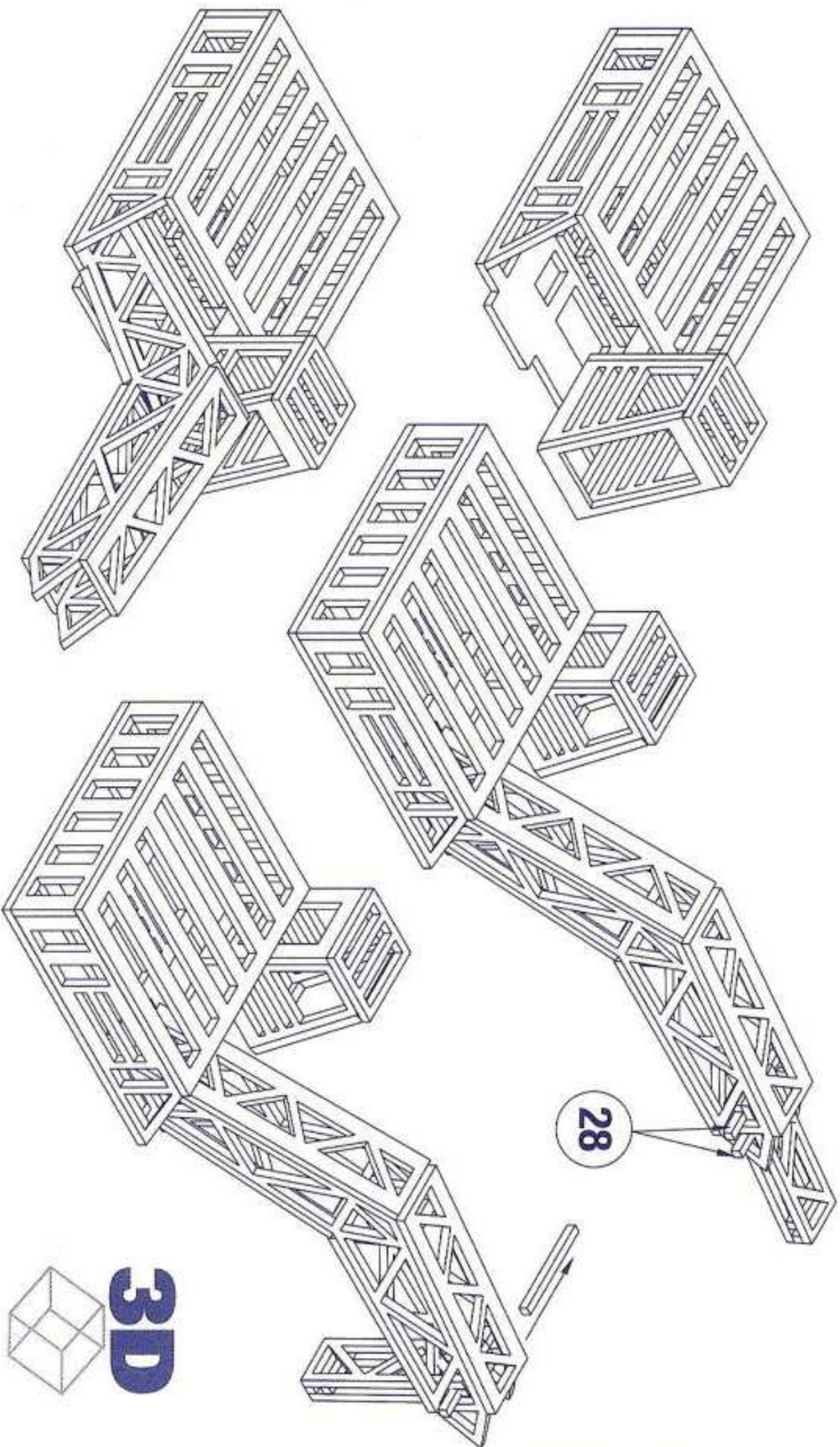

28

3D



© 2002 Jouets Bô-Jeux toys inc.

www.machitecture.info

MACHITECTURE

13 / 22

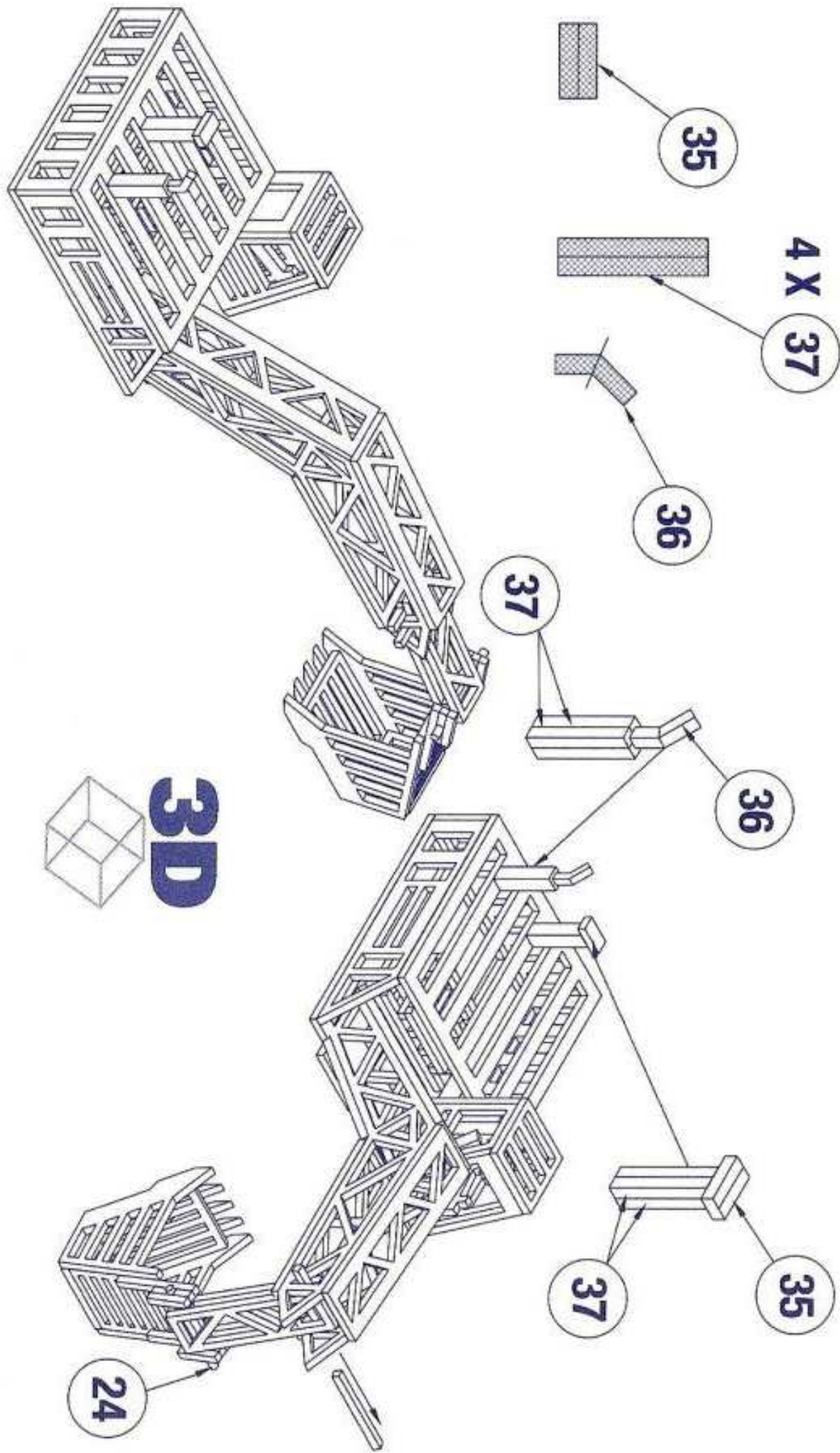

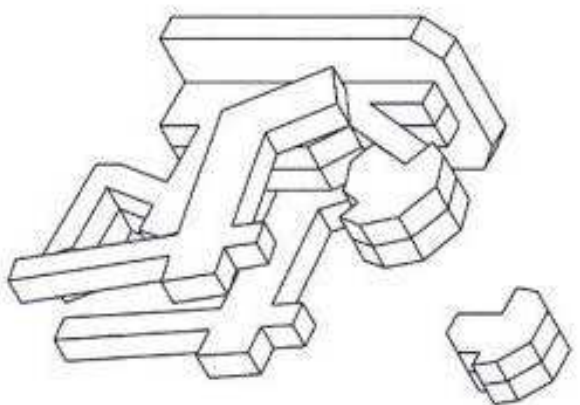
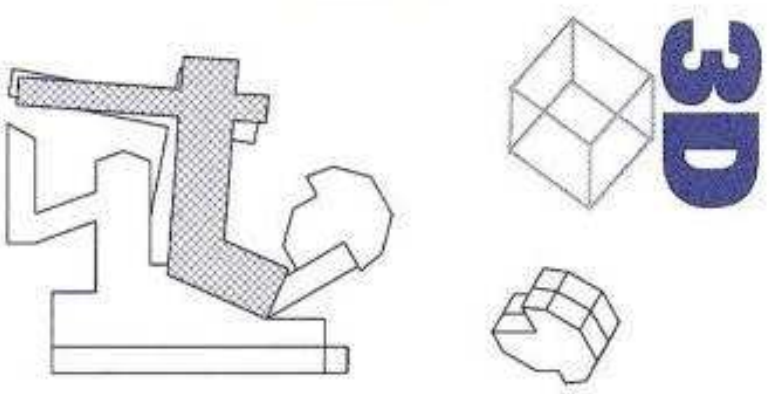
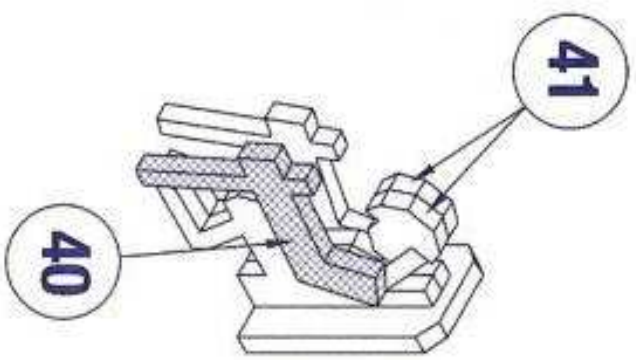
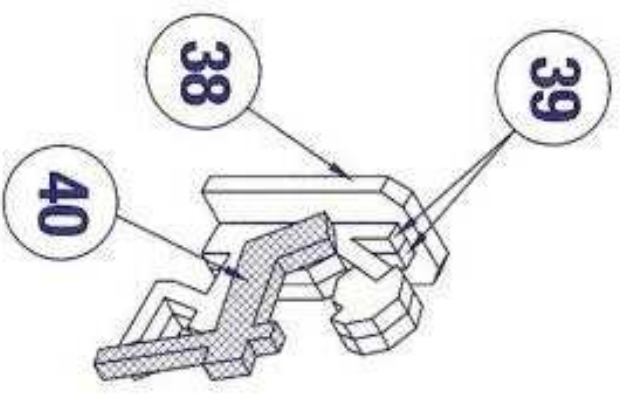
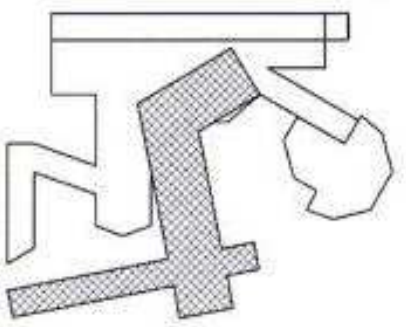
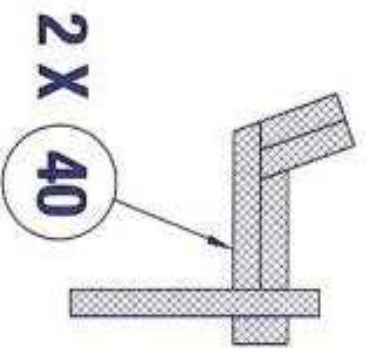
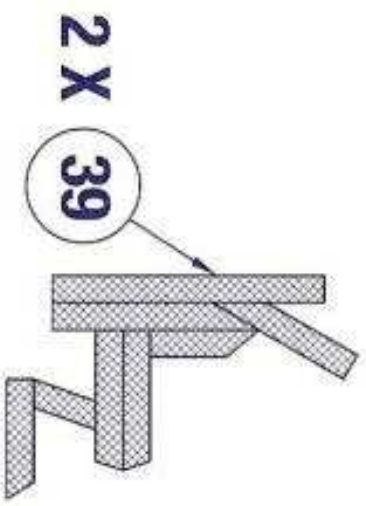
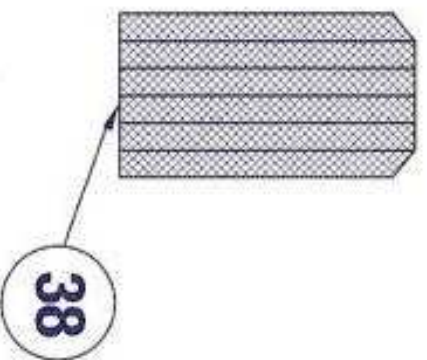

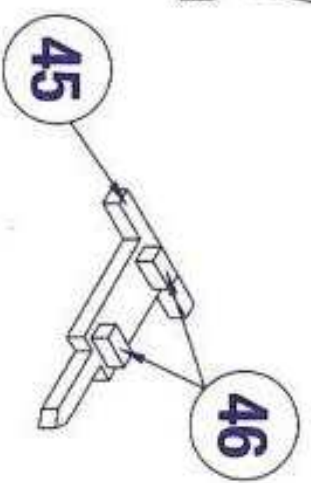
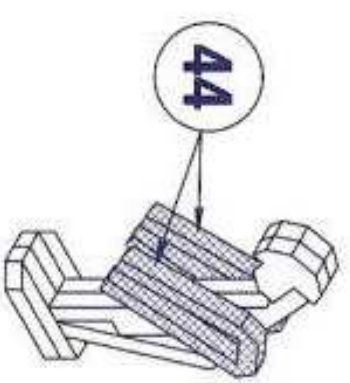
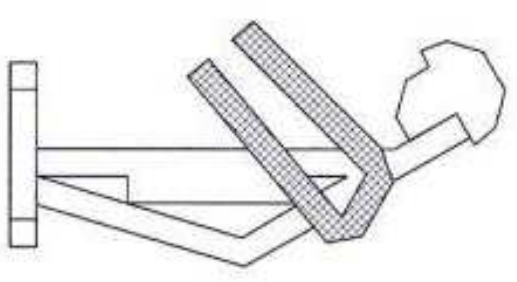
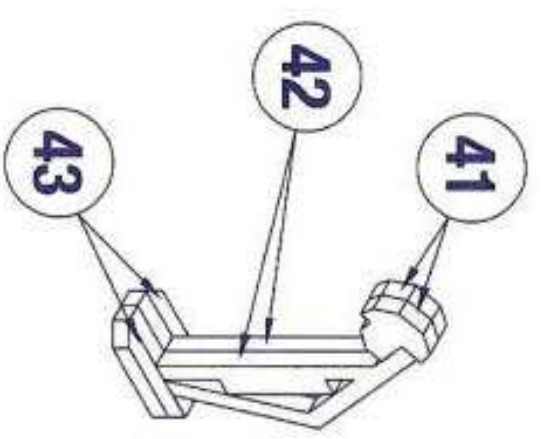
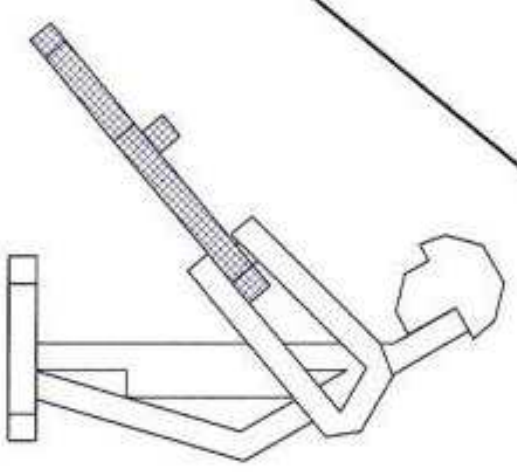
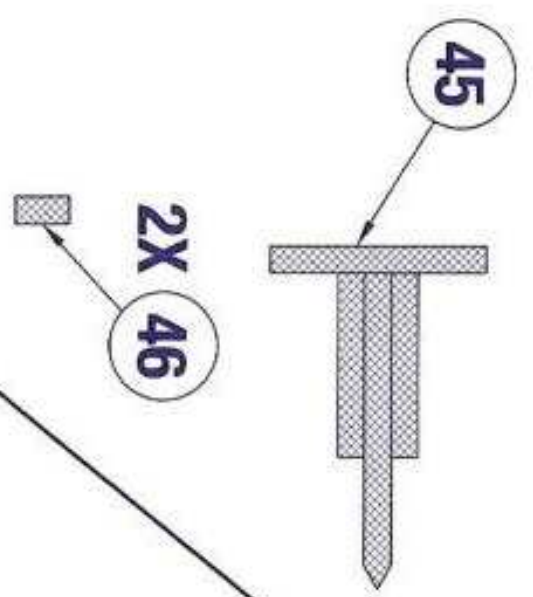
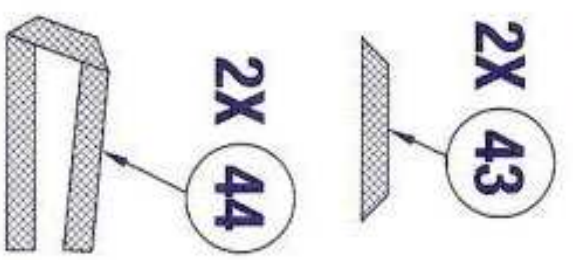
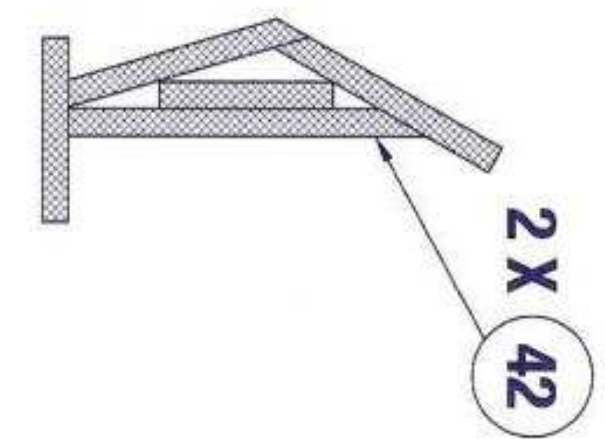

3D

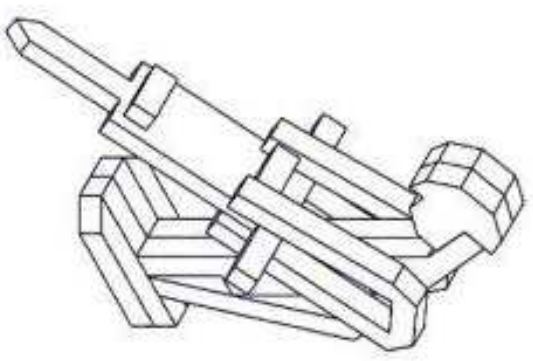

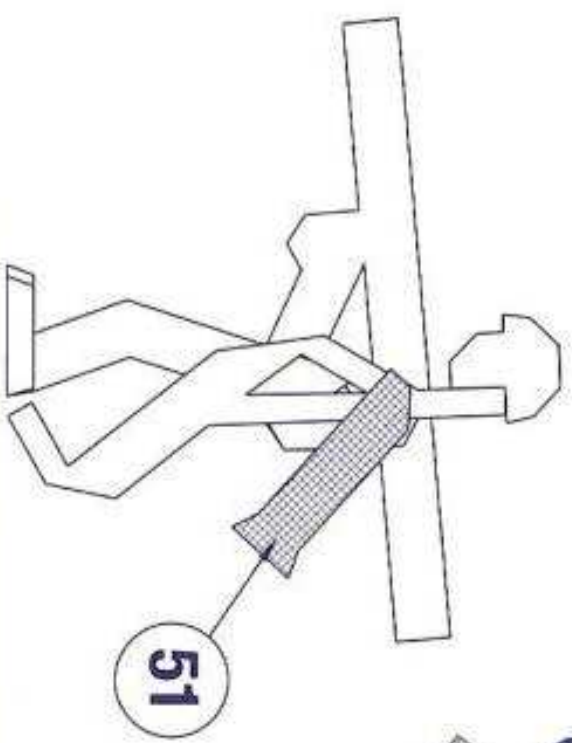
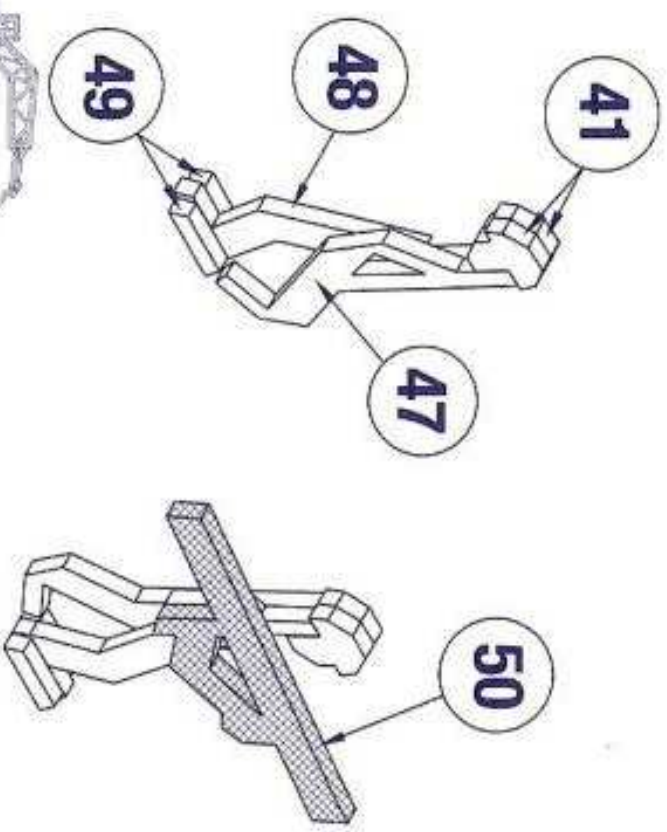
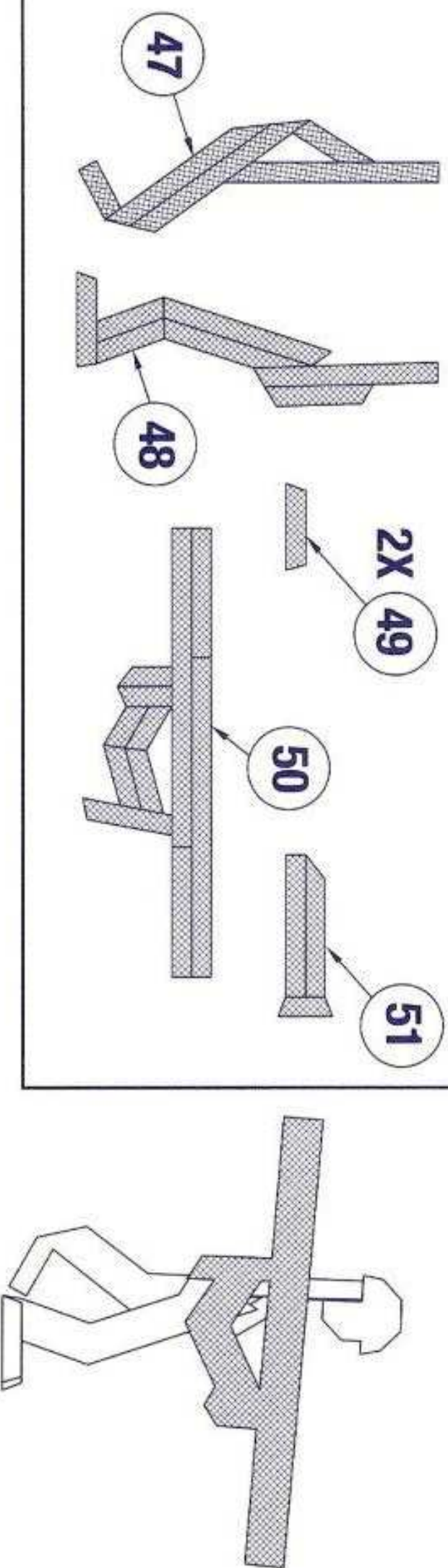

3D

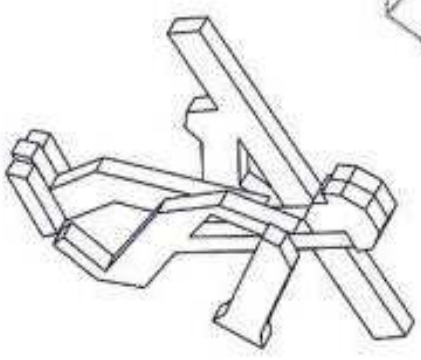

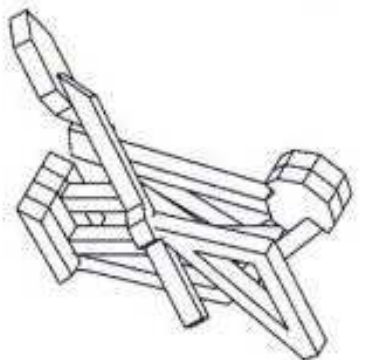
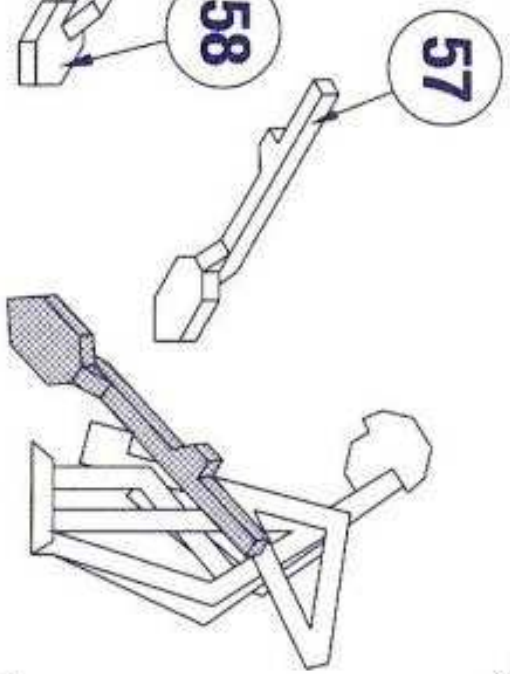
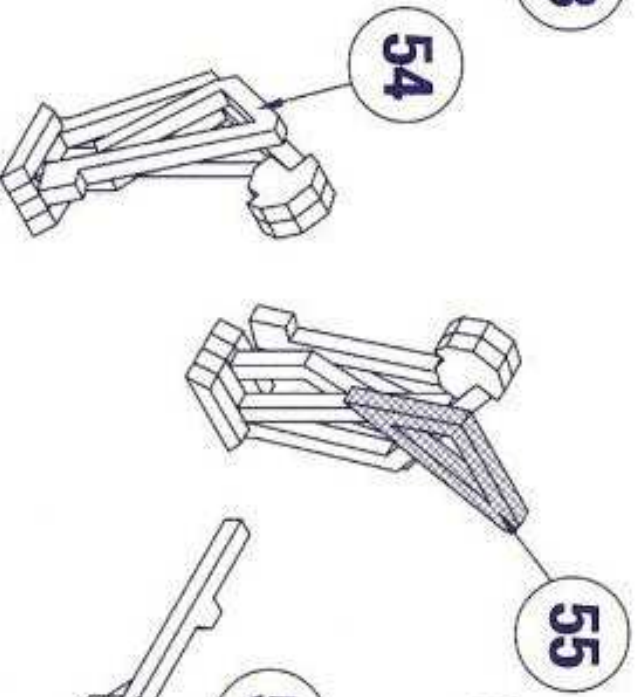
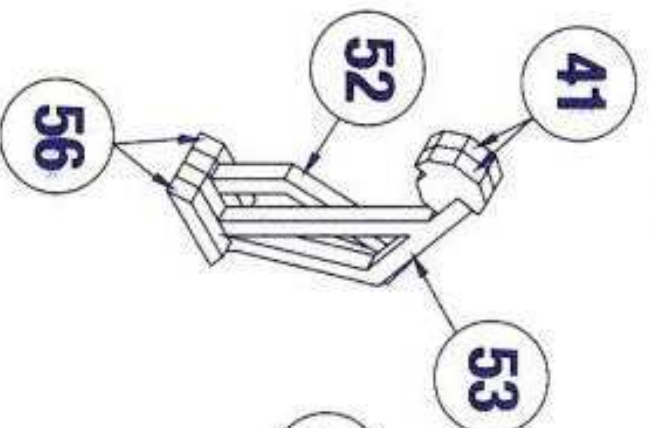
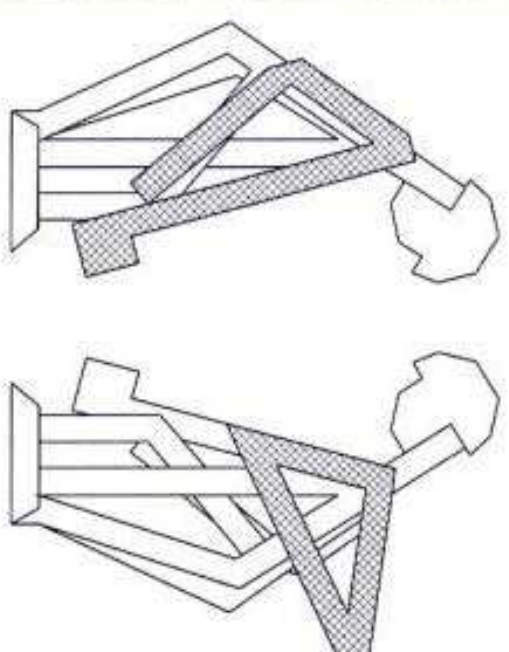
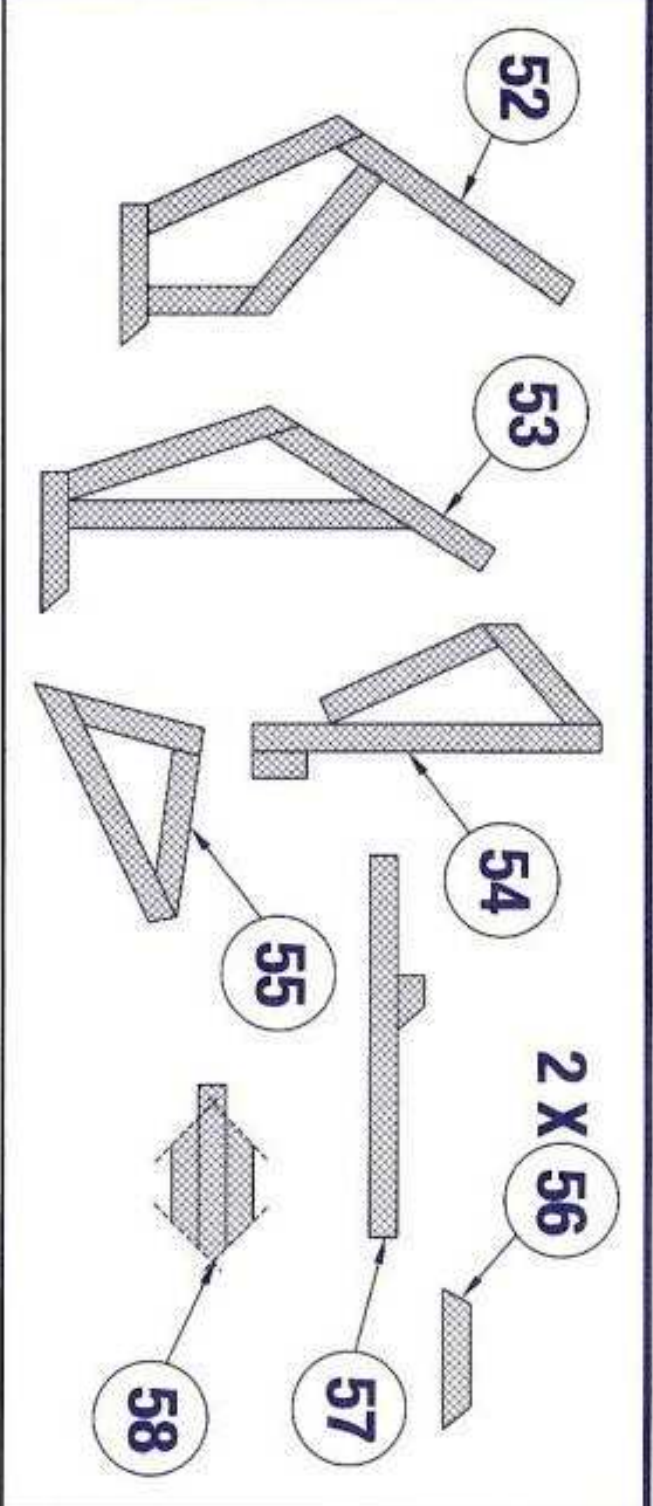

3D

3D

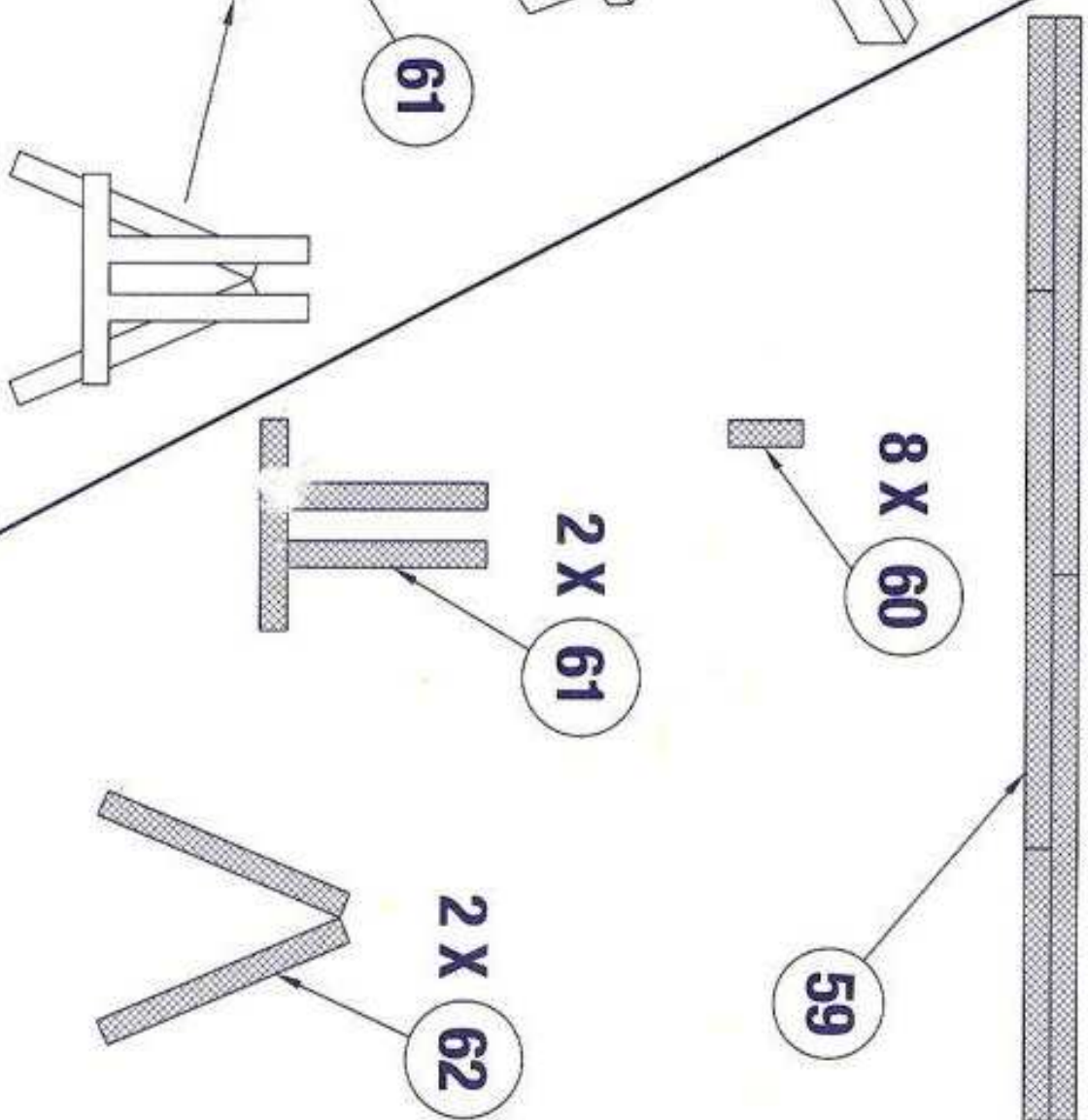
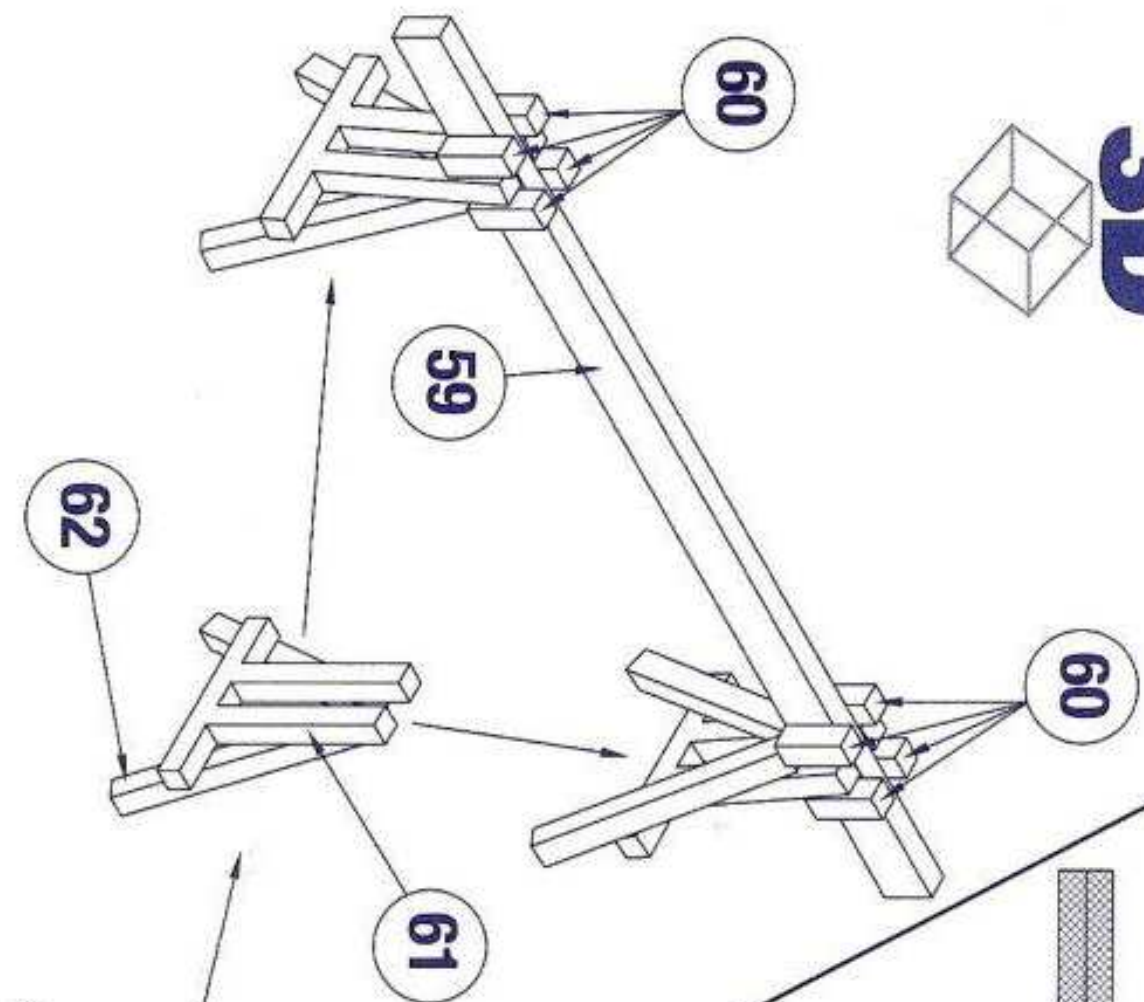

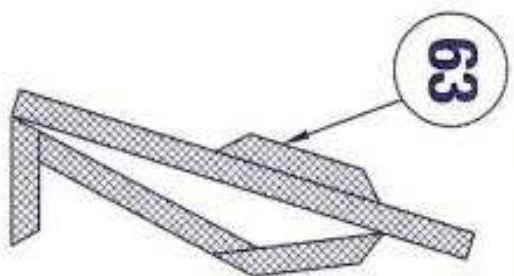

63

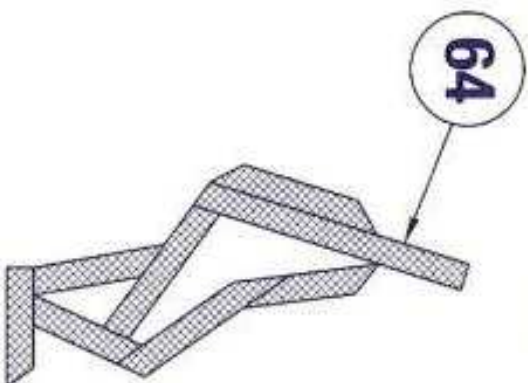

64

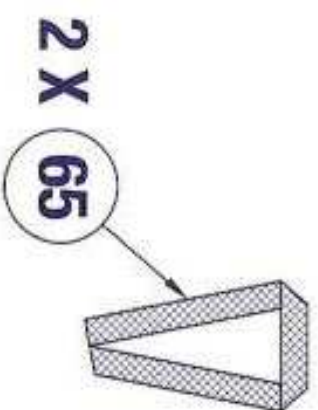

2 X 65

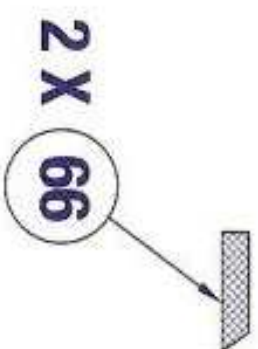

2 X 66

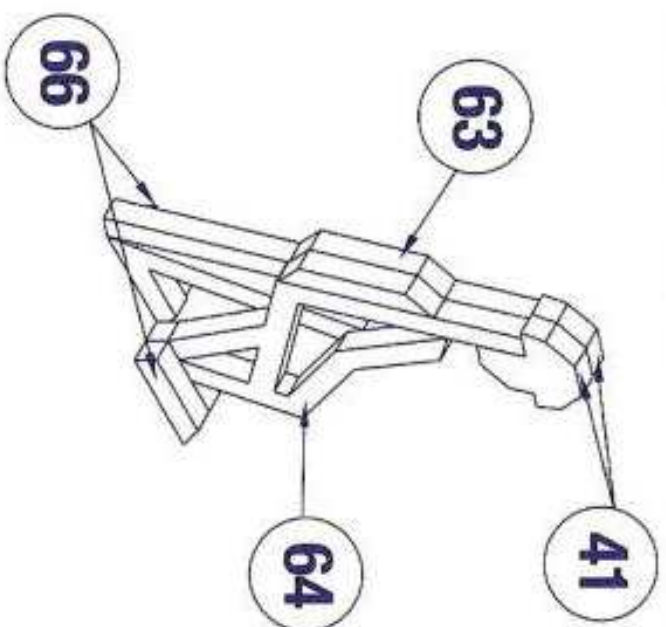

41

63

64

66

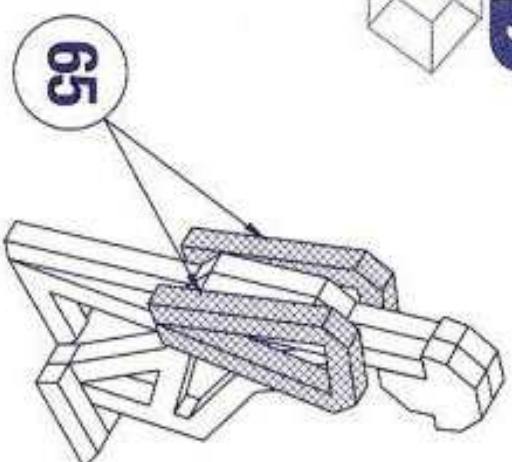
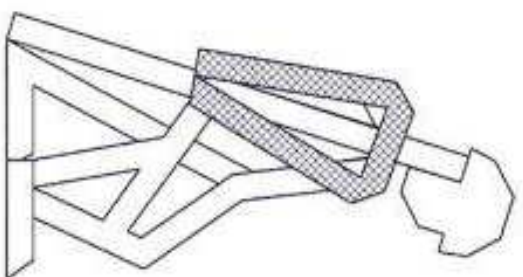

65

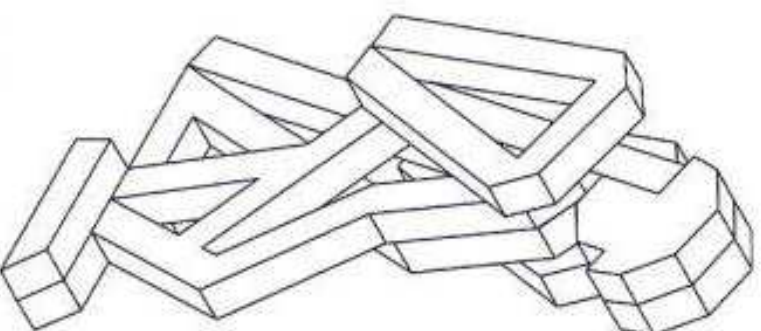

2 X 67



2 X 69

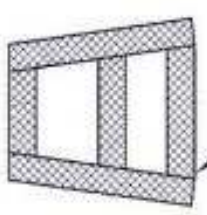

70



2 X 68

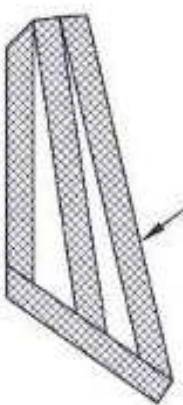

71

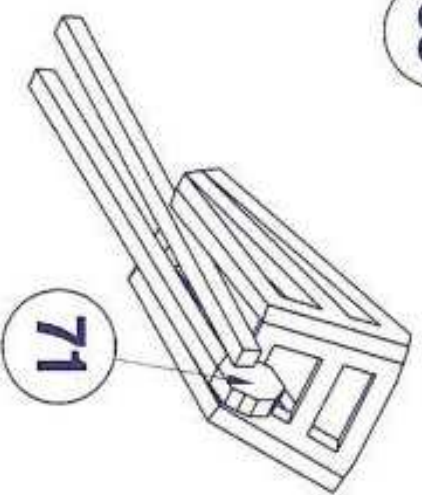
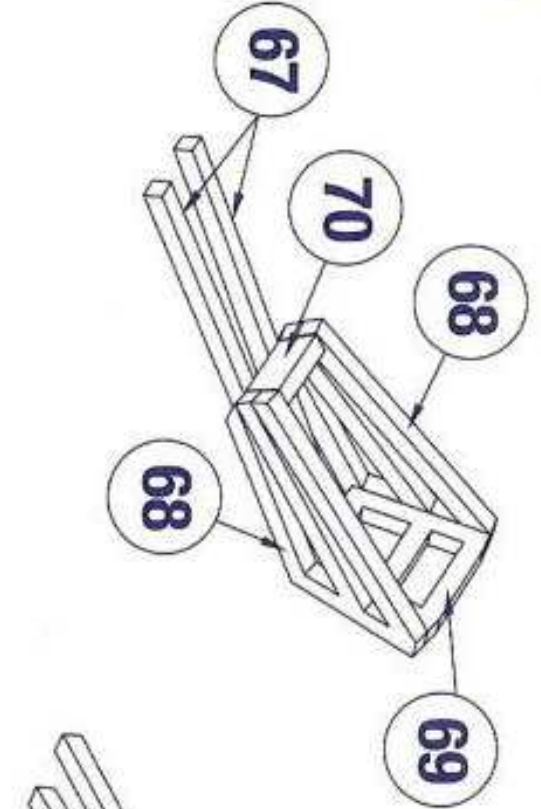

3D

