

Mississippi Boat

As the last remnant of America's rivers' glories existing during the last century, the Mississippi boat was named with public whimsy. Its hull nearly did not emerge but would show a superstructure of three to four floors. It was easily recognized with its two pairs of high chimneys. The boat was designed to give travelers the comfort of the greatest hotels.

Le bateau du Mississippi

Dernier témoin de la glorieuse traversée des fleuves américains au siècle dernier, le bateau du Mississippi était né par des ruses à modes. Sa coque émergeait à peine et laissait voir une superstructure de trois à quatre étages; on la reconnaissait facilement à sa paire de hautes cheminées. Le bateau était envisagé avec le confort des plus grands hôtels.

El barco del Mississippi

Último testigo de la gloriosa época de la navegación sobre los ríos americanos, se le dijo pateteo, el barco del Mississippi era propulsado por ruedas de paletas. Su casco surge apenas del agua y soportaba una superestructura de tres a cuatro pisos. Se reconocía fácilmente por sus dos altas chimeneas. El barco estaba concebido con todas las comodidades de los hoteles más lujosos.

La nave del Mississippi

Ultima testimonianza della gloriosa traversata dei fiumi americani nel secolo scorso, la nave del Mississippi era mossa da un sistema di propulsione con ruote a palette. La scocca emergeva appena dall'acqua, lasciando apparire una struttura di quattro piani; era inoltre facilmente riconoscibile per i suoi due grandi camini. La nave era organizzata in modo da offrire ai viaggiatori le stesse comodità dei migliori alberghi.

Mississippiampfer

Der Mississippi-Raddampfer ist der letzte Zeuge aus der Zeit der prächtigen Flußfahrten im Amerika des vergangenen Jahrhunderts. Auf drei liegenden Bohrern sind drei bis vier Decks aufgesetzt. Die beiden hohen Bohrstänne gehen zu dem markantesten Merkmalen der Schaufelradampfer, die den gleichen Komfort wie große Hotels bieten.

Mississippi-boat

De Mississippi-raddampfer, het laatste overblijfsel van de prachtige schepen die in de negentiende eeuw op de Amerikaanse rivieren voeren, werd aangedreven door schroeven. Zijn romp stak amper uit het water, maar had een bovenbouw van drie of vier verdiepingen. Hij was ook goed herkenbaar dankzij zijn twee hoge schoorstenen. Op het uiterlijk konden reizigers dezelfde luxe vinden als in de beste hotels.

ミシシッピボート

明末のアメリカの河川に活躍した豪華な船が最後の名残りの証。船のミシシッピボートは、船体は水面上にほとんど見えず、3〜4階建ての超豪華な船体で知られています。また、2本の高い煙突が特徴です。この船は、豪華なホテルと同様の快適さを提供するために設計されました。

MATCHITECTURE

PLANS • PLANOS • PIANI • ZEICHNUNGEN • PLANNEN • 設計図

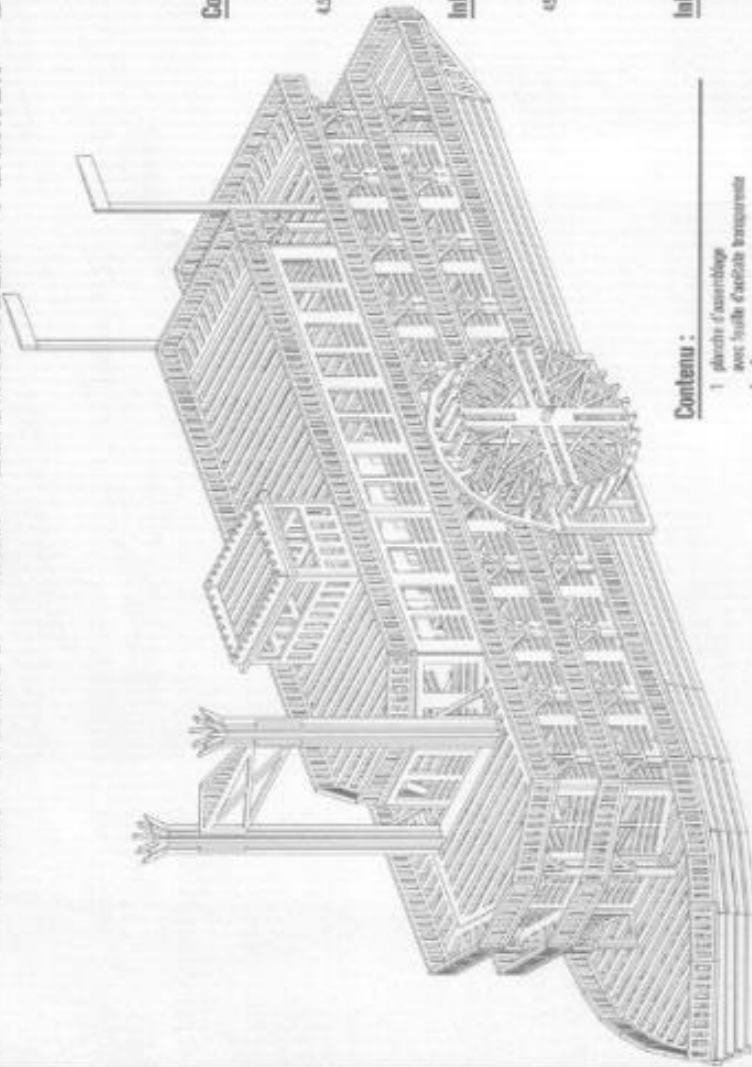

Contenido:

- 1 tabla d'ensamblaje en legño de acetato transparent
- 4 piezas
- 1 pegamento per MICROTRAM
- 4.500 MICROTRAM (57 mm/2 1/4")
- 1 celo a base (120 ml/4 oz)
- 1 pegante per MICROTRAM
- 2 piezas
- 2 biseladora
- 2 tornillos

Inhalt:

- 1 versamplingsplaat met doorzichtig Acetato
- 4 delen
- 1 MICROTRAM-bevorder
- 4.500 MICROTRAM (57 mm/2 1/4")
- 1 basisfilm (120 ml/4 oz)
- 1 plakmiddel voor de MICROTRAM
- 2 schroeven
- 2 bijzetsel
- 2 schroeven

Inhoud:

- 1 versamplingsplaat met transparant lijd van acetate
- 4 delen
- 1 lijm voor MICROTRAM
- 4.500 MICROTRAM (57 mm/2 1/4")
- 1 basisfilm (120 ml/4 oz)
- 1 plak voor MICROTRAM
- 2 plak
- 2 schroeven
- 2 schroeven

内容:

- 1 透明シートと組み立てボート
- 4 クラップ
- 1 マイクロビームコーター
- 4500 マイクロビーム (57mm/2 1/4")
- 1 木工用接着剤 (120ml/4oz)
- 1 マイクロビームコーティング
- 2 ビス
- 2 ビス

Contenu:

- 1 planche d'assemblage avec feuille d'acétate transparente
- 4 pièces
- 1 colle-MICROTRAM
- 4.500 MICROTRAM (57 mm/2 1/4")
- 1 celo à base (120 ml/4 oz)
- 1 colle pour MICROTRAM
- 2 pièces
- 2 biseauteuse
- 2 vis

Contenido:

- 1 tabla de ensamble con hoja de acetato transparente
- 4 piezas
- 1 cola-MICROTRAM
- 4.500 MICROTRAM (57 mm/2 1/4")
- 1 pegamento de madera (120 ml/4 oz)
- 1 pega para MICROTRAM
- 2 piezas
- 2 biseladoras

Contents:

- 1 assembly board with clear acetate sheet
- 4 clips
- 1 MICROBEAM cutter
- 4,500 MICROBEAMS (2 1/4 in. x 57 mm)
- 1 wood glue (4 oz/120 ml)
- 1 MICROBEAM beams
- 2 glue
- 2 glue
- 2 glue

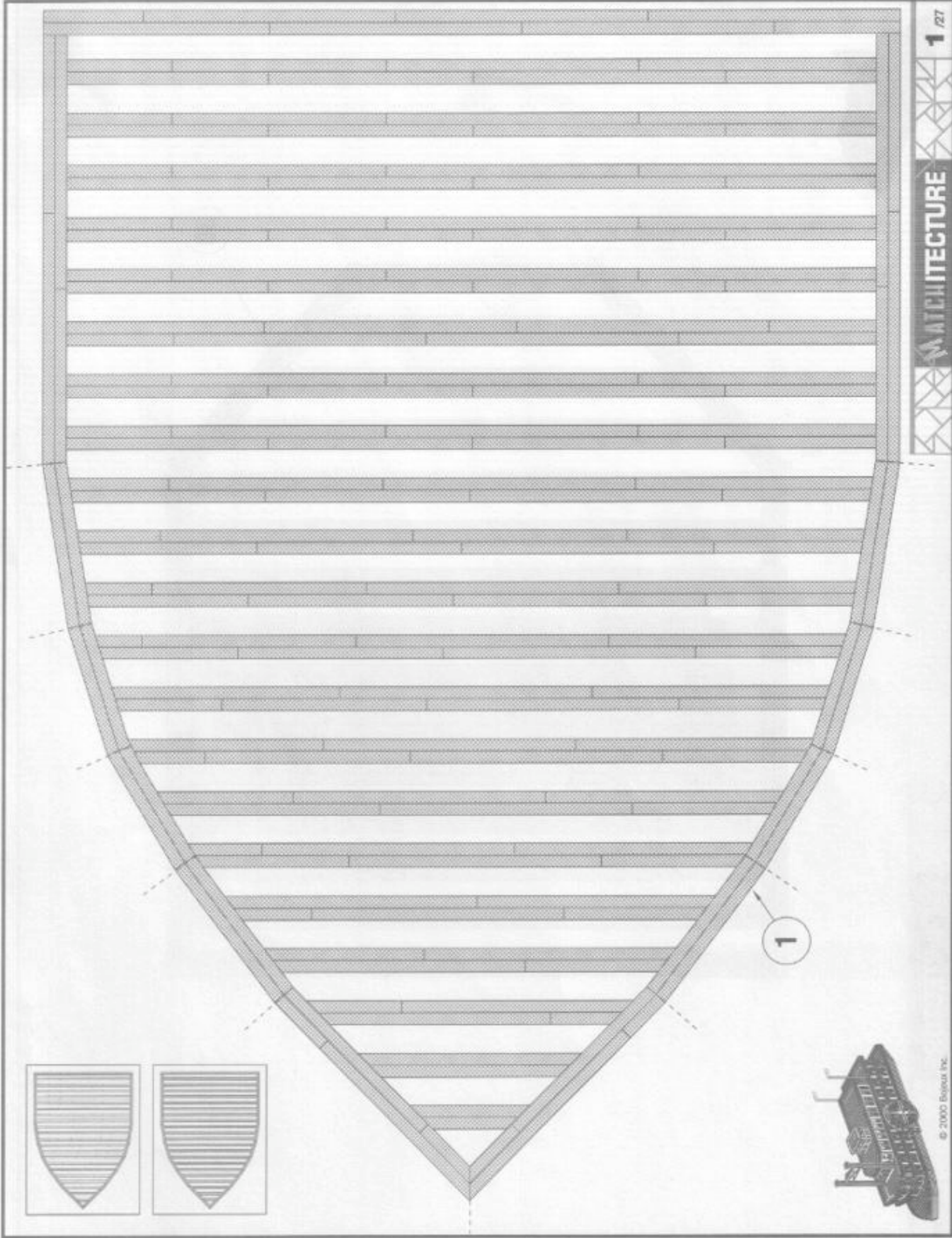

1

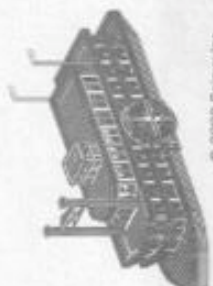

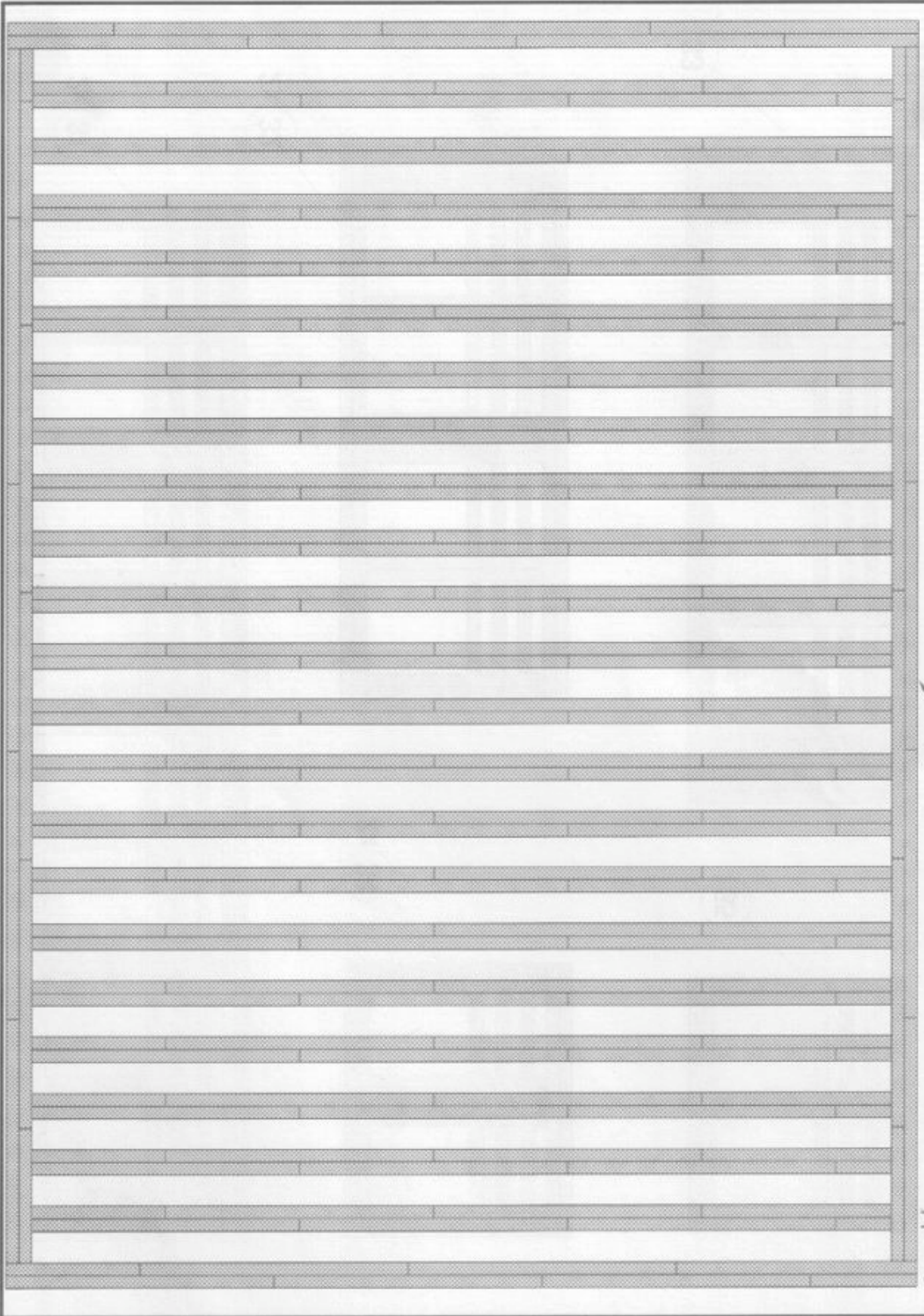

2





3



3D

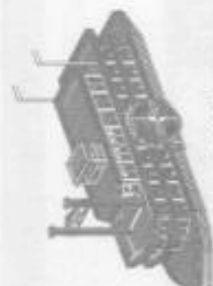
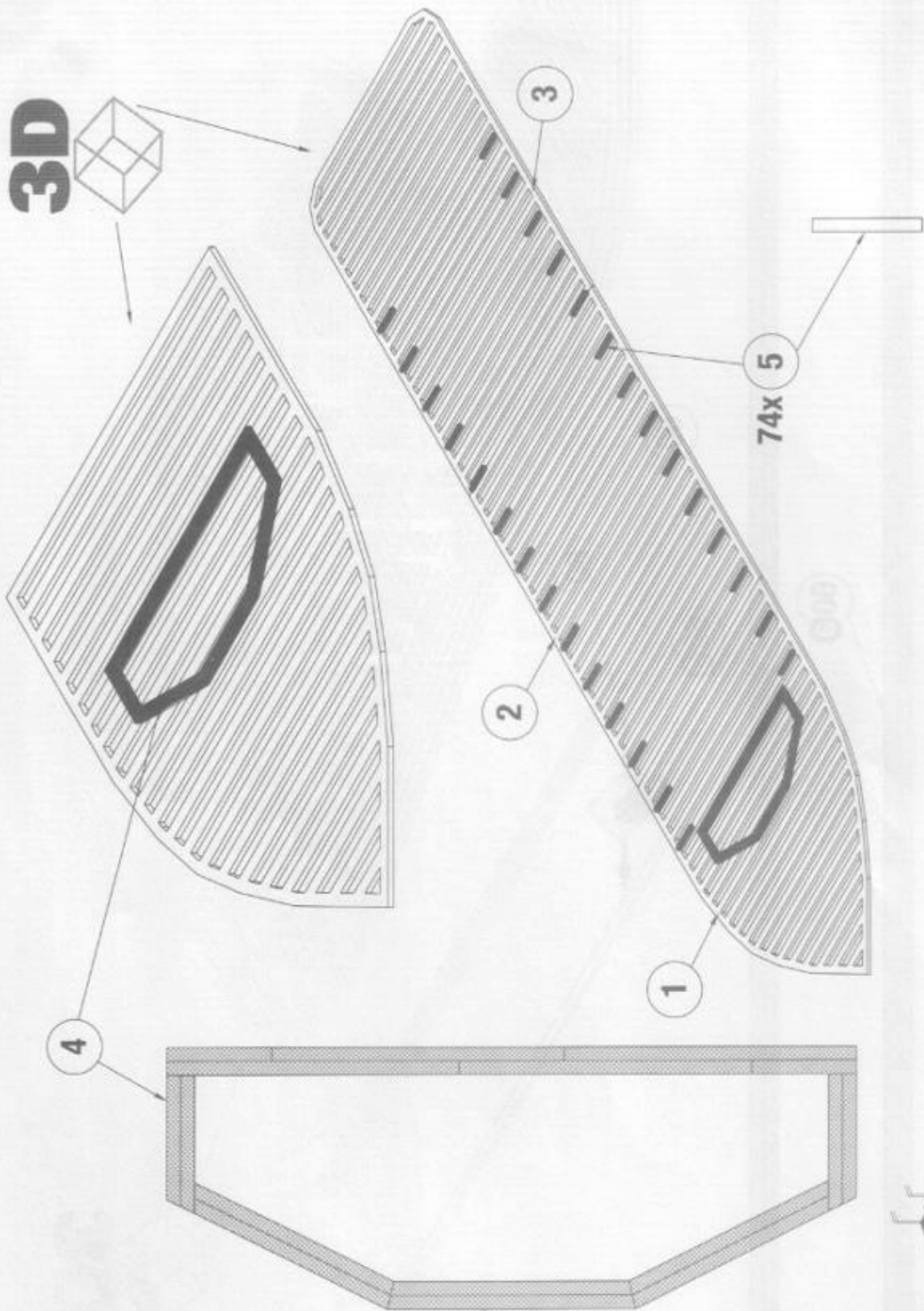

© 2000 Microsoft Inc.

4x6

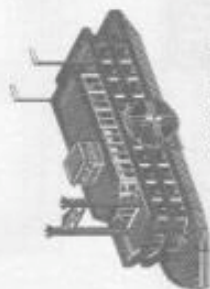
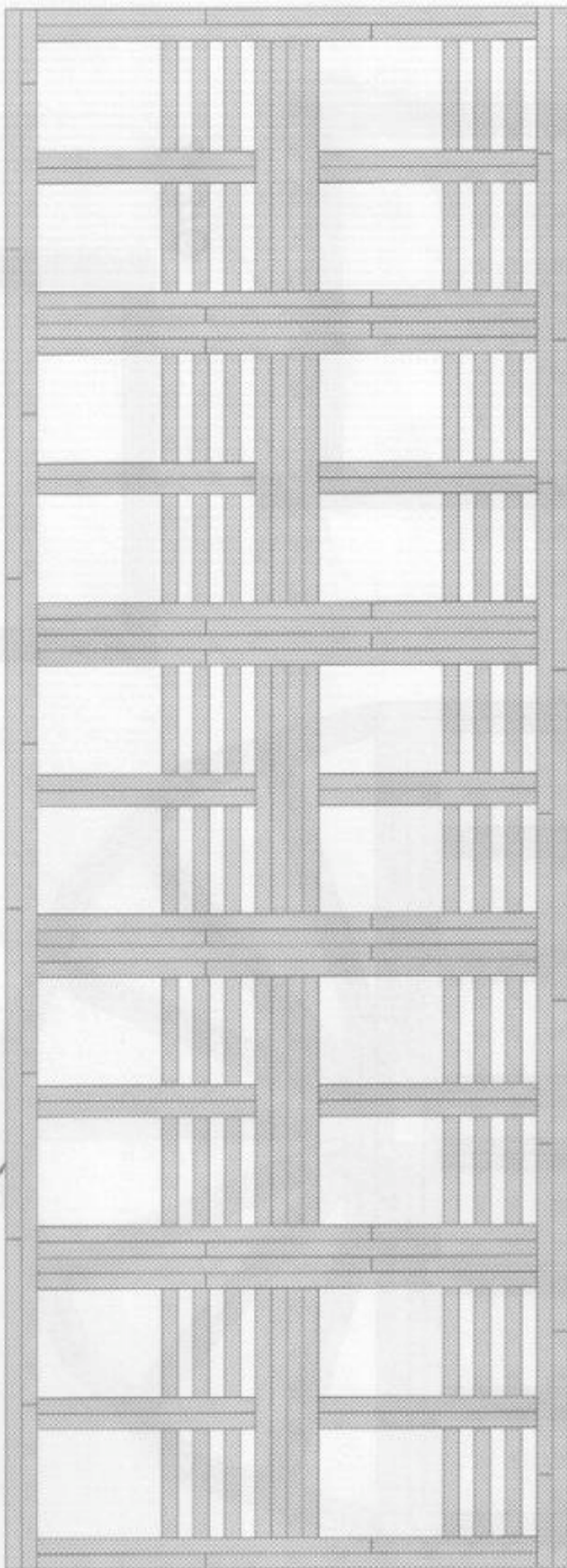

© 2000 Belpex Inc.

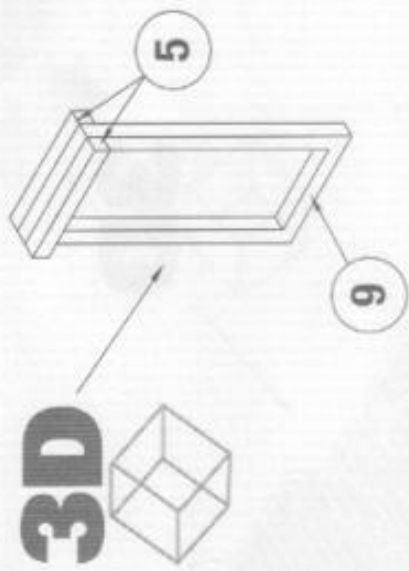

3x 8

7

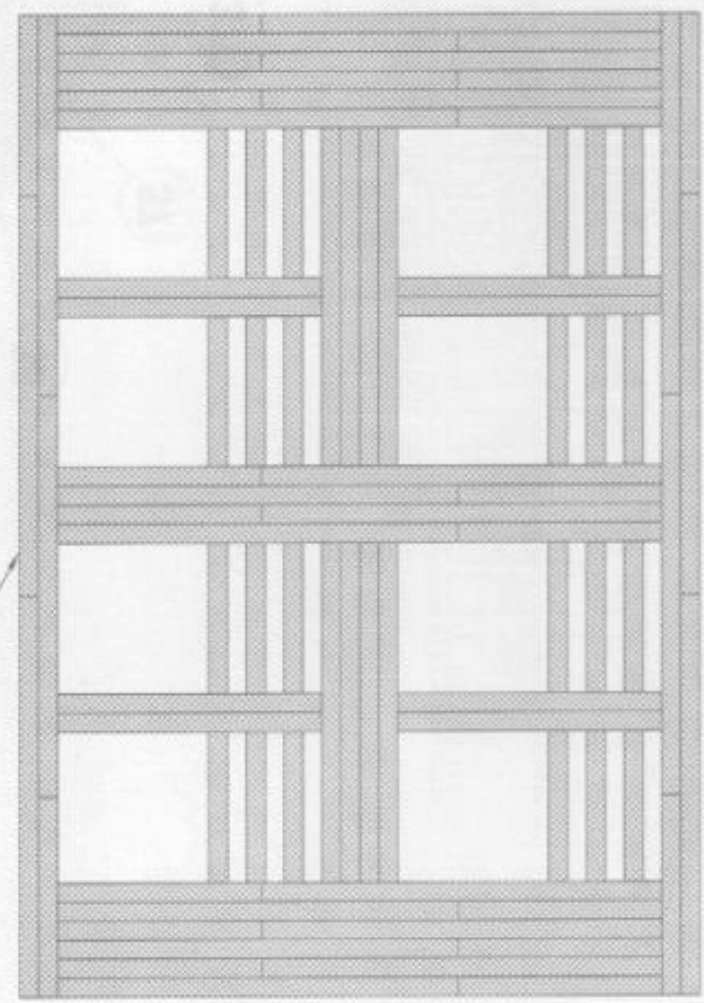
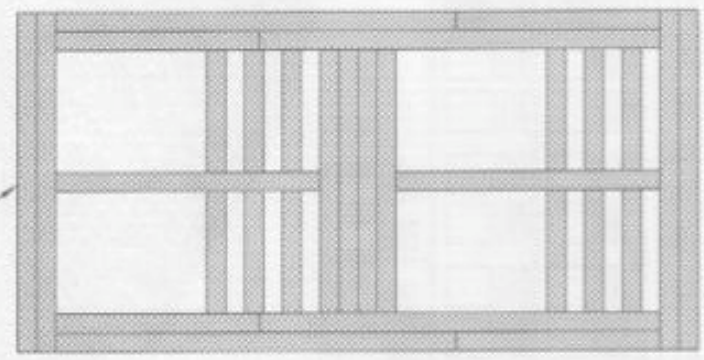

11x 9

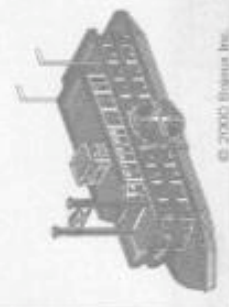
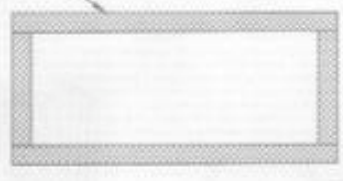

10

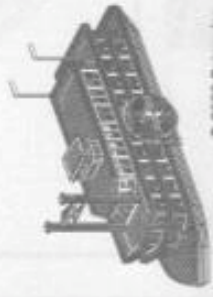
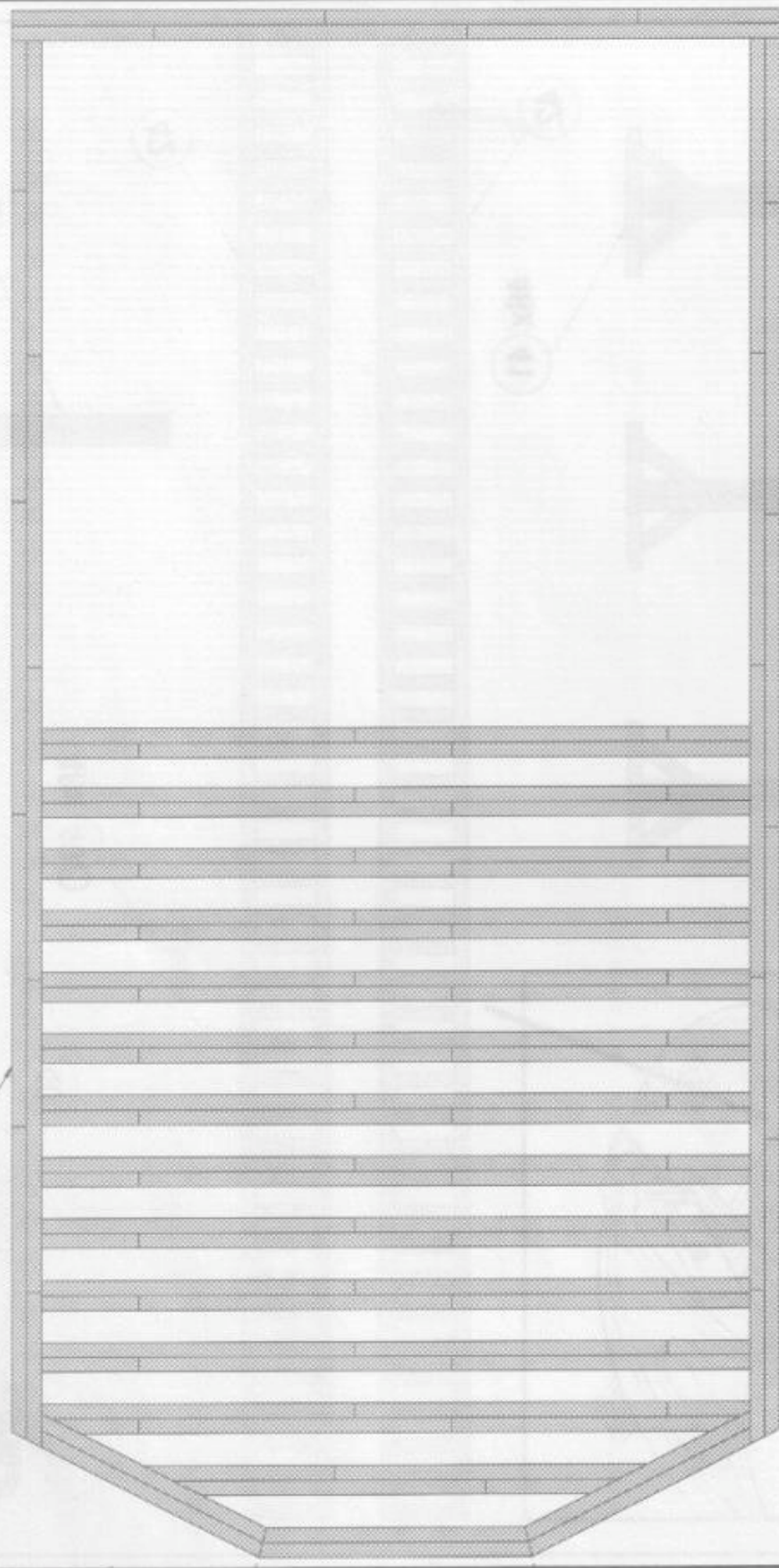

11

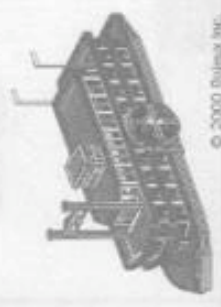
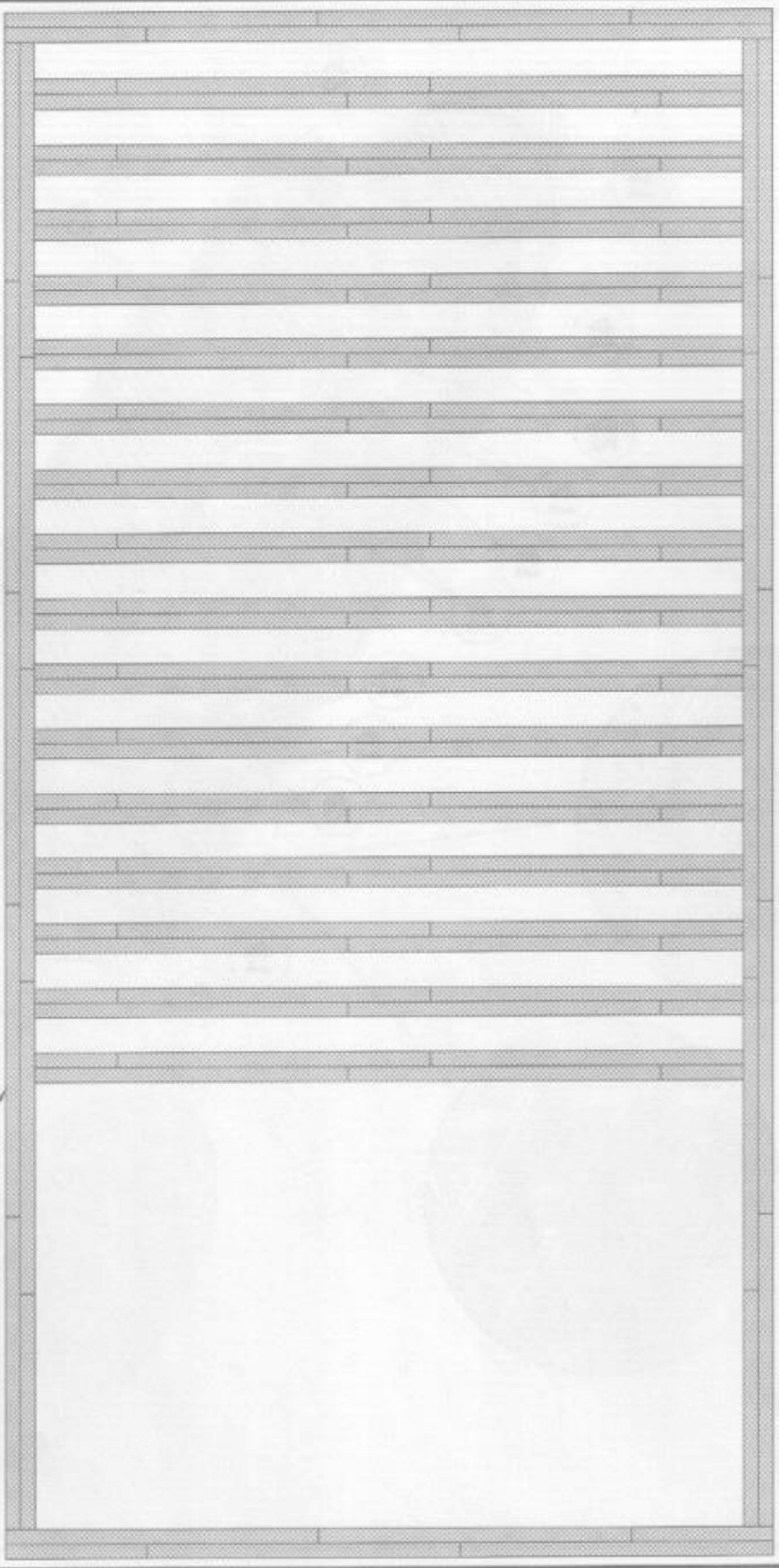

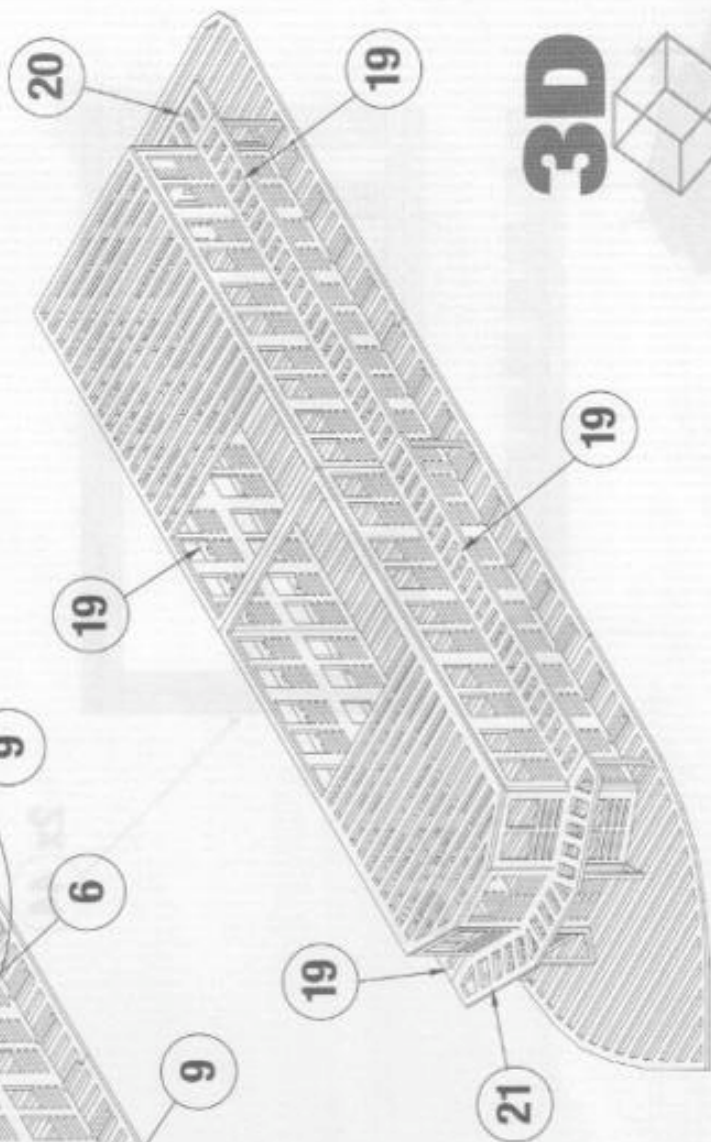
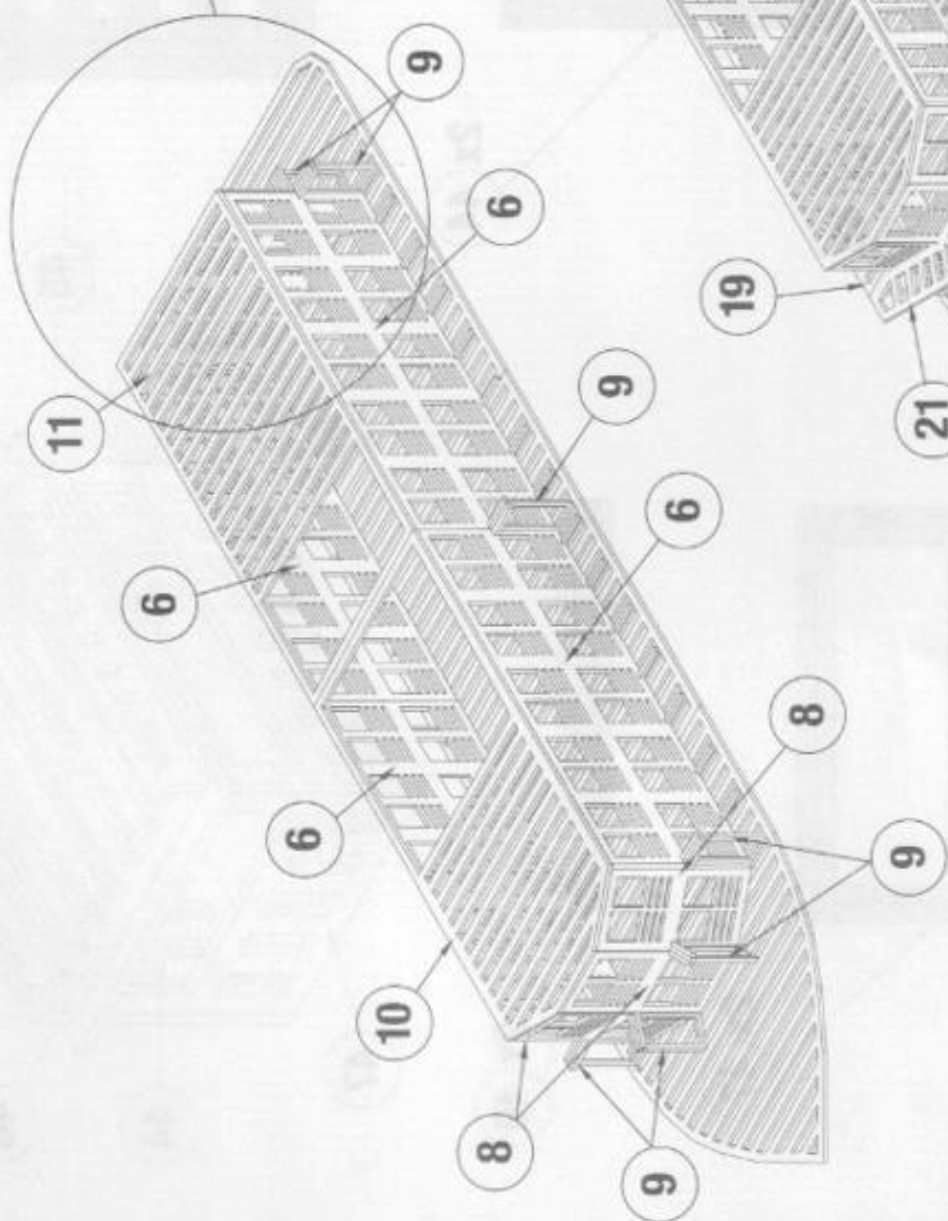
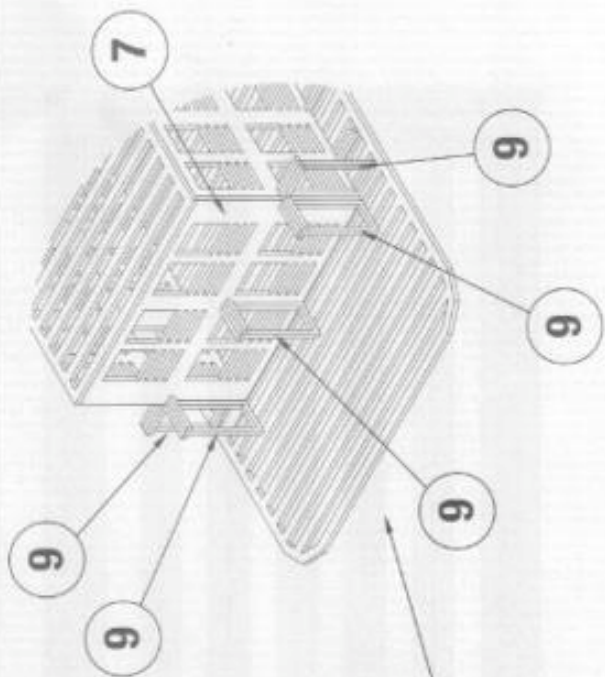

3D

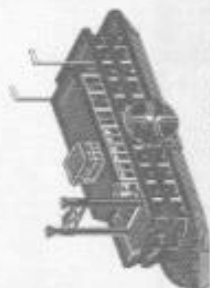

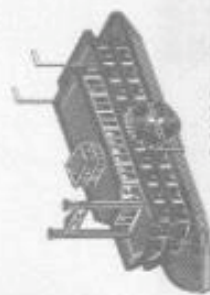
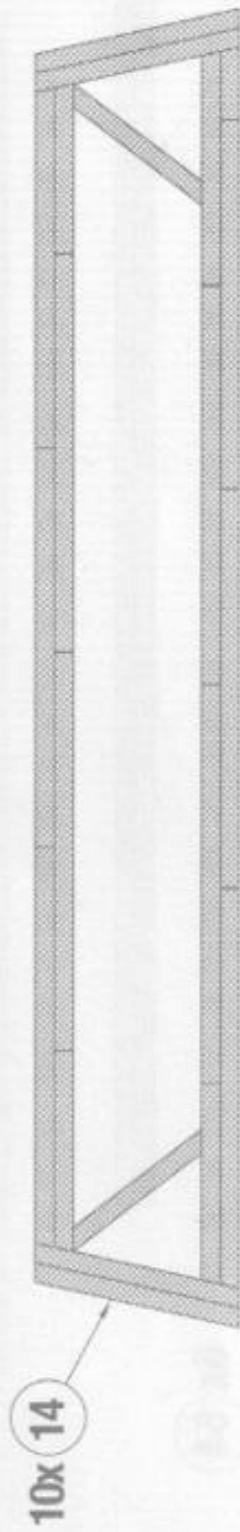
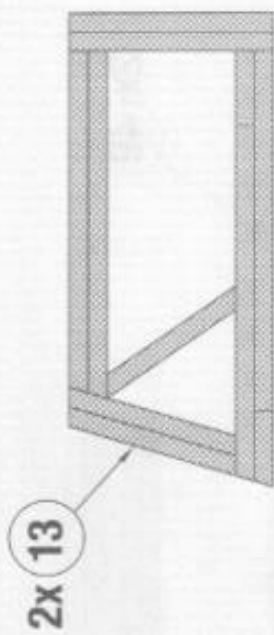

8x 19



2x 20

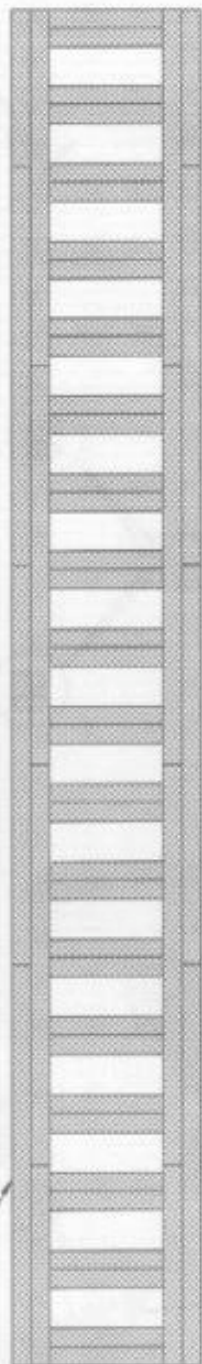

2x 21

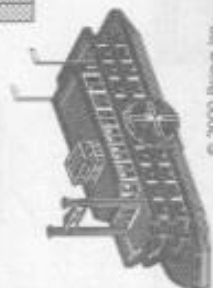
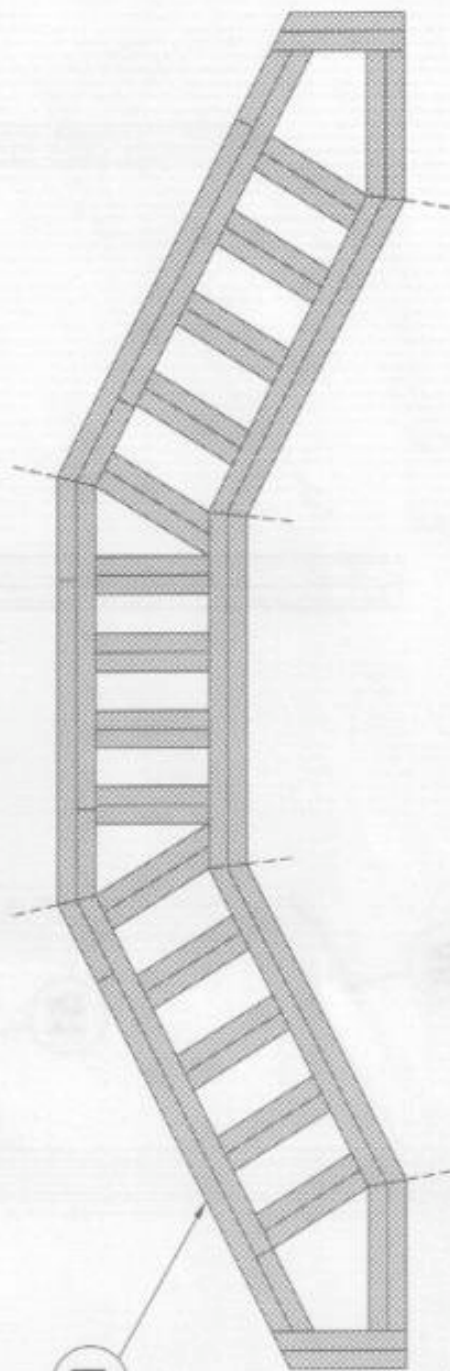

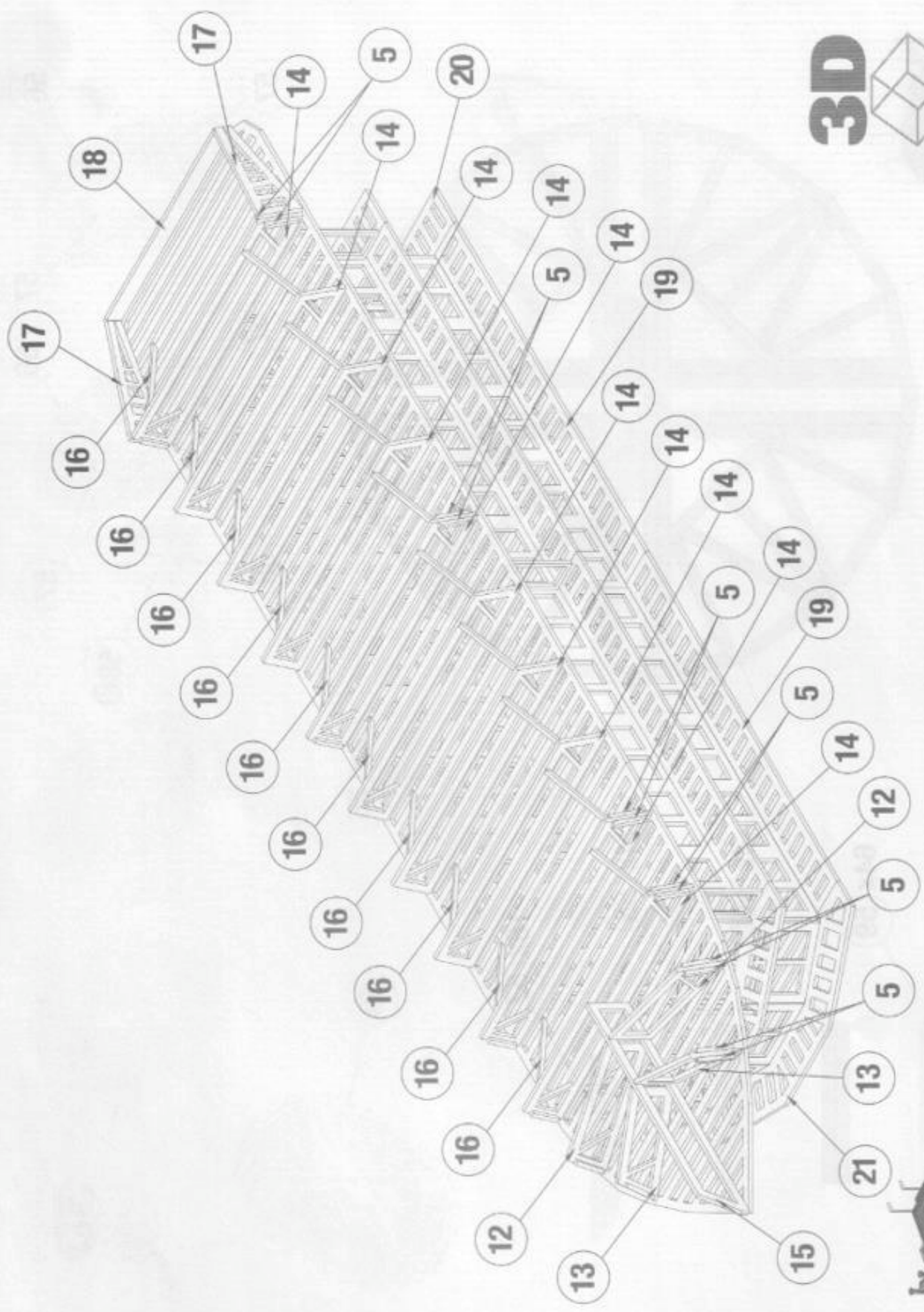

3D

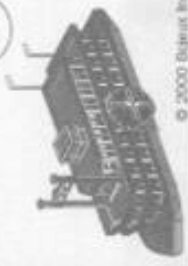

3D

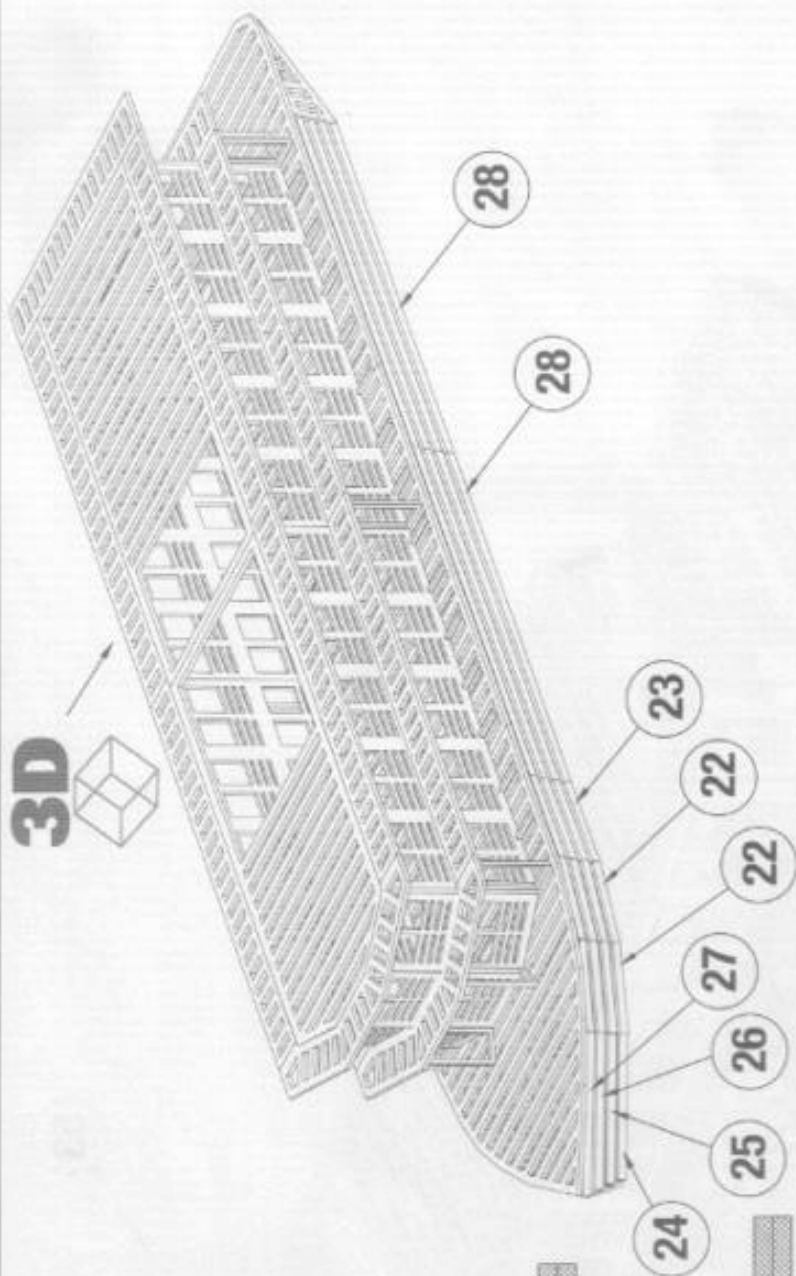

16x 22



8x 23



2x 24



2x 25



2x 26



2x 27

16x 28



© 2003 BigBox Inc.

29

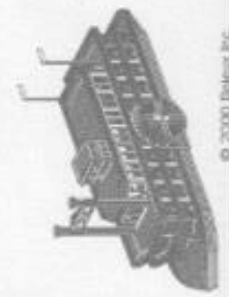
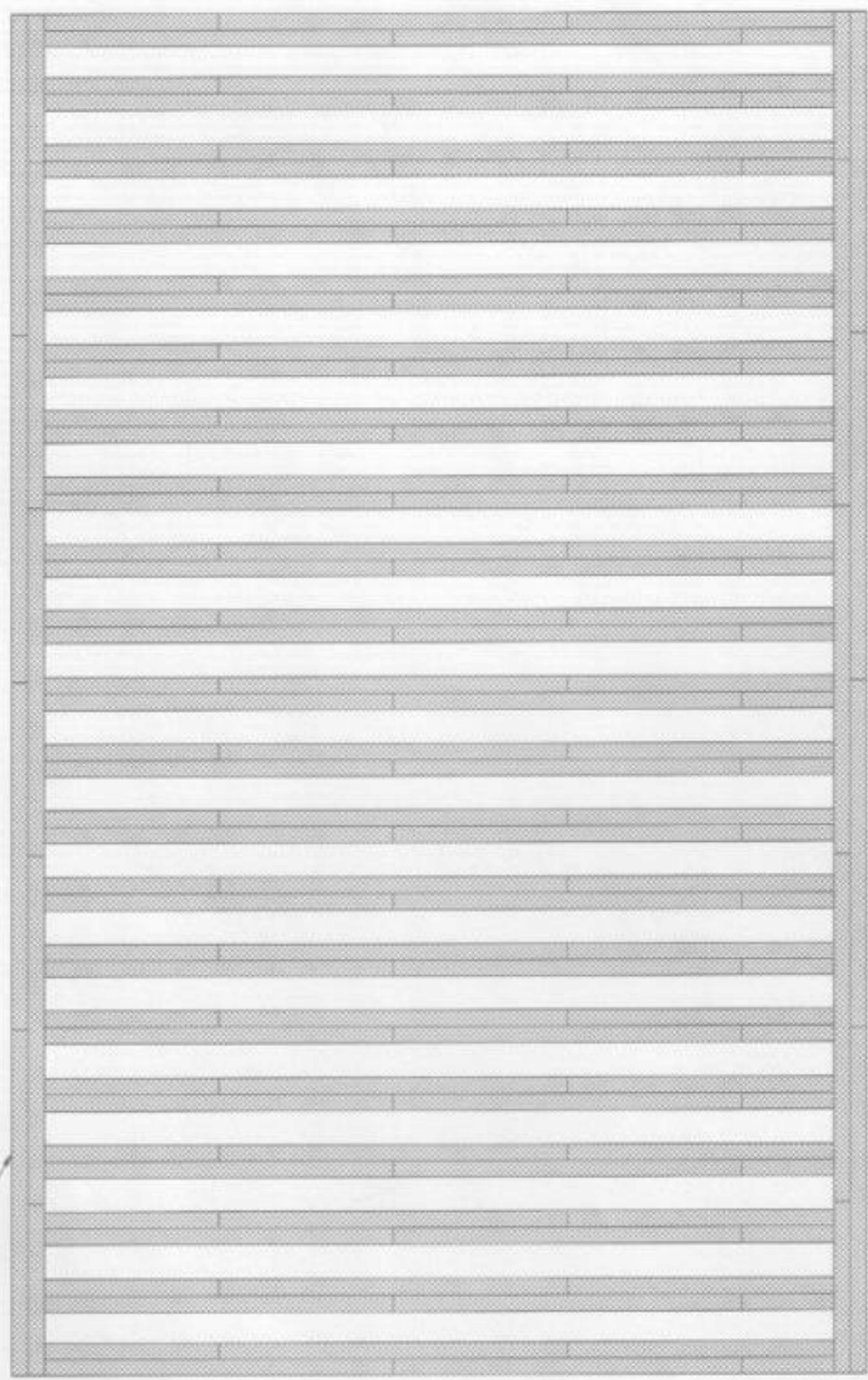

© 2000 Deltek Inc.

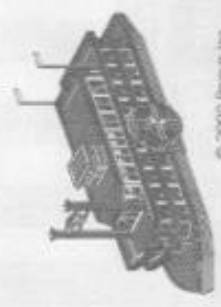
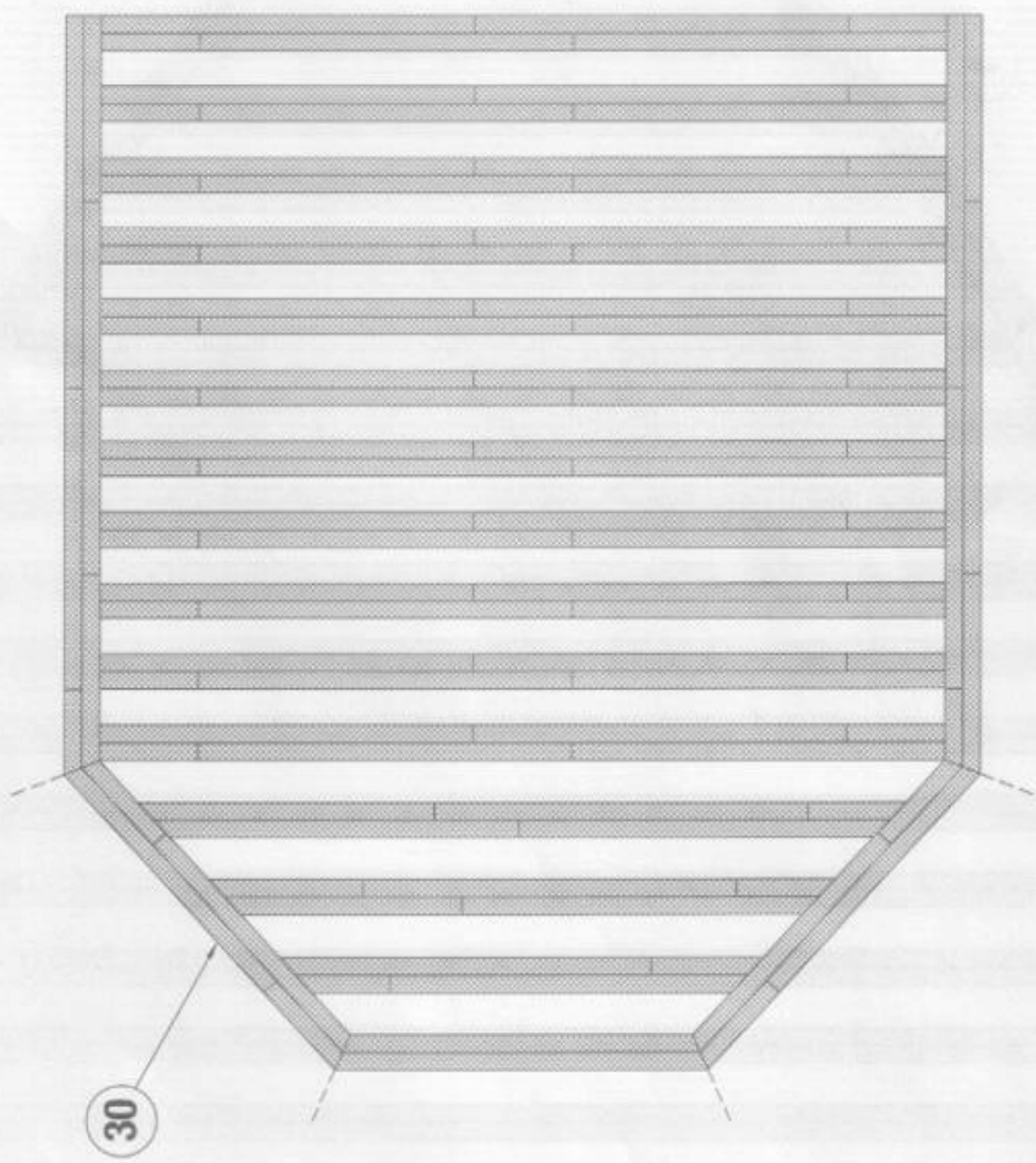

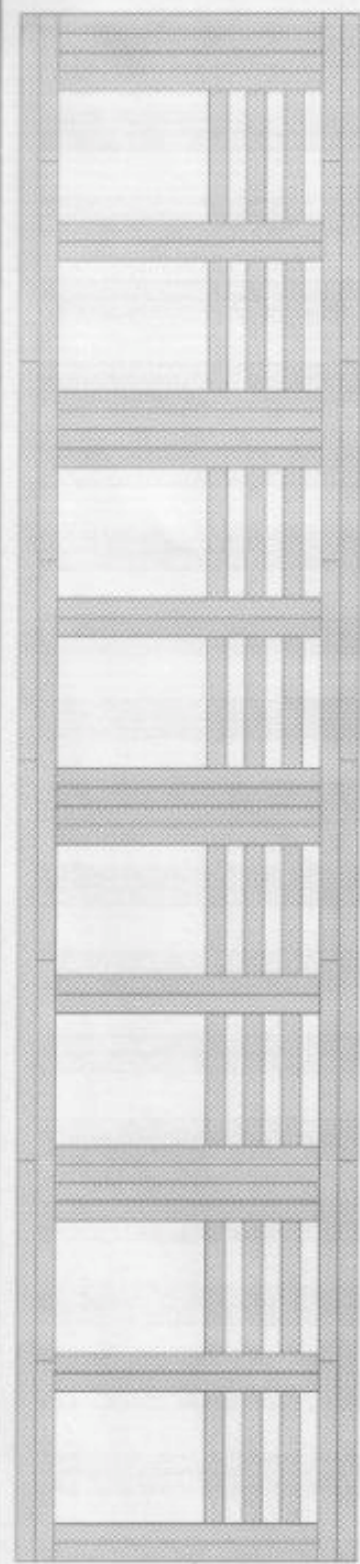

2x 31

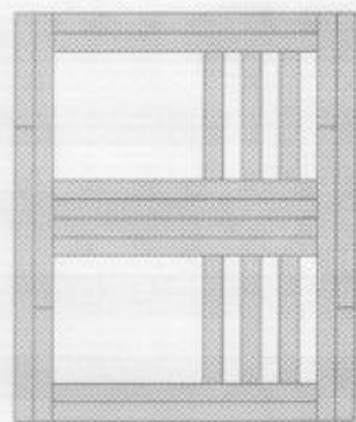

2x 34

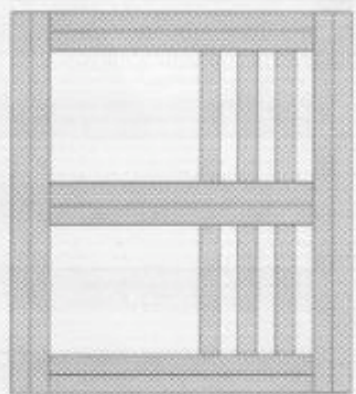

35

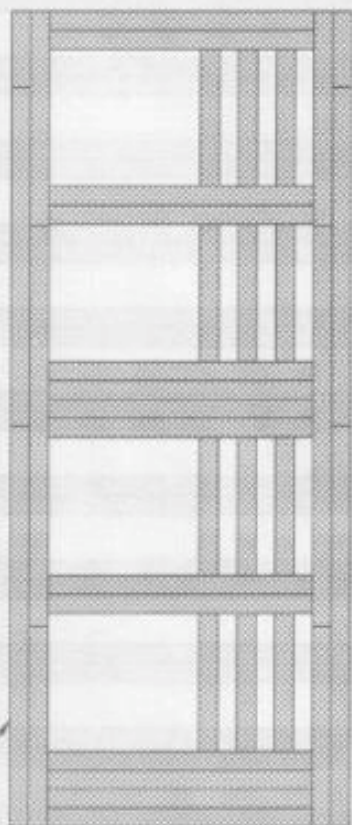

2x 32

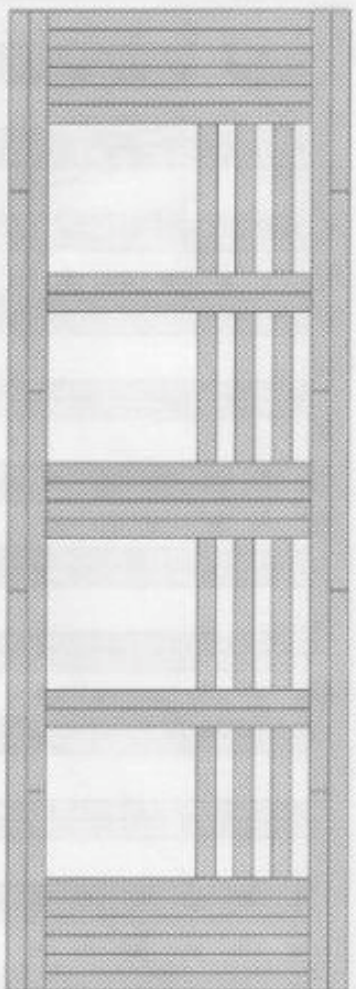

33



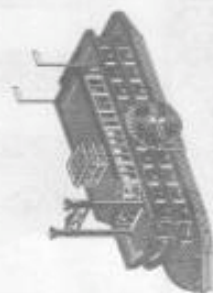
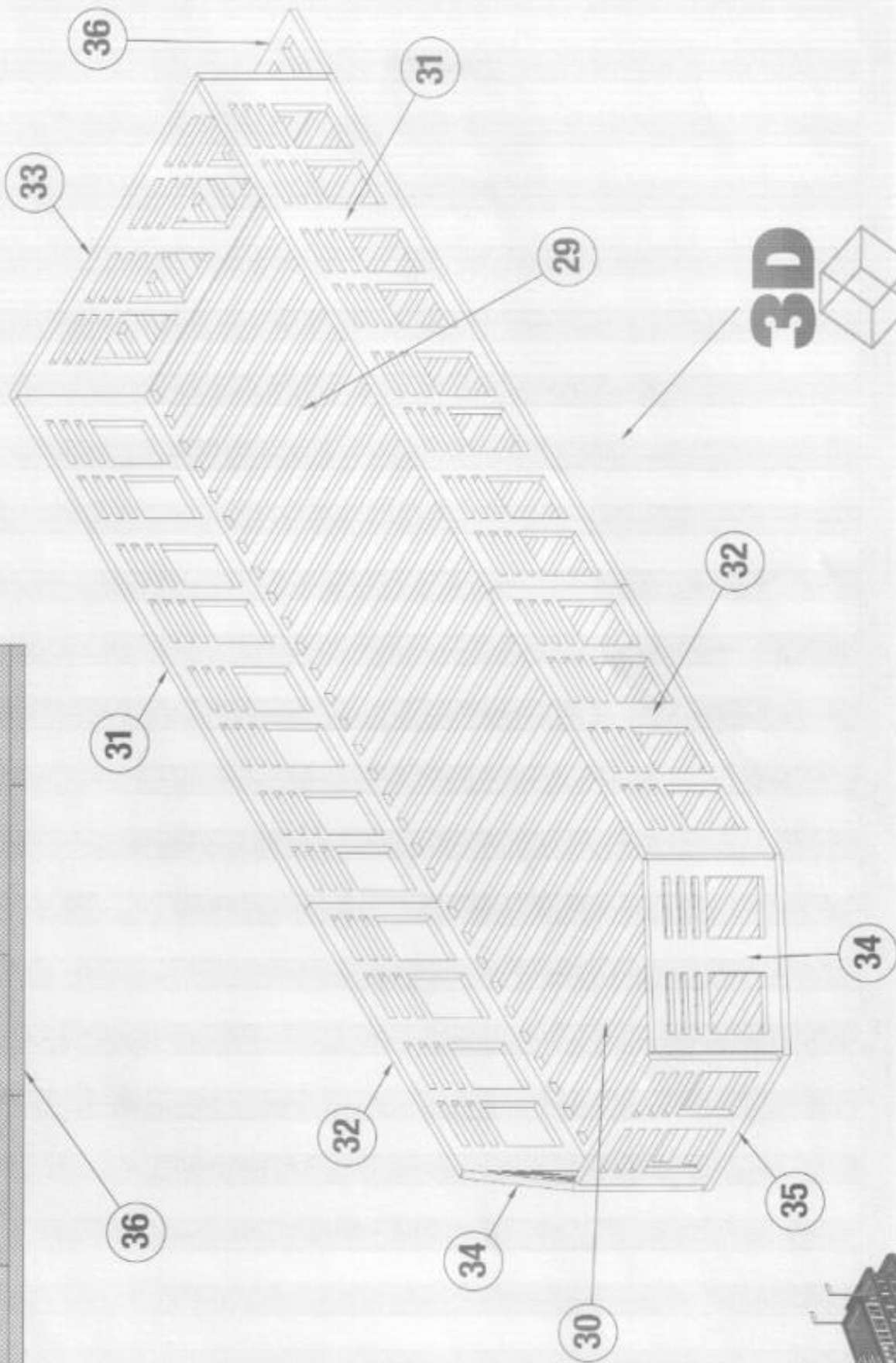
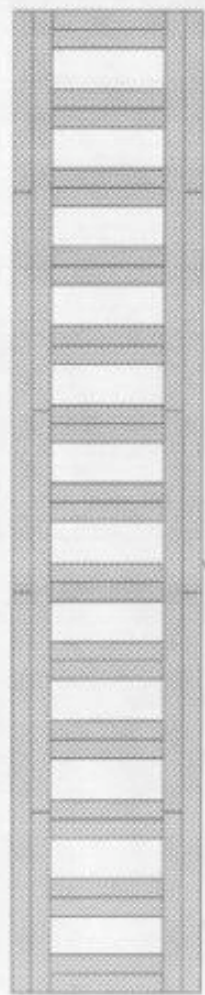

3D

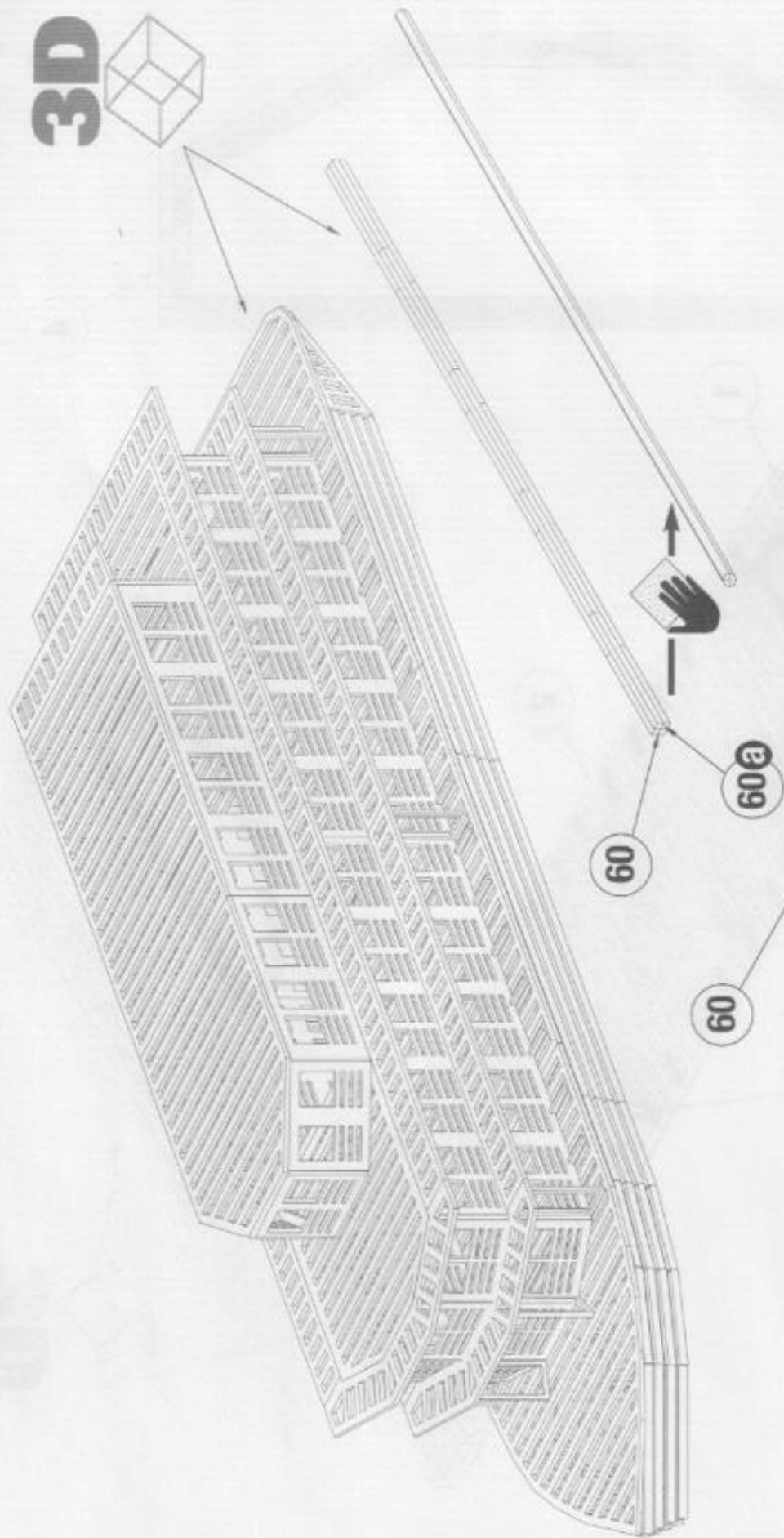

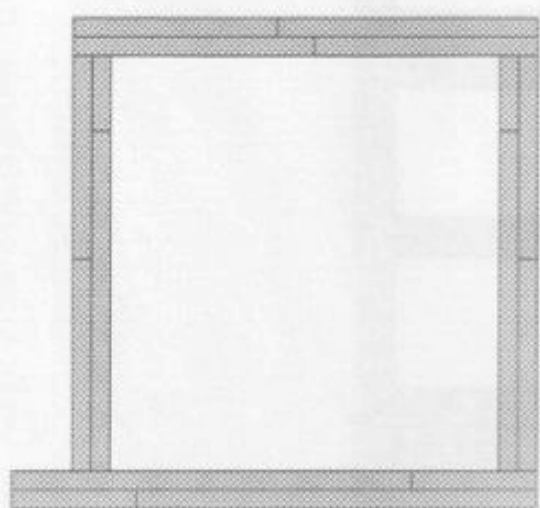

2x 37

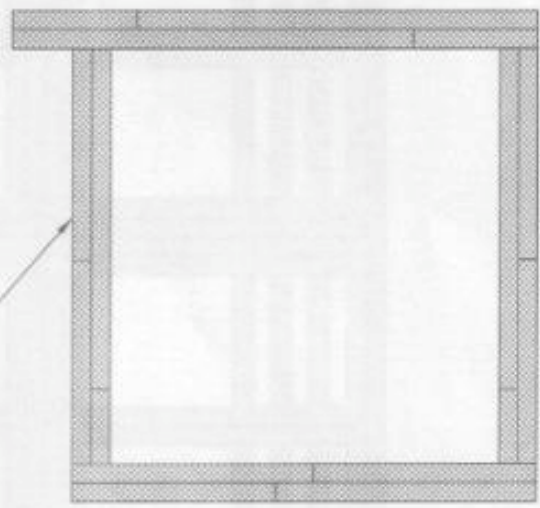

2x 37a

2x 38

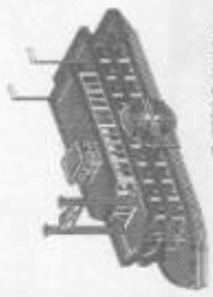
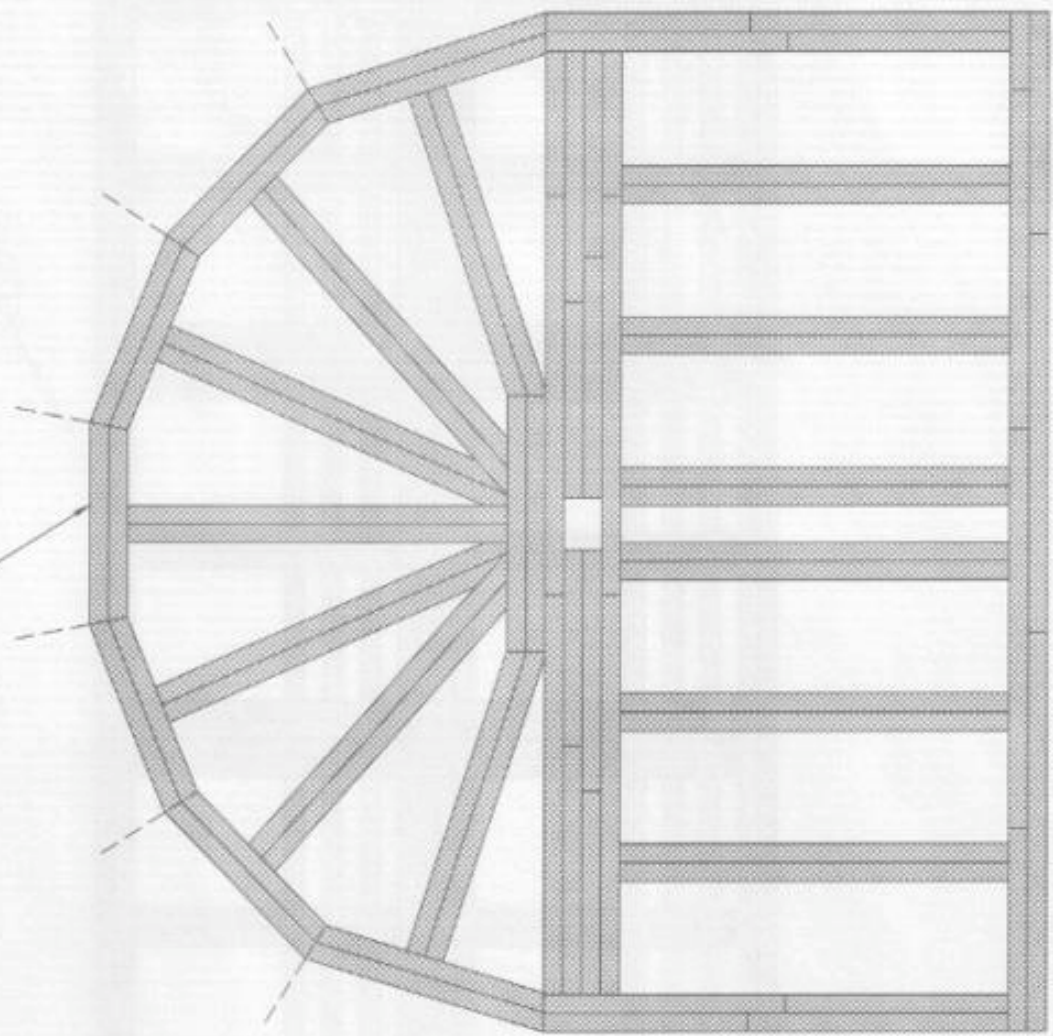

3D

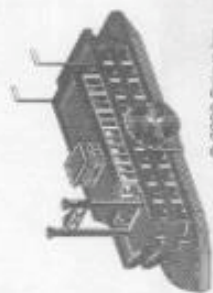
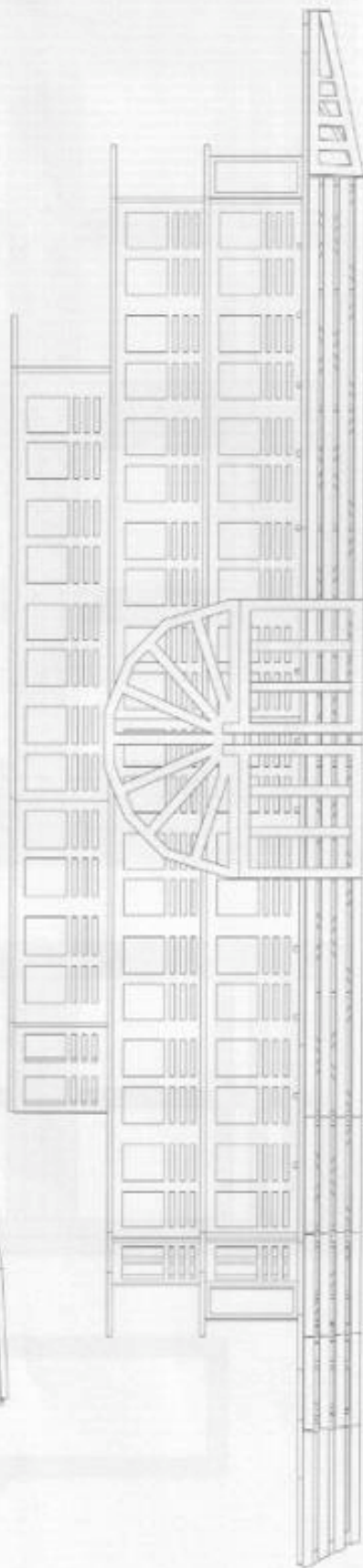
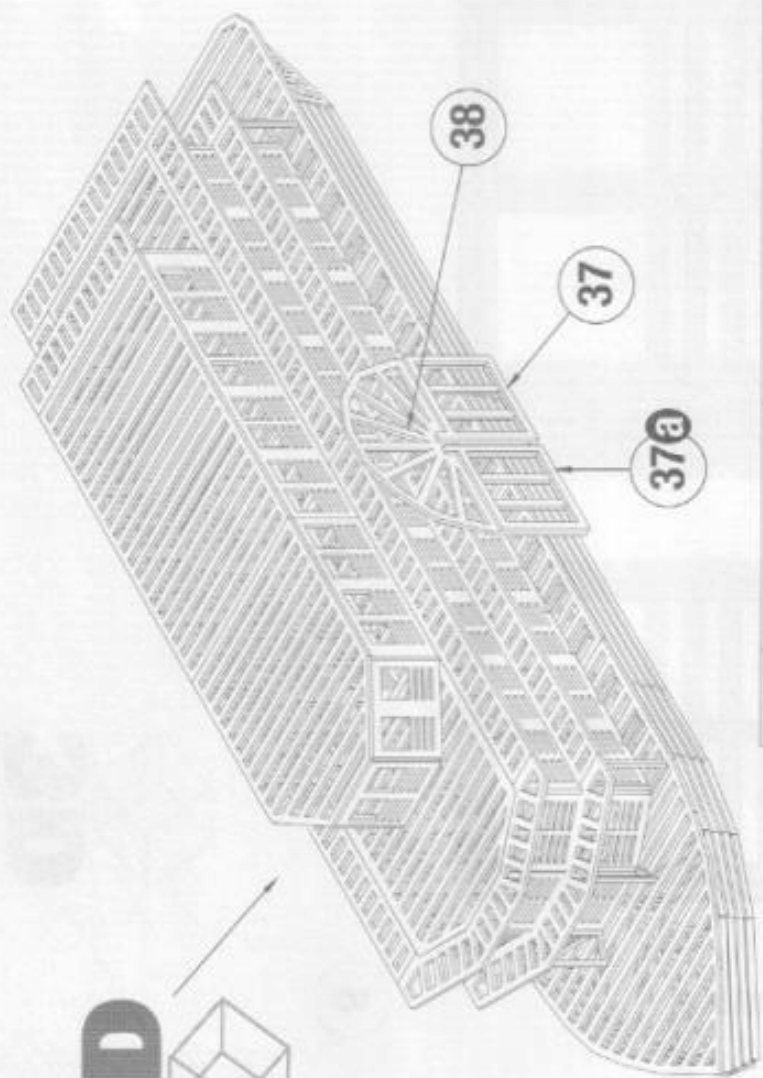

© 2000 Sybus Inc.

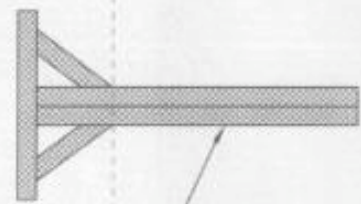

2x 39

48x 40



48x 40

42



40a

40

3D

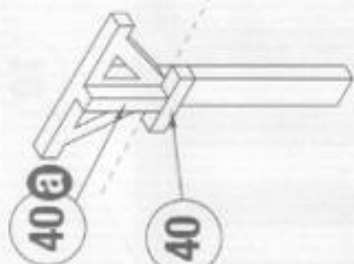

46x 41

42

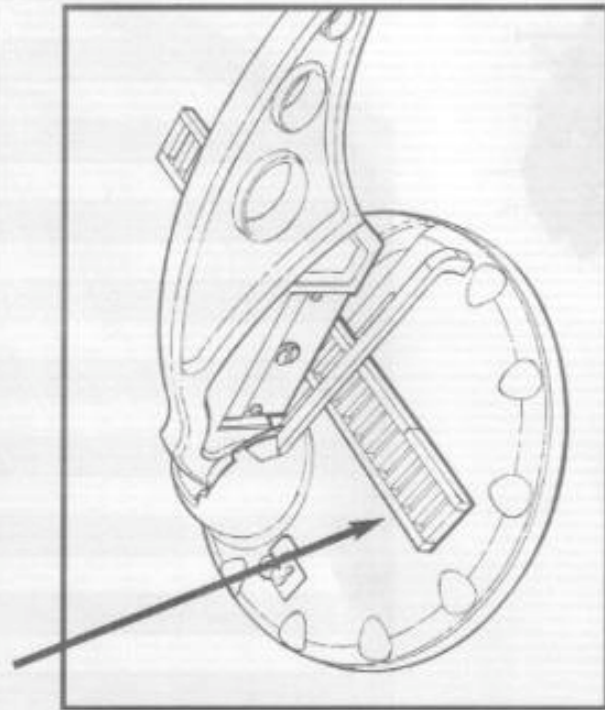
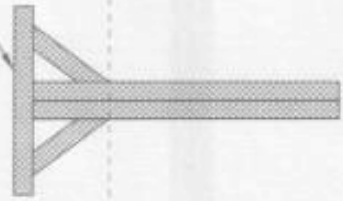
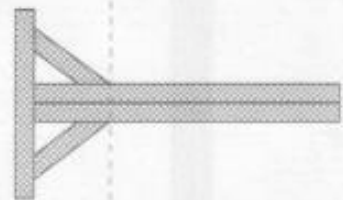
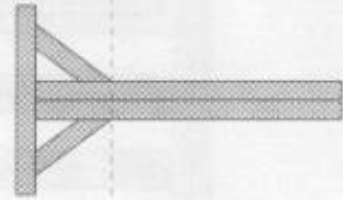

3D

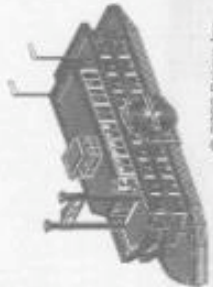
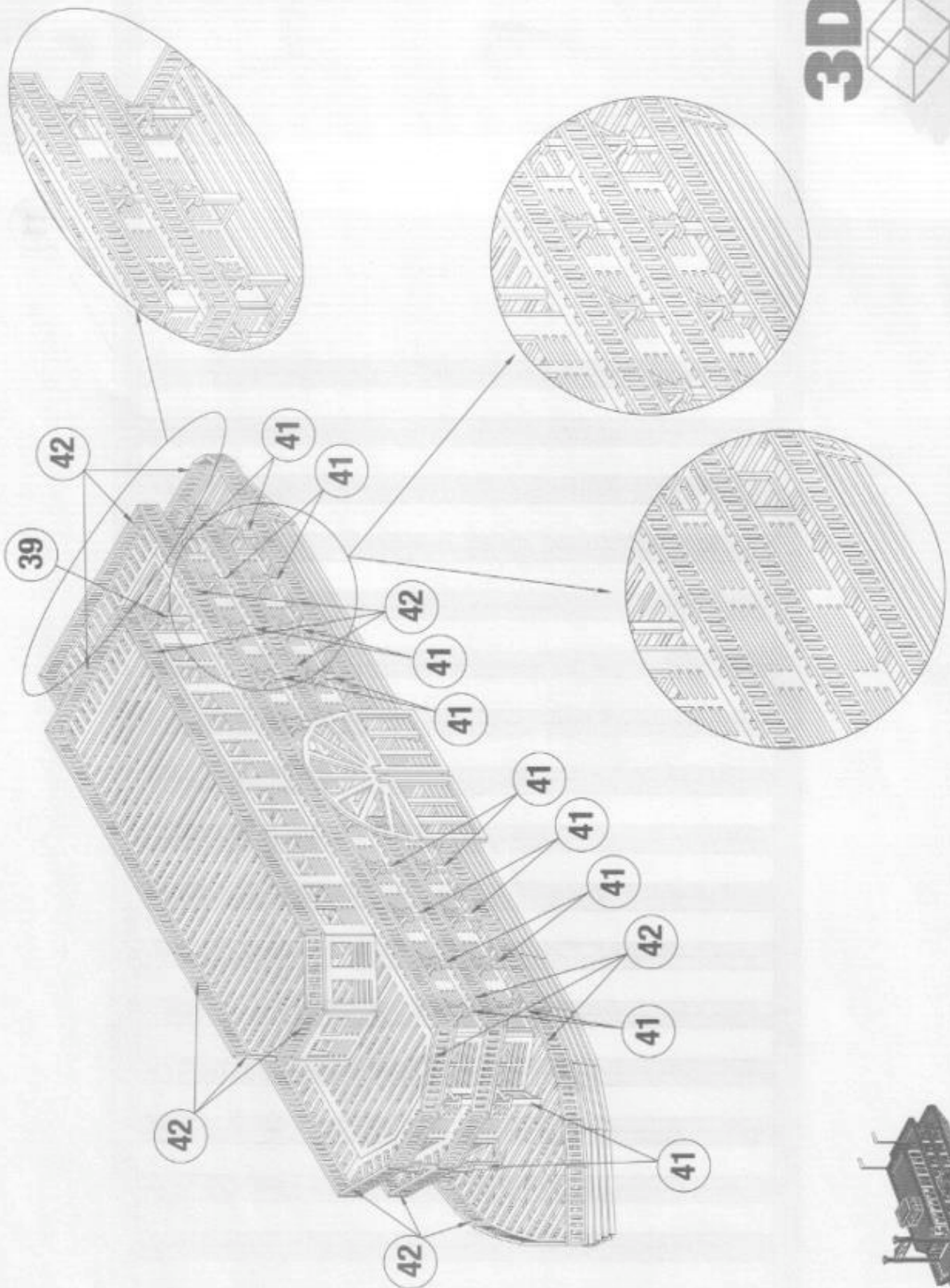

3D

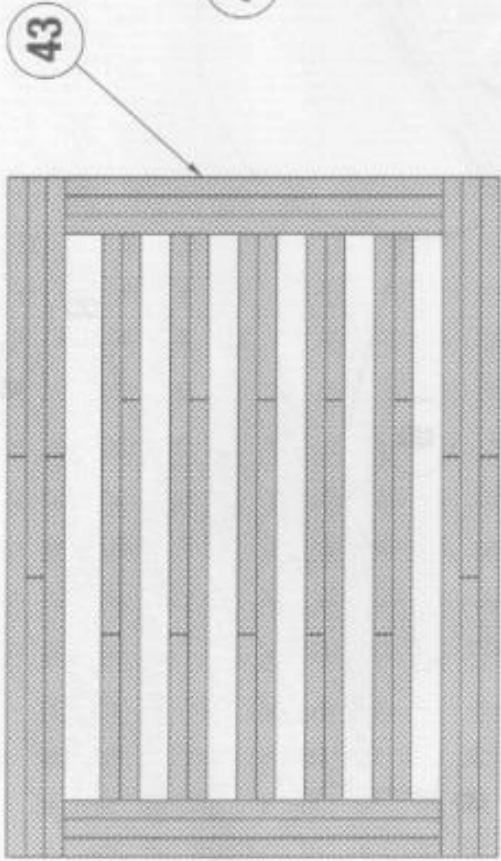
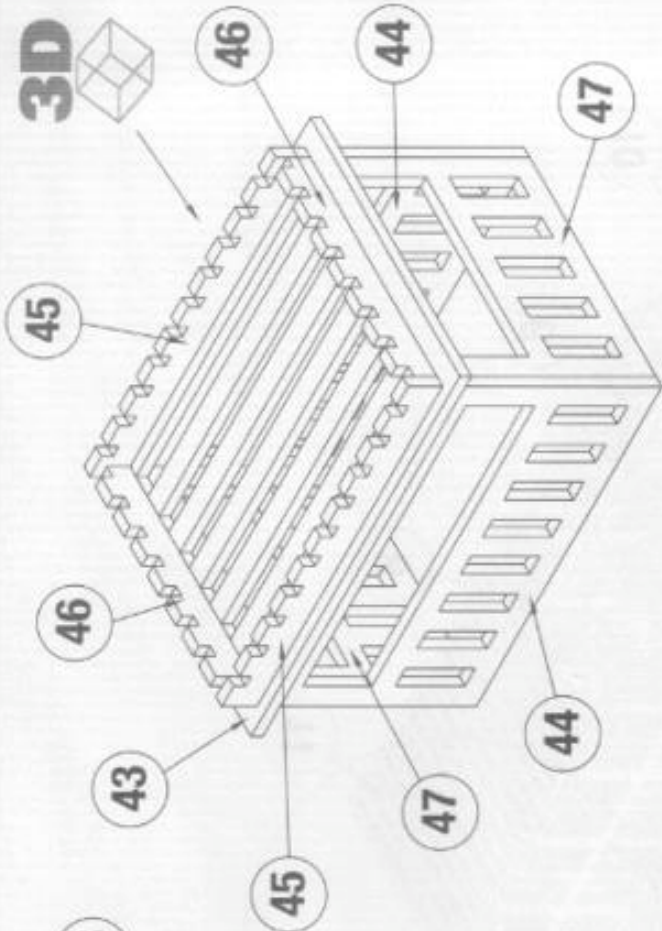

2x 44

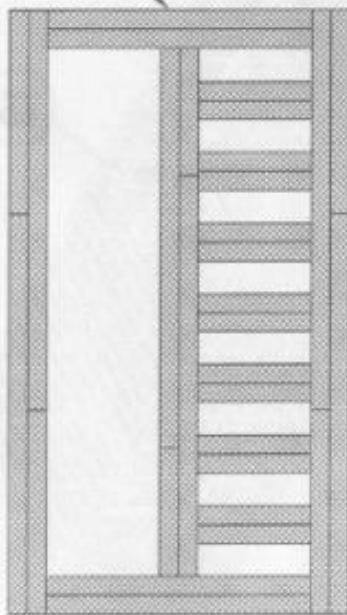

2x 45



2x 46



2x 47

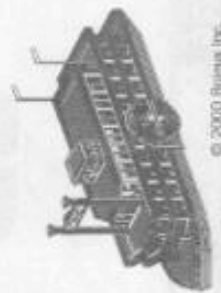
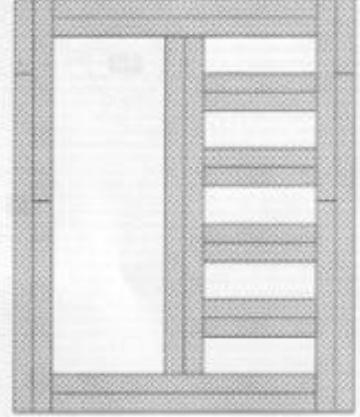

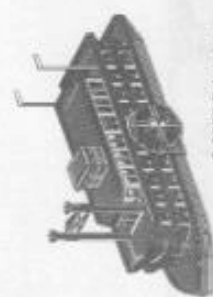
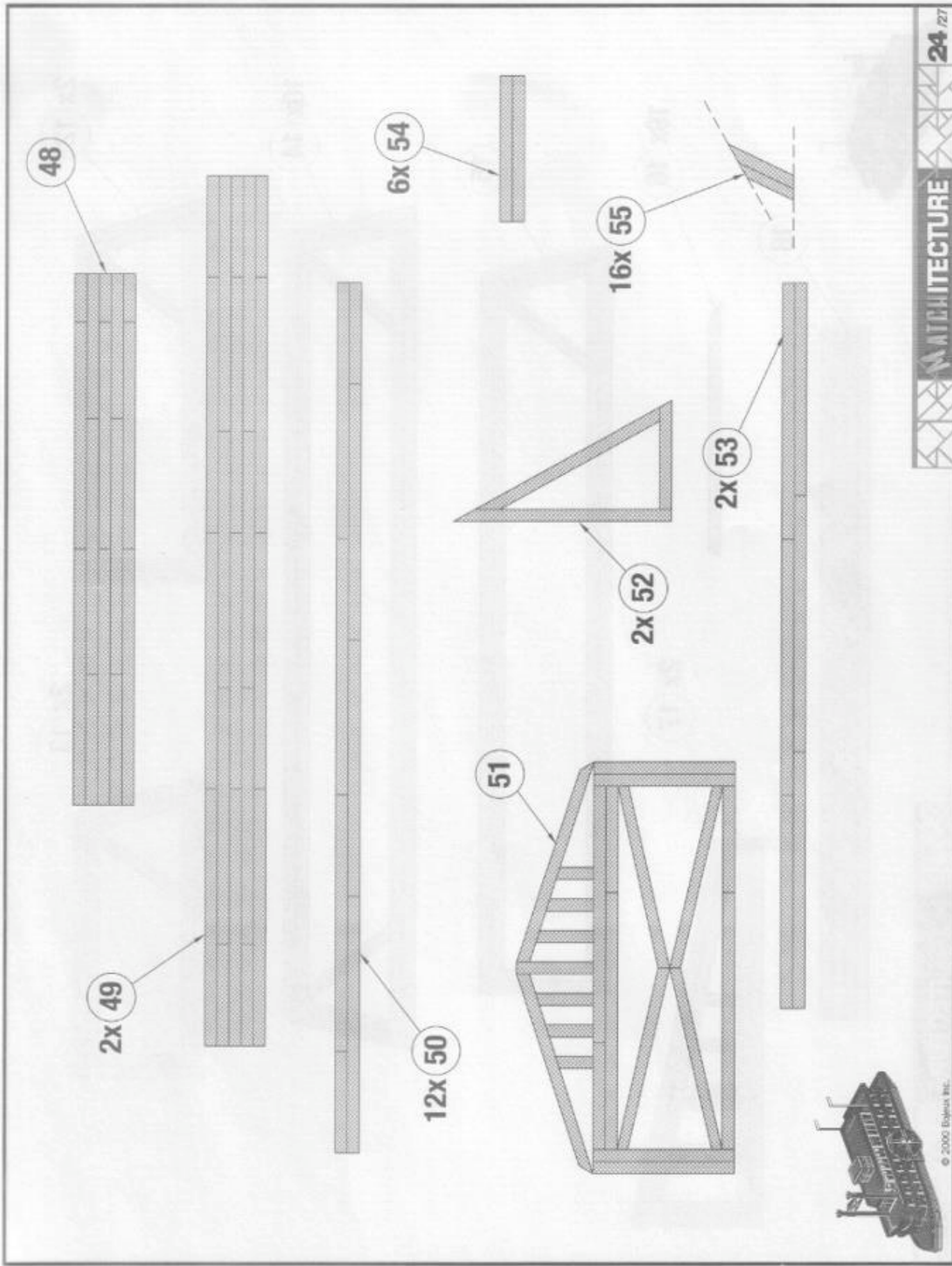

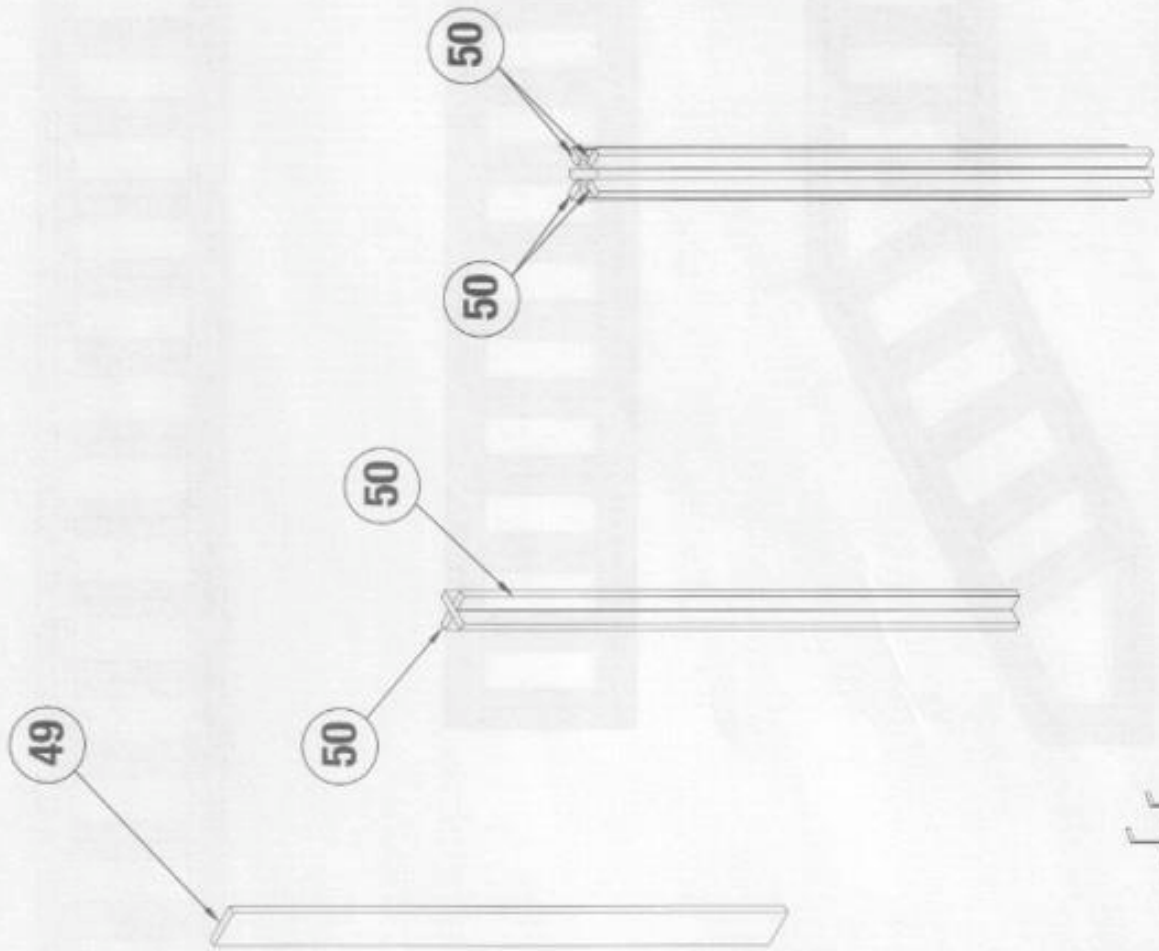
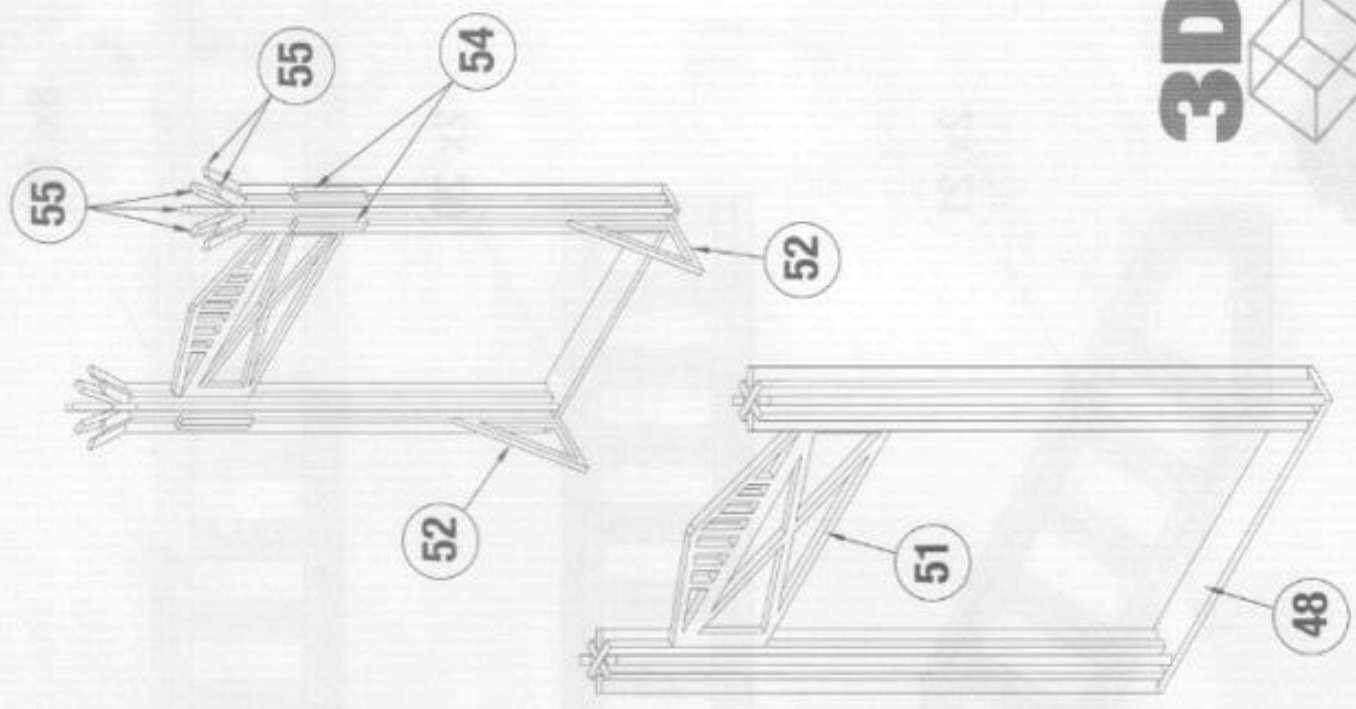

3D 

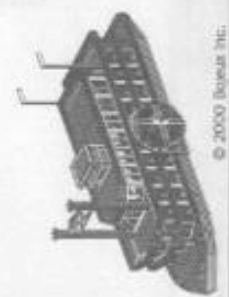

3D

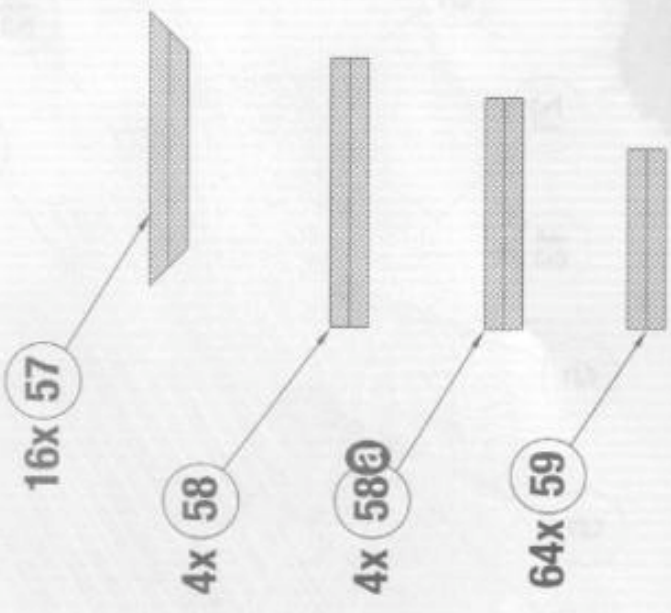
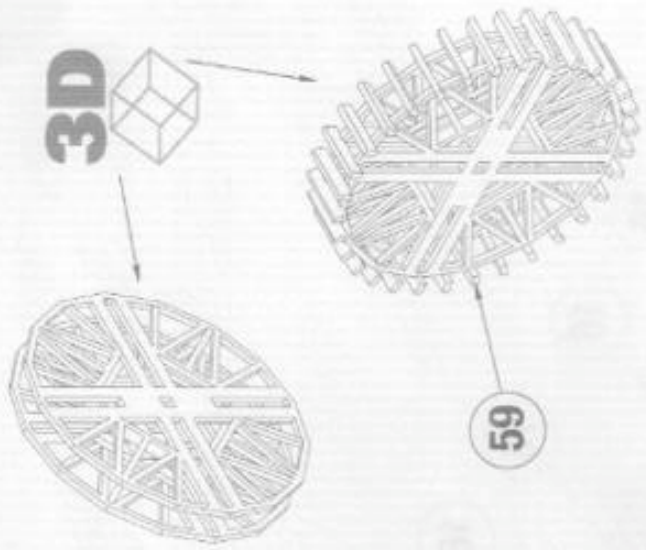

4x 56

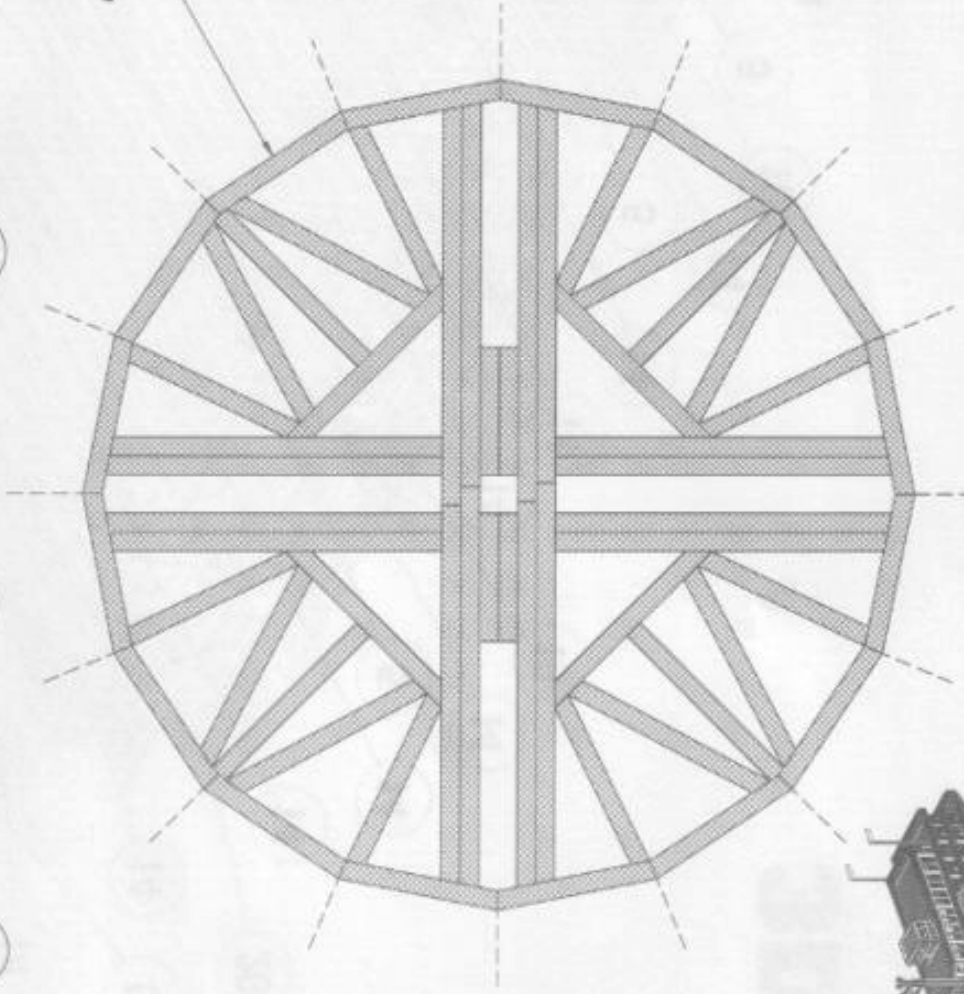

58



57

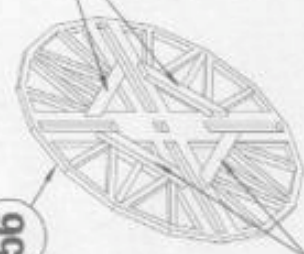

57

56

57

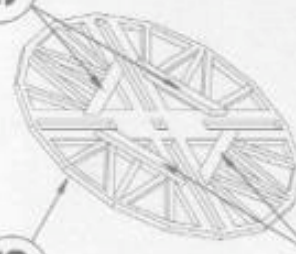

57

56

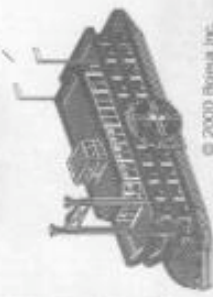

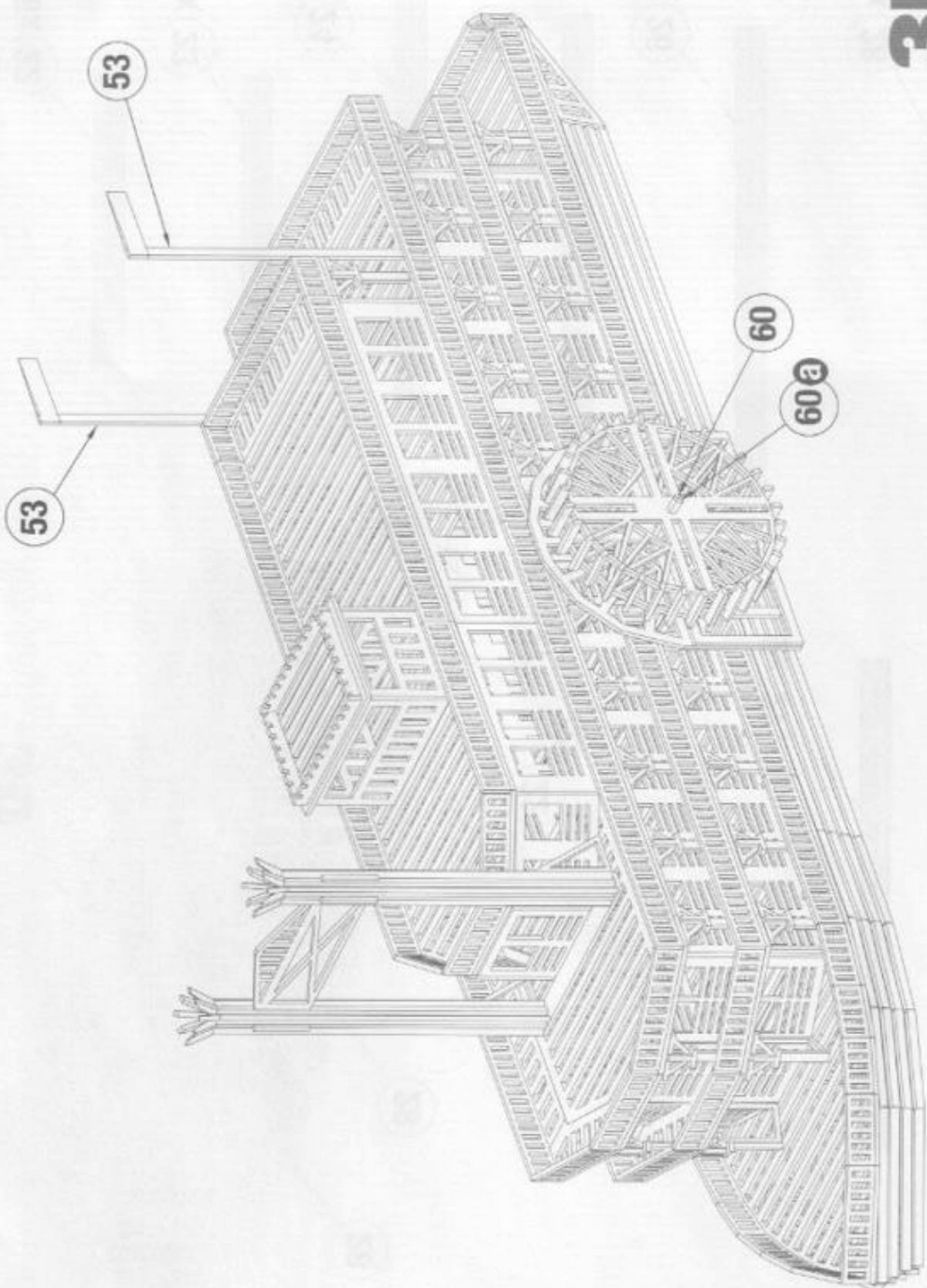

3D

